

## Axial Lead Transient Voltage Suppressors (TVS)

**3KP Series    5.0 To 190 V    3000W**

### Description

The 3KP series is designed specifically to protect sensitive electronic equipment from voltage transients induced by lightning and other transient voltage events.

### Features

- u Glass passivated chip junction in P600 Package
- u Low leakage
- u Uni and Bidirectional unit
- u Excellent clamping capability
- u 3000W Peak power capability at 10 × 1000µs waveform Repetition rate (duty cycle):0.01%
- u Fast response time: typically less than 1.0ps from 0 Volts to  $V_{BR}$  min
- u Typical  $I_R$  less than 5µA above 12V.
- u High Temperature soldering: 260°C/40 seconds at terminals
- u Typical maximum temperature coefficient  $\Delta V_{BR} = 0.1\% \times V_{BR}@25^\circ\text{C} \times \Delta T$
- u Plastic package has Underwriters Laboratory Flammability 94V-0
- u Matte tin lead-free Plated
- u Halogen free and RoHS compliant
- u Typical failure mode is short from over-specified voltage or current
- u Whisker test is conducted based on JEDEC JESD201A per its table 4a and 4c
- u IEC-61000-4-2 ESD 15kV(Air), 8kV (Contact)
- u ESD protection of data lines in accordance with IEC 61000-4-2 (IEC801-2)
- u EFT protection of data lines in accordance with IEC 61000-4-4 (IEC801-4)

Uni-directional

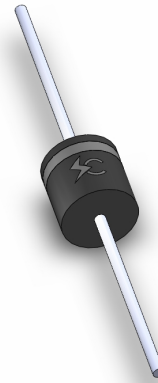

Bi-directional

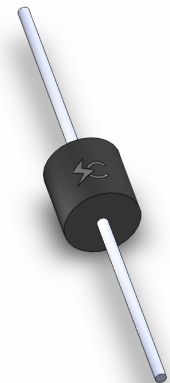

### Functional Diagram

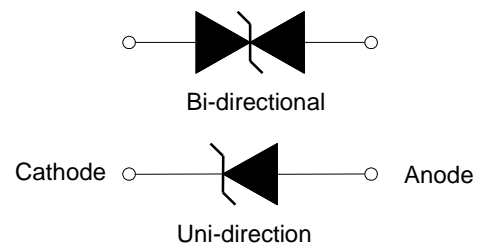

### Applications

TVS devices are ideal for the protection of I/O interfaces,  $V_{CC}$  bus and other vulnerable circuits used in Telecom, Computer, Industrial and Consumer electronic applications.

### Maximum Ratings ( $T_A=25^\circ\text{C}$ unless otherwise noted)

Parameter	Symbol	Value	Unit
Peak Pulse Power Dissipation with a 10/1000µs waveform (Fig.1)(Note 1), (Note 2)	$P_{PPM}$	3000	Watts
Peak Pulse Current with a 10/1000µs waveform.(Note1, Fig.3)	$I_{PP}$	See Next Table	Amps
Power Dissipation on Infinite Heat Sink at $T_L=75^\circ\text{C}$	$P_{M(AV)}$	6.5	Watt
Peak Forward Surge Current, 8.3ms Single Half Sine Wave (Note 3)	$I_{FSM}$	300	Amps
Maximum Instantaneous Forward Voltage at 25A for Unidirectional Only (Note 4)	$V_F$	3.5/5.0	Voltage
Operating junction and Storage Temperature Range.	$T_J, T_{STG}$	-55 to +150	$^\circ\text{C}$

### Notes:

1. Non-repetitive current pulse, per Fig. 3 and derated above  $T_A = 25^\circ\text{C}$  per Fig. 2.
2. Mounted on 5.0mm x 5.0mm (0.03mm thick) Copper Pads to each terminal.
3. 8.3ms single half sine-wave, or equivalent square wave, Duty cycle = 4 pulses per minutes maximum.
4.  $V_F < 3.5\text{V}$  for  $V_{BR} < 200\text{V}$  and  $V_F < 6.5\text{V}$  for  $V_{BR} > 201\text{V}$ .

## Axial Lead Transient Voltage Suppressors (TVS)

**3KP Series 5.0 To 190 V 3000W**
**Electrical Characteristics (T<sub>A</sub>=25°C unless otherwise noted)**

Part Number		Reverse Stand-Off Voltage V <sub>RWM</sub> (V)	Breakdown Voltage V <sub>BR</sub> (V) @I <sub>T</sub>		Test Current I <sub>T</sub> (mA)	Maximum Clamping Voltage V <sub>C</sub> @I <sub>PP</sub> (V)	Maximum Peak Pulse Current I <sub>PP</sub> (A)	Maximum Reverse Leakage I <sub>R</sub> @V <sub>RWM</sub> (μA)
Uni	Bi		MIN	MAX				
3KP5.0	3KP5.0C	5.0	6.40	7.30	50	9.6	312.50	1000
3KP5.0A	3KP5.0CA	5.0	6.40	7.00	50	9.2	326.09	1000
3KP6.0	3KP6.0C	6.0	6.67	8.15	50	11.4	263.16	1000
3KP6.0A	3KP6.0CA	6.0	6.67	7.37	50	10.3	291.26	1000
3KP6.5	3KP6.5C	6.5	7.22	8.82	50	12.3	243.90	500
3KP6.5A	3KP6.5CA	6.5	7.22	7.98	50	11.2	267.86	500
3KP7.0	3KP7.0C	7.0	7.78	9.51	50	13.3	225.56	200
3KP7.0A	3KP7.0CA	7.0	7.78	8.60	50	12.0	250.00	200
3KP7.5	3KP7.5C	7.5	8.33	10.20	5	14.3	209.79	100
3KP7.5A	3KP7.5CA	7.5	8.33	9.21	5	12.9	232.56	100
3KP8.0	3KP8.0C	8.0	8.89	10.90	5	15.0	200.00	50
3KP8.0A	3KP8.0CA	8.0	8.89	9.83	5	13.6	220.59	50
3KP8.5	3KP8.5C	8.5	9.44	11.50	5	15.9	188.68	25
3KP8.5A	3KP8.5CA	8.5	9.44	10.40	5	14.4	208.33	25
3KP9.0	3KP9.0C	9.0	10.00	12.20	5	16.9	177.51	10
3KP9.0A	3KP9.0CA	9.0	10.00	11.10	5	15.4	194.81	10
3KP10	3KP10C	10.0	11.10	13.60	5	18.8	159.57	5
3KP10A	3KP10CA	10.0	11.10	12.30	5	17.0	176.47	5
3KP11	3KP11C	11.0	12.20	14.90	5	20.1	149.25	5
3KP11A	3KP11CA	11.0	12.20	13.50	5	18.2	164.84	5
3KP12	3KP12C	12.0	13.30	16.30	5	22.0	136.36	5
3KP12A	3KP12CA	12.0	13.30	14.70	5	19.9	150.75	5
3KP13	3KP13C	13.0	14.40	17.60	5	23.8	126.05	5
3KP13A	3KP13CA	13.0	14.40	15.90	5	21.5	139.53	5
3KP14	3KP14C	14.0	15.60	19.10	5	25.8	116.28	5
3KP14A	3KP14CA	14.0	15.60	17.20	5	23.2	129.31	5
3KP15	3KP15C	15.0	16.70	20.40	5	26.9	111.52	5
3KP15A	3KP15CA	15.0	16.70	18.50	5	24.4	122.95	5
3KP16	3KP16C	16.0	17.80	21.80	5	28.8	104.17	5
3KP16A	3KP16CA	16.0	17.80	19.70	5	26.0	115.38	5
3KP17	3KP17C	17.0	18.90	23.10	5	30.5	98.36	5
3KP17A	3KP17CA	17.0	18.90	20.90	5	27.6	108.70	5
3KP18	3KP18C	18.0	20.00	24.40	5	32.2	93.17	5
3KP18A	3KP18CA	18.0	20.00	22.10	5	29.2	102.74	5
3KP19	3KP19C	19.0	21.13	25.76	5	34.0	88.21	5
3KP19A	3KP19CA	19.0	21.10	23.30	5	30.8	97.47	5
3KP20	3KP20C	20.0	22.20	27.10	5	35.8	83.80	5
3KP20A	3KP20CA	20.0	22.20	24.50	5	32.4	92.59	5
3KP22	3KP22C	22.0	24.40	29.80	5	39.4	76.14	5
3KP22A	3KP22CA	22.0	24.40	26.90	5	35.5	84.51	5
3KP24	3KP24C	24.0	26.70	32.60	5	43.0	69.77	5
3KP24A	3KP24CA	24.0	26.70	29.50	5	38.9	77.12	5
3KP26	3KP26C	26.0	28.90	35.30	5	46.6	64.38	5
3KP26A	3KP26CA	26.0	28.90	31.90	5	42.1	71.26	5
3KP28	3KP28C	28.0	31.10	38.00	5	50.0	60.00	5
3KP28A	3KP28CA	28.0	31.10	34.40	5	45.4	66.08	5
3KP30	3KP30C	30.0	33.30	40.70	5	53.5	56.07	5
3KP30A	3KP30CA	30.0	33.30	36.80	5	48.4	61.98	5
3KP33	3KP33C	33.0	36.70	44.90	5	59.0	50.85	5
3KP33A	3KP33CA	33.0	36.70	40.60	5	53.3	56.29	5
3KP36	3KP36C	36.0	40.00	48.90	5	64.3	46.66	5
3KP36A	3KP36CA	36.0	40.00	44.20	5	58.1	51.64	5
3KP40	3KP40C	40.0	44.40	54.30	5	71.4	42.02	5
3KP40A	3KP40CA	40.0	44.40	49.10	5	64.5	46.51	5
3KP43	3KP43C	43.0	47.80	58.40	5	76.7	39.11	5
3KP43A	3KP43CA	43.0	47.80	52.80	5	69.4	43.23	5

## Axial Lead Transient Voltage Suppressors (TVS)

**3KP Series 5.0 To 190 V 3000W**
**Electrical Characteristics (T<sub>A</sub>=25°C unless otherwise noted) (Continue)**

Part Number		Reverse Stand-Off Voltage V <sub>RWM</sub> (V)	Breakdown Voltage V <sub>BR</sub> (V) @I <sub>T</sub>		Test Current I <sub>T</sub> (mA)	Maximum Clamping Voltage V <sub>C</sub> @I <sub>PP</sub> (V)	Maximum Peak Pulse Current I <sub>PP</sub> (A)	Maximum Reverse Leakage I <sub>R</sub> @V <sub>RWM</sub> (μA)
Uni	Bi		MIN	MAX				
3KP45	3KP45C	45.0	50.00	61.10	5	80.3	37.36	5
3KP45A	3KP45CA	45.0	50.00	55.30	5	72.7	41.27	5
3KP48	3KP48C	48.0	53.30	65.10	5	85.5	35.09	5
3KP48A	3KP48CA	48.0	53.30	58.90	5	77.4	38.76	5
3KP51	3KP51C	51.0	56.70	69.30	5	91.1	32.93	5
3KP51A	3KP51CA	51.0	56.70	62.70	5	82.4	36.41	5
3KP54	3KP54C	54.0	60.00	73.30	5	96.3	31.15	5
3KP54A	3KP54CA	54.0	60.00	66.30	5	87.1	34.44	5
3KP58	3KP58C	58.0	64.40	78.70	5	103.0	29.13	5
3KP58A	3KP58CA	58.0	64.40	71.20	5	93.6	32.05	5
3KP60	3KP60C	60.0	66.70	81.50	5	107.0	28.04	5
3KP60A	3KP60CA	60.0	66.70	73.70	5	96.8	30.99	5
3KP64	3KP64C	64.0	71.10	86.90	5	114.0	26.32	5
3KP64A	3KP64CA	64.0	71.10	78.60	5	103.0	29.13	5
3KP70	3KP70C	70.0	77.80	95.10	5	125.0	24.00	5
3KP70A	3KP70CA	70.0	77.80	86.00	5	113.0	26.55	5
3KP75	3KP75C	75.0	83.30	102.00	5	134.0	22.39	5
3KP75A	3KP75CA	75.0	83.30	92.10	5	121.0	24.79	5
3KP78	3KP78C	78.0	86.70	106.00	5	139.0	21.58	5
3KP78A	3KP78CA	78.0	86.70	95.80	5	126.0	23.81	5
3KP80	3KP80C	80.0	88.96	108.80	5	143.2	20.95	5
3KP80A	3KP80CA	80.0	88.80	97.60	5	129.6	23.15	5
3KP85	3KP85C	85.0	94.40	115.00	5	151.0	19.87	5
3KP85A	3KP85CA	85.0	94.40	104.00	5	137.0	21.90	5
3KP90	3KP90C	90.0	100.00	122.00	5	160.0	18.75	5
3KP90A	3KP90CA	90.0	100.00	111.00	5	146.0	20.55	5
3KP100	3KP100C	100.0	111.00	136.00	5	179.0	16.76	5
3KP100A	3KP100CA	100.0	111.00	123.00	5	162.0	18.52	5
3KP110	3KP110C	110.0	122.00	149.00	5	196.0	15.31	5
3KP110A	3KP110CA	110.0	122.00	135.00	5	177.0	16.95	5
3KP120	3KP120C	120.0	133.00	163.00	5	214.0	14.02	5
3KP120A	3KP120CA	120.0	133.00	147.00	5	193.0	15.54	5
3KP130	3KP130C	130.0	144.00	176.00	5	231.0	12.99	5
3KP130A	3KP130CA	130.0	144.00	159.00	5	209.0	14.35	5
3KP140	3KP140C	140.0	155.68	190.40	5	250.6	11.97	5
3KP140A	3KP140CA	140.0	155.00	171.00	5	226.8	13.23	5
3KP150	3KP150C	150.0	167.00	204.00	5	268.0	11.19	5
3KP150A	3KP150CA	150.0	167.00	185.00	5	243.0	12.35	5
3KP160	3KP160C	160.0	178.00	218.00	5	287.0	10.45	5
3KP160A	3KP160CA	160.0	178.00	197.00	5	259.0	11.58	5
3KP170	3KP170C	170.0	189.00	231.00	5	304.0	9.87	5
3KP170A	3KP170CA	170.0	189.00	209.00	5	275.0	10.91	5
3KP180	3KP180C	180.0	201.00	244.80	5	322.2	9.31	5
3KP180A	3KP180CA	180.0	201.00	220.00	5	291.6	10.29	5
3KP190	3KP190C	190.0	211.21	258.40	5	340.1	8.82	5
3KP190A	3KP190CA	190.0	211.00	232.00	5	307.8	9.75	5

**Note:**

1. Suffix 'A' denotes 5% tolerance device. Without 'A' denotes 10% tolerance device
2. Add suffix 'C' or 'CA' after part number to specify Bi-directional devices
3. For Bi-Directional devices having V<sub>R</sub> of 10 volts and under, the I<sub>R</sub> limit is double

# Axial Lead Transient Voltage Suppressors (TVS)

3KP Series 5.0 To 190 V 3000W

Ratings and Characteristic Curves ( $T_A=25^\circ\text{C}$  unless otherwise noted)

Figure 1 - Peak Pulse Power Rating Curve

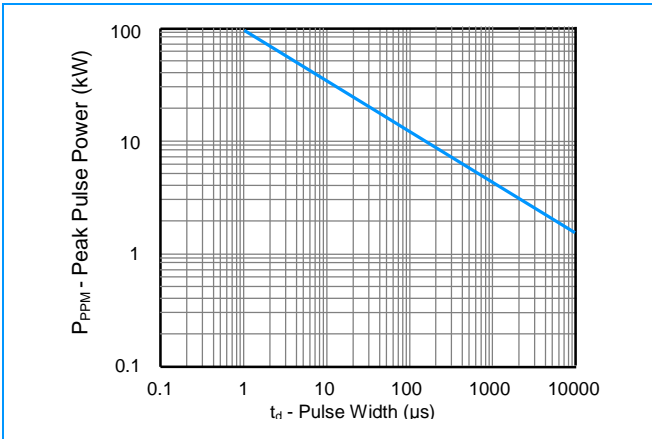

Figure 2 - Pulse Derating Curve

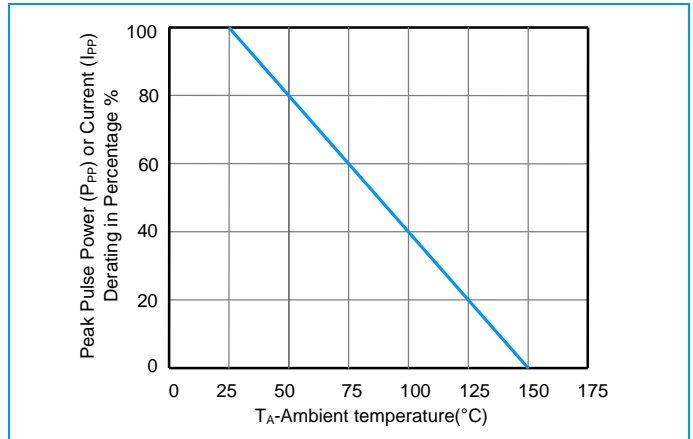

Figure 3 - Pulse Waveform

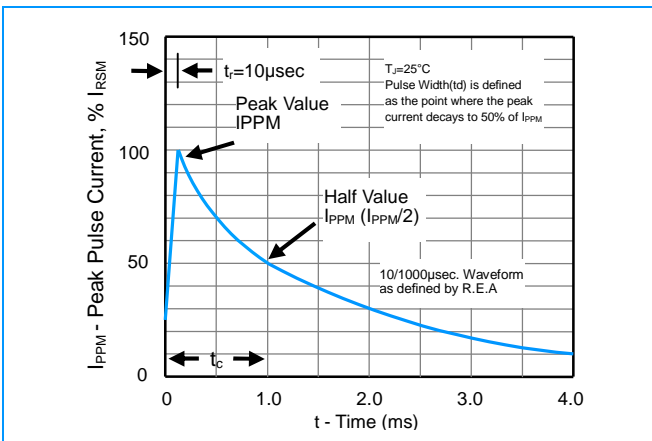

Figure 4 - Typical Junction Capacitance

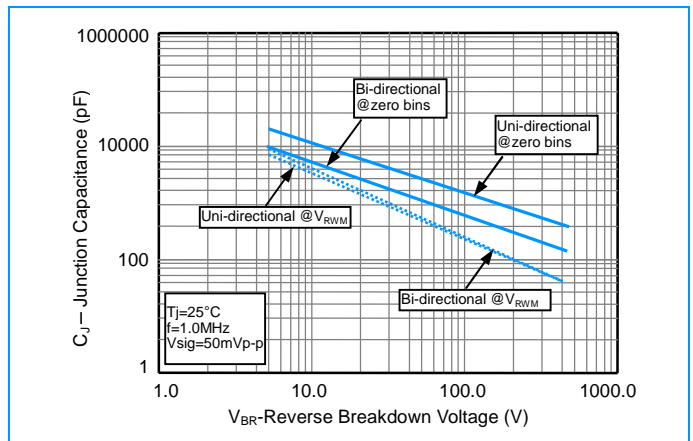

Figure 5 - Steady State Power Derating Curve

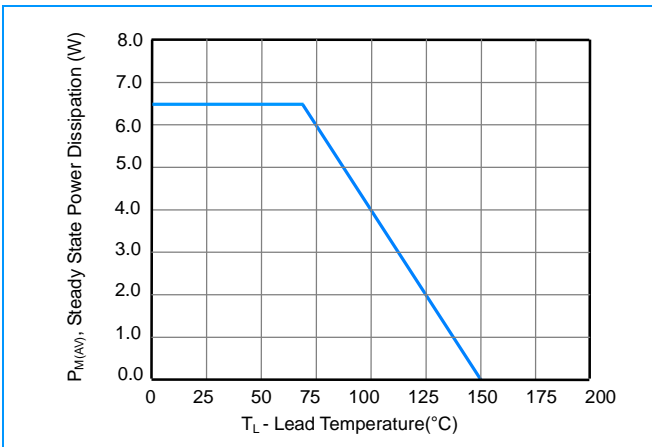
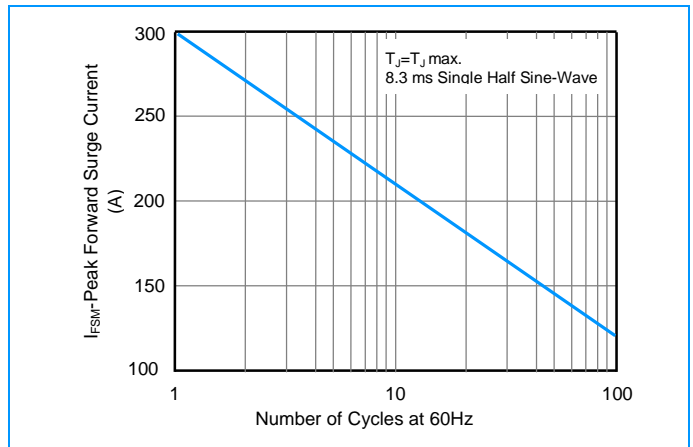

Figure 6 - Maximum Non-Repetitive Surge Current



# Axial Lead Transient Voltage Suppressors (TVS)

**3KP Series 5.0 To 190 V 3000W**

## I-V Curve Characteristics

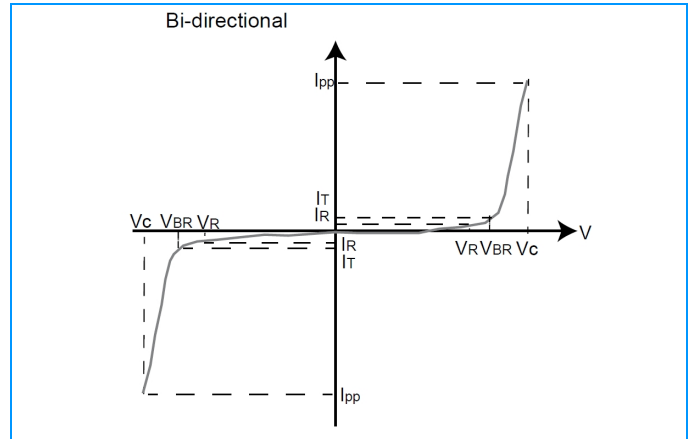
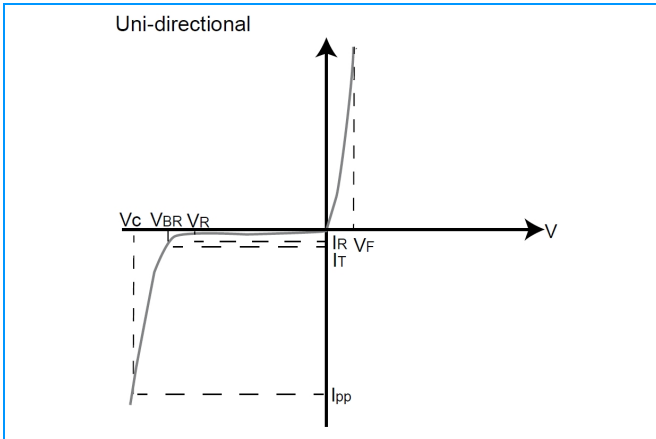

## Physical Specifications

<b>Weight</b>	0.07 ounce, 2.1 gram
<b>Case</b>	JEDEC R-6/P600 Molded Plastic over glass passivated junction
<b>Polarity</b>	Color band denotes cathode except Bipolar
<b>Terminal</b>	Matte Tin-plated leads, Solderable per JESD22-B102D

## Environmental Specifications

<b>Temperature Cycle</b>	JESD22-A104
<b>Pressure Cooker</b>	JESD22-A102
<b>High Temp. Storage</b>	JESD22-A103
<b>HTRB</b>	JESD22-A108
<b>Thermal Shock</b>	JESD22-A106

## Soldering Parameters

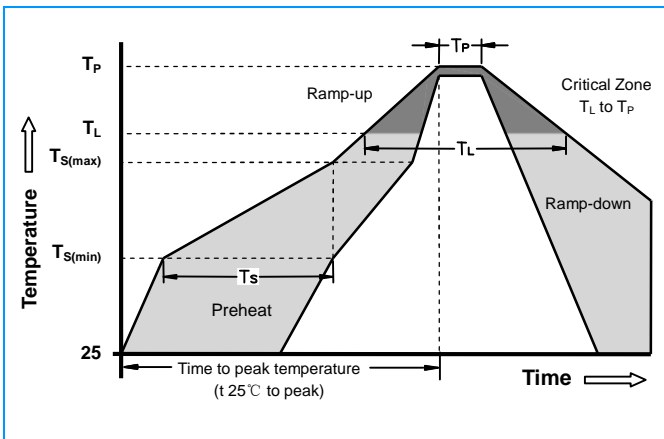

Reflow Condition		Lead-free assembly
Pre Heat	-Temperature Min ( $T_{s(min)}$ )	150°C
	-Temperature Max ( $T_{s(max)}$ )	200°C
	- Time (min to max) ( $t_s$ )	60 -180 Seconds
Average ramp up rate ( Liquidus Temp $T_L$ ) to peak		3°C/second max
$T_{s(max)}$ to $T_L$ - Ramp-up Rate		3°C/second max
Reflow	- Temperature ( $T_L$ ) (Liquidus)	217°C
	- Time (min to max) ( $t_s$ )	60 -150 Seconds
Peak Temperature ( $T_P$ )		260 +0/-5°C
Time within 5°C of actual peak Temperature ( $t_p$ )		20 -40 Seconds
Ramp-down Rate		6°C/second max
Time 25°C to peak Temperature ( $T_P$ )		8 minutes Max
Do not exceed		280°C

# Axial Lead Transient Voltage Suppressors (TVS)

**3KP Series 5.0 To 190 V 3000W**

## Dimensions

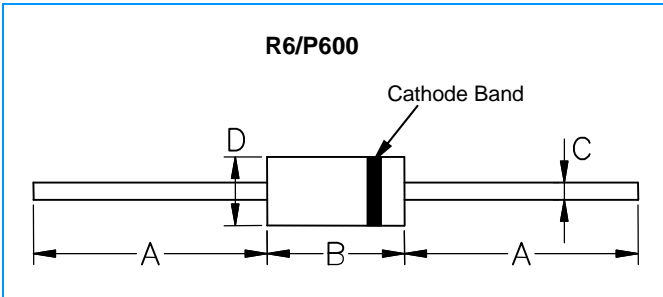

Dimensions	Inches		Millimeters	
	Min	Max	Min	Max
<b>A</b>	1.000	-	25.40	-
<b>B</b>	0.340	0.360	8.64	9.14
<b>C</b>	0.048	0.052	1.22	1.32
<b>D</b>	0.340	0.360	8.64	9.14

## Part Numbering

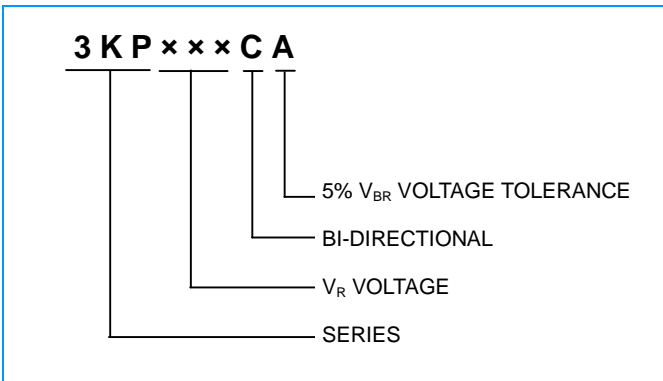

## Part Marking

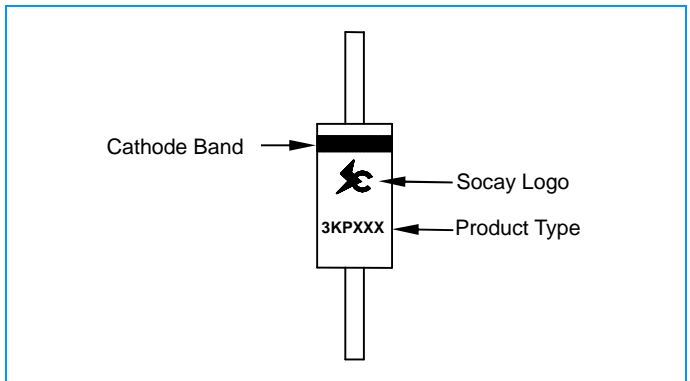

## Packaging

Part Number	Component Package	Quantity	Packaging Option
3KPXXXXX	R6/P600	200	Box

## Packaging Dimensions Unit: Inches (Millimeters)

