

770030-1 ✓ ACTIVE

MATE-N-LOK | Universal MATE-N-LOK

TE Internal #: 770030-1

Rectangular Power Connectors, Housing, Receptacle, Wire-to-Wire / Wire-to-Panel, 15 Position, 6.35 mm [.25 in] Centerline, Universal MATE-N-LOK

[View on TE.com >](#)



Connectors > Power Connectors > Rectangular Power > Rectangular Power Connectors

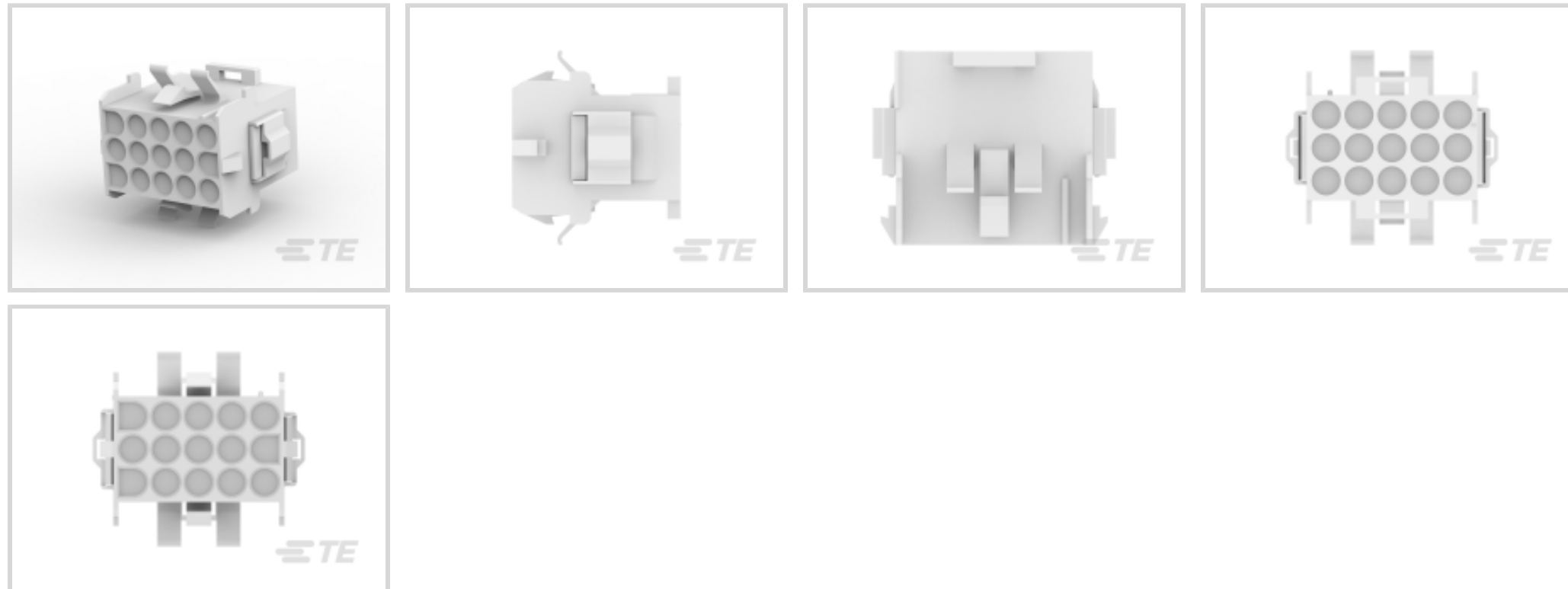

Rectangular Power Connector Type: **Housing**

Connector & Housing Type: **Receptacle**

Connector System: **Wire-to-Panel, Wire-to-Wire**

Number of Positions: **15**

Centerline (Pitch): **6.35 mm [.25 in]**

Features

Product Type Features

Assembly Requirement	Unassembled Kit
Rectangular Power Connector Type	Housing
Connector & Housing Type	Receptacle
Connector System	Wire-to-Panel, Wire-to-Wire
Sealable	No
Connector & Contact Terminates To	Wire & Cable

Configuration Features

Number of Positions	15
Number of Rows	3

Electrical Characteristics

Operating Voltage	600 VAC
-------------------	---------

Contact Features

Multiple Contact Types	Without
Contact Layout	Matrix



Contact Retention Within Housing	Without
----------------------------------	---------

Contact Type	Pin
--------------	-----

Termination Features

Termination Method to Wire & Cable	Crimp
------------------------------------	-------

Mechanical Attachment

Panel Mount Feature	With
---------------------	------

Panel Mount Feature Type	Latches
--------------------------	---------

Connector Mounting Type	Panel Mount
-------------------------	-------------

Housing Features

Centerline (Pitch)	6.35 mm [.25 in]
--------------------	------------------

Housing Color	White
---------------	-------

Housing Material	Nylon GF
------------------	----------

Dimensions

Panel Thickness (Recommended)	.76 – 2.29 mm [.76 – 2.29 in]
-------------------------------	-------------------------------

Product Width	21.46 mm
---------------	----------

Product Length	33.02 mm
----------------	----------

Row-to-Row Spacing	6.35 mm [.25 in]
--------------------	------------------

Usage Conditions

Operating Temperature Range	-55 – 120 °C [-67 – 248 °F]
-----------------------------	-----------------------------

Operation/Application

Circuit Application	Power & Signal
---------------------	----------------

Industry Standards

CSA Rating	Certified, LR 7189
------------	--------------------

UL Rating	Recognized
-----------	------------

Compatible With Agency/Standards Products	CSA, UL, VDE
---	--------------

Compatible With Approved Standards Products	UL E28476
---	-----------

UL Flammability Rating	UL 94V-0
------------------------	----------

Glow Wire Rating	Standard Part - Not Glow Wire
------------------	-------------------------------

Packaging Features

Packaging Quantity	1
--------------------	---

Packaging Method	Package
------------------	---------



Product Compliance

[For compliance documentation, visit the product page on TE.com>](#)

EU RoHS Directive 2011/65/EU	Compliant
EU ELV Directive 2000/53/EC	Compliant
China RoHS 2 Directive MIIT Order No 32, 2016	No Restricted Materials Above Threshold
EU REACH Regulation (EC) No. 1907/2006	Current ECHA Candidate List: JUNE 2024 (241) Candidate List Declared Against: JUNE 2024 (241) Does not contain REACH SVHC
Halogen Content	Low Halogen - Br, Cl, F, I < 900 ppm per homogenous material. Also BFR/CFR/PVC Free
Solder Process Capability	Not applicable for solder process capability

Product Compliance Disclaimer

This information is provided based on reasonable inquiry of our suppliers and represents our current actual knowledge based on the information they provided. This information is subject to change. The part numbers that TE has identified as EU RoHS compliant have a maximum concentration of 0.1% by weight in homogenous materials for lead, hexavalent chromium, mercury, PBB, PBDE, DBP, BBP, DEHP, DIBP, and 0.01% for cadmium, or qualify for an exemption to these limits as defined in the Annexes of Directive 2011/65/EU (RoHS2). Finished electrical and electronic equipment products will be CE marked as required by Directive 2011/65/EU. Components may not be CE marked. Additionally, the part numbers that TE has identified as EU ELV compliant have a maximum concentration of 0.1% by weight in homogenous materials for lead, hexavalent chromium, and mercury, and 0.01% for cadmium, or qualify for an exemption to these limits as defined in the Annexes of Directive 2000/53/EC (ELV). Regarding the REACH Regulation, the information TE provides on SVHC in articles for this part number is based on the latest European Chemicals Agency (ECHA) 'Guidance on requirements for substances in articles' posted at this URL: <https://echa.europa.eu/guidance-documents/guidance-on-reach>

Compatible Parts

 <p>TE Part # 770253-3 UMNL II SOK PTPPHBZ LP 24-18</p>	 <p>TE Part # 770247-3 UMNL II SOK PTPPHBZ LP 12-10</p>	 <p>TE Part # 770252-1 UMNL II PIN PTPBR LP 24-18</p>	 <p>TE Part # 1-770250-0 UMNL II PIN SN/AUNI/BR LP20-14</p>
--	--	--	--



TE Part # 770250-1
UMNL II PIN PTPBR LP 20-14



TE Part # 770251-3
UMNL II SOK PTPPHBZ LP 20-14



TE Part # 350736-1
15P UMNL PLUG HSG



TE Part # 1-770005-0
UMNL II PIN AUSN/NI/BR



TE Part # 770043-1
15P UMNL II PLUG-FRONT 94VO



TE Part # 770044-1
15P UMNL II PLUG REAR 94VO



TE Part # 770023-1
15P UMNLII IN-LNE PLUG HSG KIT



TE Part # 1-770009-0
UMNL II PIN AUSN/NI/BR



TE Part # 1-770247-0
UMNL II SOK SN/AUNI/PHBZ LP



TE Part # 770003-3
UMNL II PIN PTPPHBZ



TE Part # 1-770010-0
UMNL II SOK SN/AUNI/PHBZ LF



TE Part # 770010-3
UMNL II SOK PTPPHBZ



TE Part # 770004-3
UMNL II SOK PTPPHBZ



TE Part # 770005-1
UMNL II PIN PTPBR



TE Part # 770006-3
UMNL II SOK PTPPHBZ



TE Part # 770008-3
UMNL II SOK PTPPHBZ

Also in the Series | **Universal MATE-N-LOK**



Circular Power Connectors(2)



Connector Caps & Covers(34)

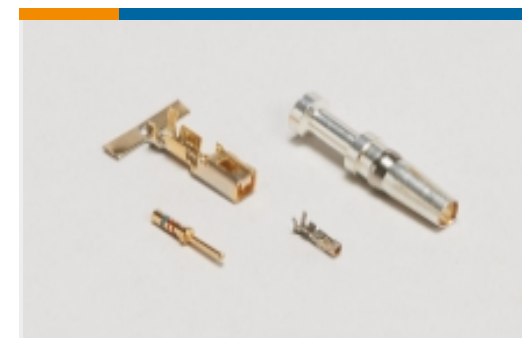

Connector Contacts(209)



Connector Hardware(12)

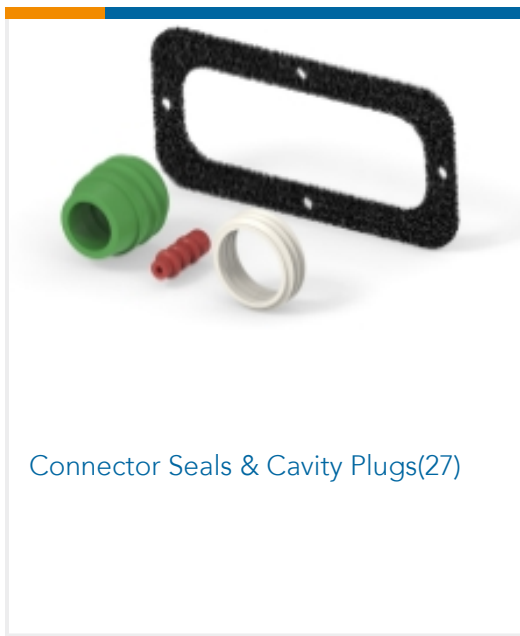

Connector Seals & Cavity Plugs(27)

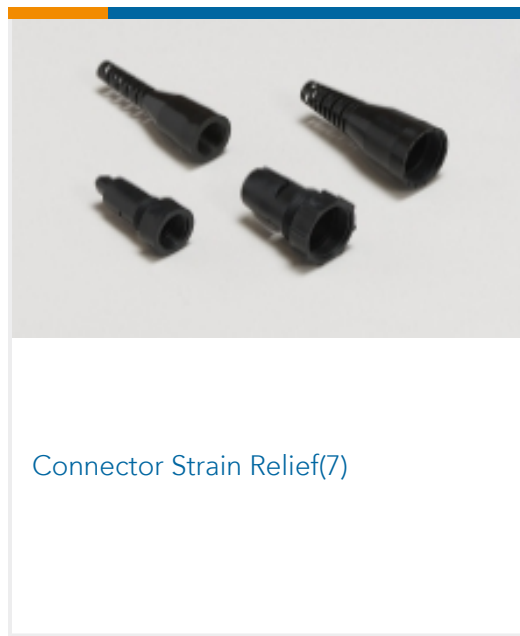

Connector Strain Relief(7)

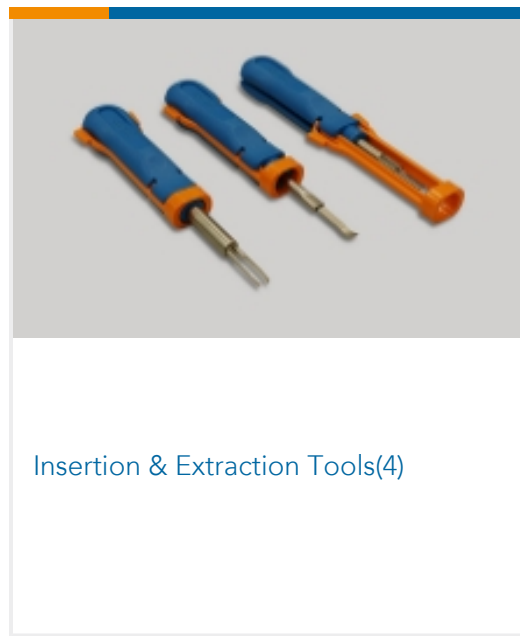

Insertion & Extraction Tools(4)

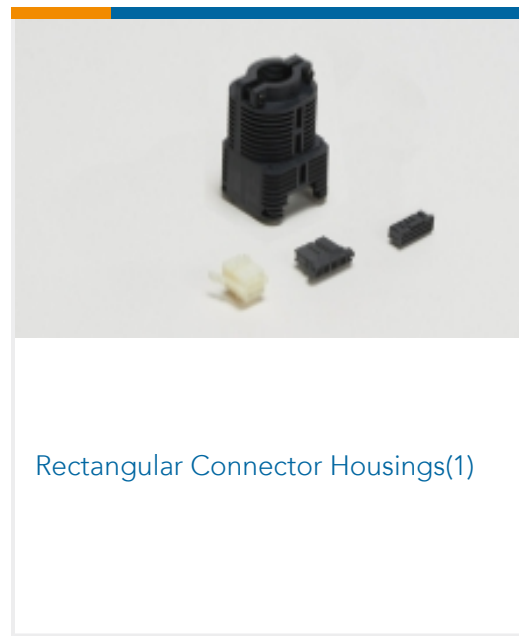

Rectangular Connector Housings(1)



Rectangular Power Connectors(672)

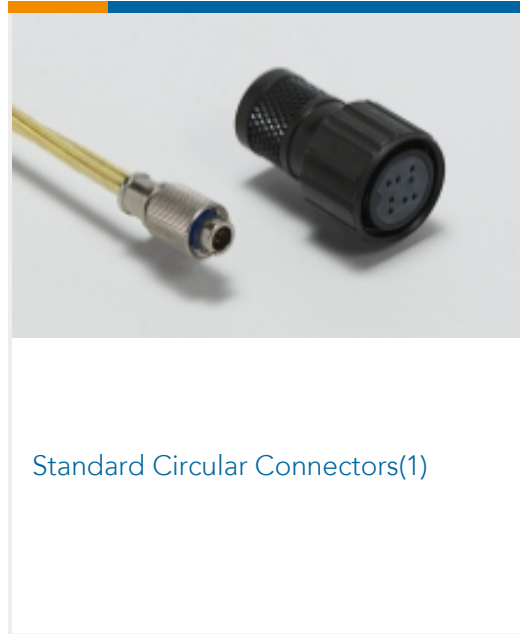

Standard Circular Connectors(1)

Customers Also Bought



TE Part #770028-1
09P UMNLII IN-LINE CAP HSG KIT



TE Part #770026-1
04P UMNLII IN-LINE CAP HSG KIT



TE Part #770024-1
02P UMNLII IN-LINE CAP HSG KIT



TE Part #770021-1
09P UMNLII IN-LINE PLUG HSG KIT



TE Part #770027-1
06P UMNLII IN-LINE CAP HSG KIT



TE Part #770017-1
02P UMNLII IN-LINE PLUG HSG KIT



TE Part #770020-1
06P UMNLII IN-LINE PLUG HSG KIT



TE Part #770007-1
UMNL II PIN PTPBR



TE Part #1217043-1
250 FASTON,REC.,14-10 AWG,TPBR



TE Part #1803450-3
ANVIL, AMPLIVAR SPLICE

Documents



Product Drawings

15P UMNLI IN-LINE CAP HSG KIT

English

CAD Files

3D PDF

3D

Customer View Model

[ENG_CVM_CVM_770030-1_E.2d_dxf.zip](#)

English

Customer View Model

[ENG_CVM_CVM_770030-1_E.3d_igs.zip](#)

English

Customer View Model

[ENG_CVM_CVM_770030-1_E.3d_stp.zip](#)

English

By downloading the CAD file I accept and agree to the [Terms and Conditions](#) of use.

Datasheets & Catalog Pages

SOFT_SHELL_PIN_SOCKET_CONNECTORS_STANDARD_DENSITY

English

Product Specifications

Application Specification

English

Instruction Sheets

Instruction Sheet (U.S.)

English

Agency Approvals

VDE Certificate

English
