

41800 ✓ ACTIVE

FASTON | FASTON 250

TE Internal #: 41800

Quick Disconnects, Receptacle, 18 – 12 AWG Wire Size, .82 – 3.31 mm² Wire Size, Mating Tab Width 6.35 mm [.25 in], Flag, Phosphor Bronze, FASTON 250

[View on TE.com >](#)



Terminals & Splices > Quick Disconnects

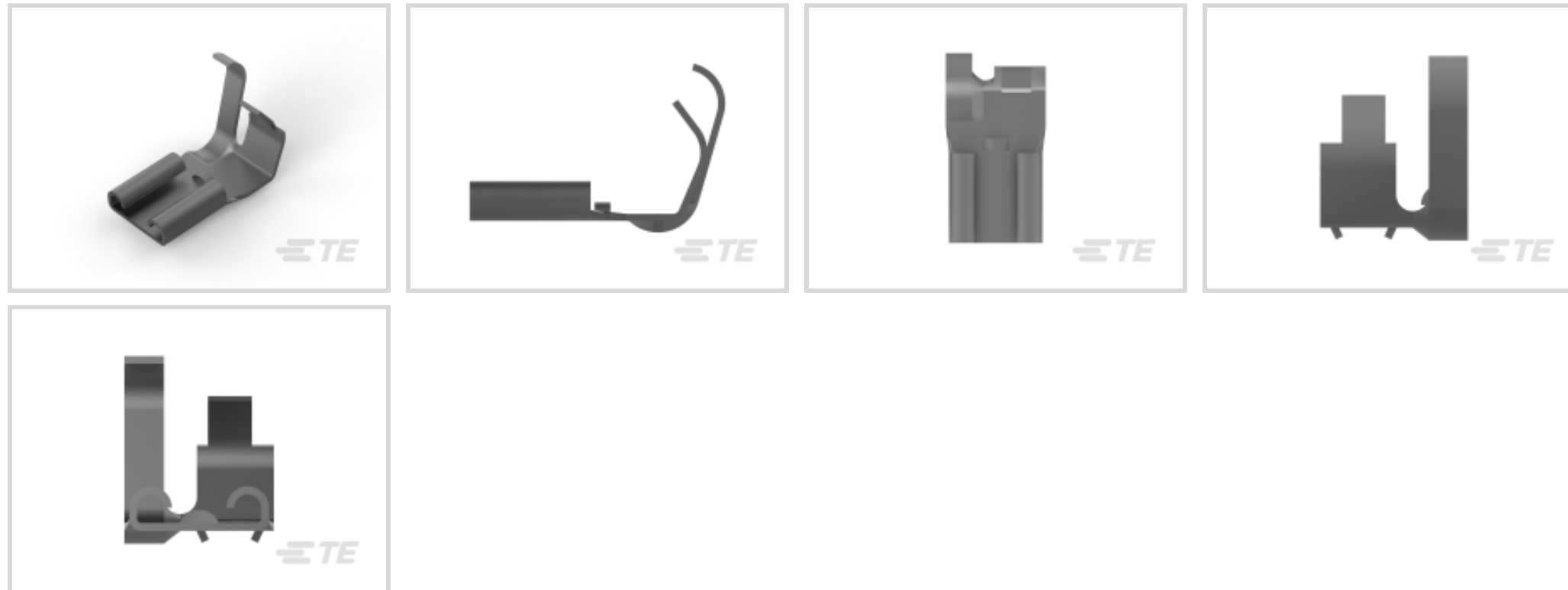

Quick Disconnect Terminal Type: **Receptacle**

Wire Size: .82 – 3.31 mm²

Mating Tab Width: 6.35 mm [.25 in]

Mating Tab Thickness: .81 mm [.032 in]

Features

Product Type Features

Insertion Force	Normal
-----------------	--------

Configuration Features

Connection Capacity	Single
---------------------	--------

Compatible With Wire & Cable Type	Discrete Wire
-----------------------------------	---------------

Contact Features

Quick Disconnect Terminal Type	Receptacle
--------------------------------	------------

Mating Tab Width	6.35 mm [.25 in]
------------------	------------------

Mating Tab Thickness	.81 mm [.032 in]
----------------------	------------------

Terminal Orientation	Flag
----------------------	------

Contact Base Material	Phosphor Bronze
-----------------------	-----------------

Terminal Plating Material	Tin
---------------------------	-----

Crimp Type	Tab-Lok
------------	---------

Barrel Type	Open
-------------	------

Termination Features



Product Terminates To	Wire & Cable
-----------------------	--------------

Mechanical Attachment

Wire Insulation Support	With
-------------------------	------

Mating Retention Type	Dimple
-----------------------	--------

Dimensions

Terminal Material Thickness	.46 mm[.018 in]
-----------------------------	-----------------

Product Length	17.02 mm[.67 in]
----------------	------------------

Compatible Insulation Diameter Range	2.79 – 5.33 mm[.11 – .21 in]
--------------------------------------	------------------------------

Wire Size	.82 – 3.31 mm ²
-----------	----------------------------

Usage Conditions

Insulation Option	Uninsulated
-------------------	-------------

Operating Temperature Range	-40 – 110 °C[-40 – 230 °F]
-----------------------------	----------------------------

Industry Standards

Compatible With Agency/Standards Products	CSA, UL
---	---------

Packaging Features

Packaging Quantity	4000
--------------------	------

Packaging Method	Strip/Reel
------------------	------------

Other

Line	Premier
------	---------

Product Compliance

[For compliance documentation, visit the product page on TE.com>](#)

EU RoHS Directive 2011/65/EU	Compliant
------------------------------	-----------

EU ELV Directive 2000/53/EC	Compliant
-----------------------------	-----------

China RoHS 2 Directive MIIT Order No 32, 2016	No Restricted Materials Above Threshold
---	---

EU REACH Regulation (EC) No. 1907/2006	Current ECHA Candidate List: JUNE 2024 (241) Candidate List Declared Against: JAN 2024 (240) Does not contain REACH SVHC
--	--







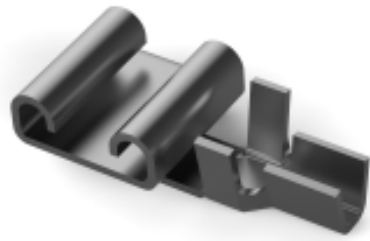
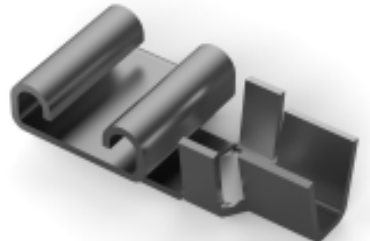
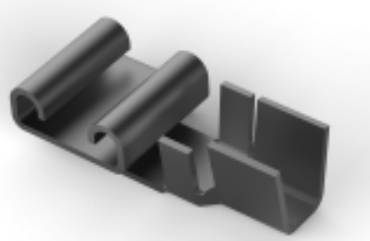

Halogen Content	Low Halogen - Br, Cl, F, I < 900 ppm per homogenous material. Also BFR/CFR/PVC Free
-----------------	---

Solder Process Capability	Not applicable for solder process capability
---------------------------	--

Product Compliance Disclaimer

This information is provided based on reasonable inquiry of our suppliers and represents our current actual knowledge based on the information they provided. This information is subject to change. The part numbers that TE has identified as EU RoHS compliant have a maximum concentration of 0.1% by weight in homogenous materials for lead, hexavalent chromium, mercury, PBB, PBDE, DBP, BBP, DEHP, DIBP, and 0.01% for cadmium, or qualify for an exemption to these limits as defined in the Annexes of Directive 2011/65/EU (RoHS2). Finished electrical and electronic equipment products will be CE marked as required by Directive 2011/65/EU. Components may not be CE marked. Additionally, the part numbers that TE has identified as EU ELV compliant have a maximum concentration of 0.1% by weight in homogenous materials for lead, hexavalent chromium, and mercury, and 0.01% for cadmium, or qualify for an exemption to these limits as defined in the Annexes of Directive 2000/53/EC (ELV). Regarding the REACH Regulation, the information TE provides on SVHC in articles for this part number is based on the latest European Chemicals Agency (ECHA) 'Guidance on requirements for substances in articles' posted at this URL: <https://echa.europa.eu/guidance-documents/guidance-on-reach>

Compatible Parts

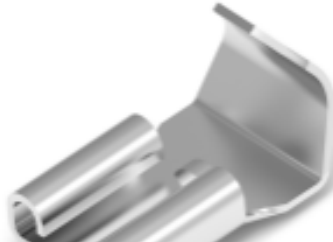
 <p>TE Part # 63137-1 250 FASTON FLAG REC 20-16 AWG TPBZ</p>	 <p>TE Part # 61188-1 250 FASTON FLAG REC 16-12 AWG TPBZ</p>	 <p>TE Part # 61187-1 250 FASTON FLAG REC 12-10 AWG PHBZ</p>	 <p>TE Part # 62056-6 250 FASTON FLAG REC 18-12 AWG TPBZ</p>
 <p>TE Part # 62056-7 250 FASTON FLAG REC 18-12 AWG TPBZ</p>	 <p>TE Part # 60274-2 250 FASTON FLAG REC 18-12 AWG TPBZ</p>	 <p>TE Part # 2232111-1 250 FASTON, FLAG, REC., 12-20 AWG, TPBR</p>	 <p>TE Part # 1852633-1 EAPOHB160TABLOCK1800 LM/G- HINGE BAR</p>
 <p>TE Part # 1855041-1 HINGE BAR F.A. EMPO160TAB1800 LM & G</p>	 <p>TE Part # 2232111-2 250 FASTON, FLAG, REC., 12-20 AWG, BR</p>	 <p>TE Part # 2232111-3 250 FASTON, FLAG, REC., 12-20 AWG, TPBR</p>	 <p>TE Part # 62056-2 250 FASTON FLAG REC 18-12 AWG SPBZ</p>

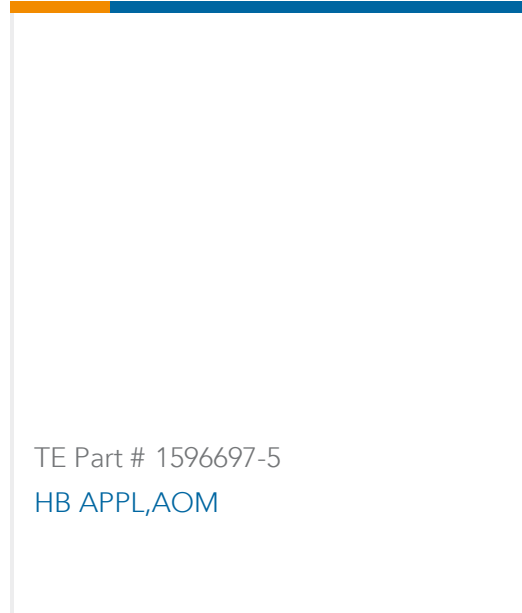
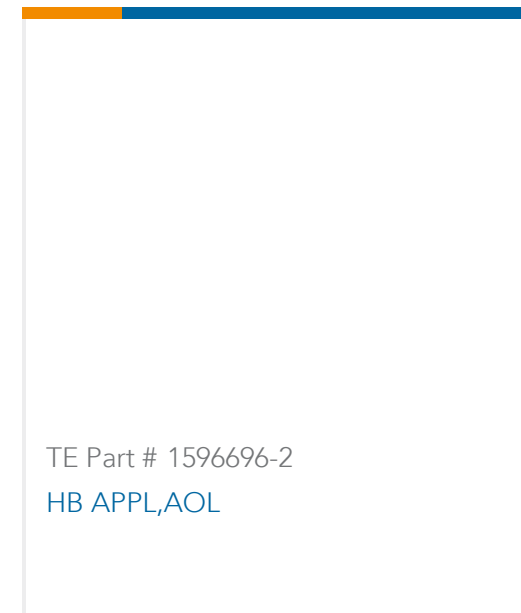

Also in the Series | **FASTON 250**

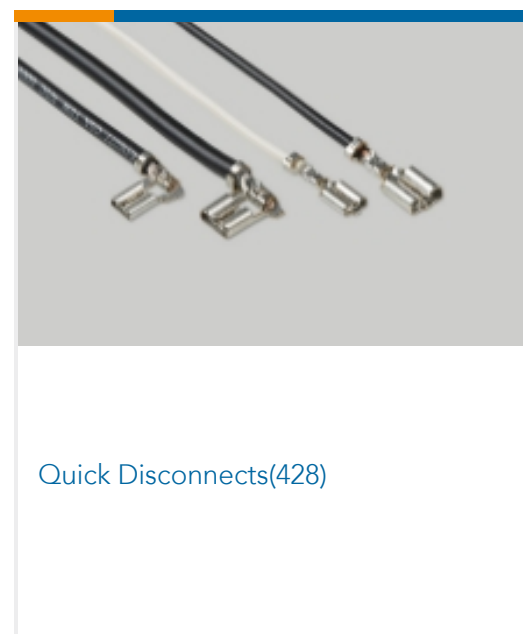
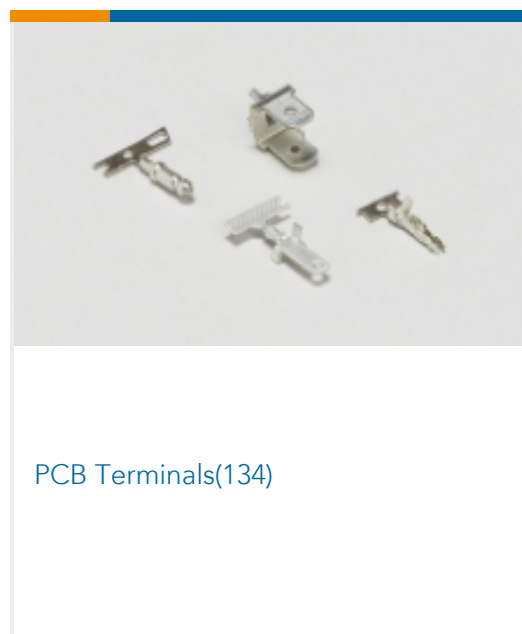
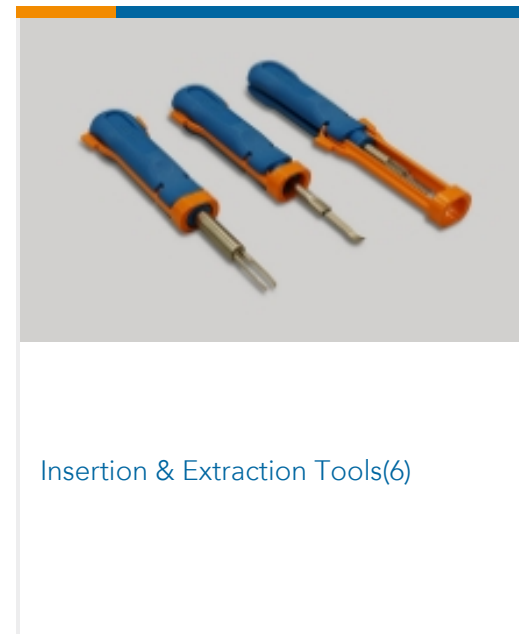
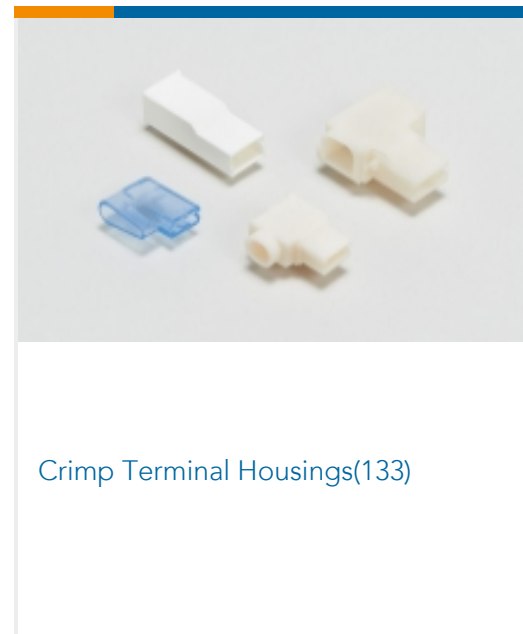
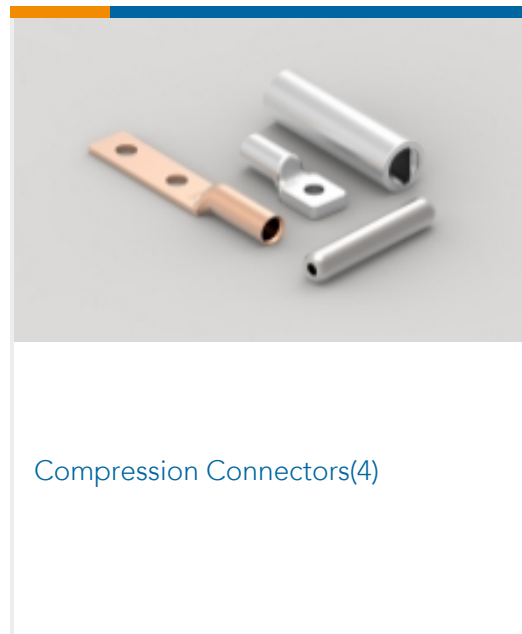

Customers Also Bought

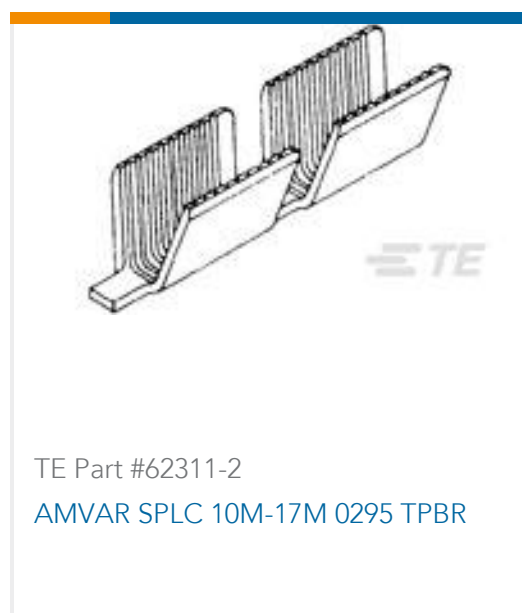



TE Part #1-292228-2
1.5 MINI CT SGL H SMT W/O BOSS



TE Part #1903614-1
0.50 CONNECTOR SYSTEM,
CONNECTOR HOUSING



TE Part #1903608-4
0.50 SERIES CONN 12POS PLUG
HOUSING ASSY

Documents

Product Drawings

[250 FASTON FLAG REC 18-12 AWG TPBZ](#)

English

CAD Files

Customer View Model

[ENG_CVM_CVM_41800_AP.2d_dxf.zip](#)

English

3D PDF

3D

Customer View Model

[ENG_CVM_CVM_41800_AP.3d_igs.zip](#)

English

Customer View Model

[ENG_CVM_CVM_41800_AP.3d_stp.zip](#)

English

By downloading the CAD file I accept and agree to the [Terms and Conditions](#) of use.

Datasheets & Catalog Pages

[82004 FASTON Terminals \(Insulated and Uninsulated\) Catalog - FASTON Receptacles Section](#)

English

[1654742_HOUSEHOLD_APPLIANCES_RAST5](#)

English

Product Specifications

[Engineering Report](#)

English

Agency Approvals

[Agency Approval Document](#)

English