

350699-3 ✓ ACTIVE

MATE-N-LOK | Universal MATE-N-LOK

TE Internal #: 350699-3

Pin Contact, Tin, 600 VAC, Locking Lance Contact Retention, 24 – 18 AWG Wire Size, .2 – .8 mm² Wire Size, Crimp, Phosphor Bronze, Universal MATE-N-LOK

[View on TE.com >](#)



Connectors > Contacts > Connector Contacts



Contact Type: **Pin**

Contact Mating Area Plating Material: **Tin**

Wire Contact Termination Area Plating Material: **Pre-Tin**

Operating Voltage: **600 VAC**

Contact Retention Within Housing: **With**

Features

Product Type Features

Discrete Wire Type	Stranded
--------------------	----------

Electrical Characteristics

Operating Voltage	600 VAC
-------------------	---------

Contact Features

Mating Pin Diameter	2.18 mm[.086 in]
Contact Shape & Form	Split
Contact Orientation	Straight
Contact Type	Pin
Contact Mating Area Plating Material	Tin
Wire Contact Termination Area Plating Material	Pre-Tin
Contact Retention Within Housing	With
Contact Base Material	Phosphor Bronze
Contact Current Rating (Max)	19 A

Termination Features



Termination Method to Wire & Cable	Crimp
------------------------------------	-------

Product Terminates To	Wire & Cable
-----------------------	--------------

Mechanical Attachment

Wire Insulation Support	Without
-------------------------	---------

Contact Retention Type Within Housing	Locking Lance
---------------------------------------	---------------

Dimensions

Compatible Insulation Diameter Range	1.02 – 2.54 mm [.04 – .1 in]
--------------------------------------	------------------------------

Wire Size	.2 – .8 mm ²
-----------	-------------------------

Usage Conditions

Operating Temperature Range	-55 – 105 °C [-67 – 221 °F]
-----------------------------	-----------------------------

Operation/Application

Circuit Application	Power
---------------------	-------

Industry Standards

Compatible With Agency/Standards Products	CSA, UL, VDE
---	--------------

Packaging Features

Packaging Quantity	7000
--------------------	------

Packaging Method	Reel
------------------	------

Product Compliance

[For compliance documentation, visit the product page on TE.com>](#)

EU RoHS Directive 2011/65/EU	Compliant
------------------------------	-----------

EU ELV Directive 2000/53/EC	Compliant
-----------------------------	-----------

China RoHS 2 Directive MIIT Order No 32, 2016	No Restricted Materials Above Threshold
---	---

EU REACH Regulation (EC) No. 1907/2006	Current ECHA Candidate List: JUNE 2024 (241) Candidate List Declared Against: JAN 2024 (240) Does not contain REACH SVHC
--	--

Halogen Content	Low Halogen - Br, Cl, F, I < 900 ppm per homogenous material. Also BFR/CFR/PVC Free
-----------------	---

Solder Process Capability	Not applicable for solder process capability
---------------------------	--

Product Compliance Disclaimer

This information is provided based on reasonable inquiry of our suppliers and represents our current actual knowledge based on the information they provided. This information is subject to change. The part numbers that TE has identified as EU RoHS compliant have a maximum concentration of 0.1% by weight in homogenous materials for lead, hexavalent chromium, mercury, PBB, PBDE, DBP, BBP, DEHP, DIBP, and 0.01% for cadmium, or qualify for an exemption to these limits as defined in the Annexes of Directive 2011/65/EU (RoHS2). Finished electrical and electronic equipment products will be CE marked as required by Directive 2011/65/EU. Components may not be CE marked. Additionally, the part numbers that TE has identified as EU ELV compliant have a maximum concentration of 0.1% by weight in homogenous materials for lead, hexavalent chromium, and mercury, and 0.01% for cadmium, or qualify for an exemption to these limits as defined in the Annexes of Directive 2000/53/EC (ELV). Regarding the REACH Regulation, the information TE provides on SVHC in articles for this part number is based on the latest European Chemicals Agency (ECHA) 'Guidance on requirements for substances in articles' posted at this URL: <https://echa.europa.eu/guidance-documents/guidance-on-reach>

Compatible Parts



TE Part # 2151019-1
OCEAN_2.0_Applicator-S-070F100F-RSM



TE Part # 91510-1
CCII UNML UNML II PIN SKT 24-18 ASSY

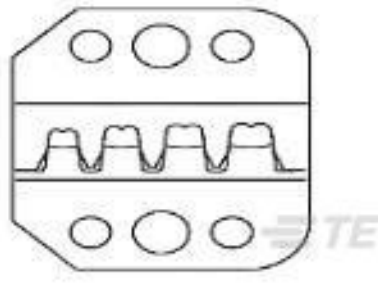

TE Part # 90548-2
PROCRIMPER DIE ASSY UNIV MNL



TE Part # 1804030-1
EXTRACTION TOOL ASSY



TE Part # 455830-1
INSERTION TOOL



TE Part # 1-480705-2
06P UNML CAP HSG RED



TE Part # 1-480708-9
12P UMNL PLUG HSG BLK



TE Part # 350784-1
15P UMNL CAP HSG



TE Part # 926307-3
6P UN-MNL AUFN-GEH



TE Part # 1-480704-2
06P UMNL PLUG HSG RED



TE Part # 926302-1
10& UNIV.M-N-L.PLUG



TE Part # 1-350777-2
02P UMNL V0 PLUG HSG RED



TE Part # 350783-1
12P UMNL CAP HSG



TE Part # 1-350778-9
02P UMNL V0 CAP HSG BLACK



TE Part # 350735-1
12P UMNL PLUG HSG



TE Part # 926302-3
10P UN-MNL STECKGEH



Also in the Series | Universal MATE-N-LOK

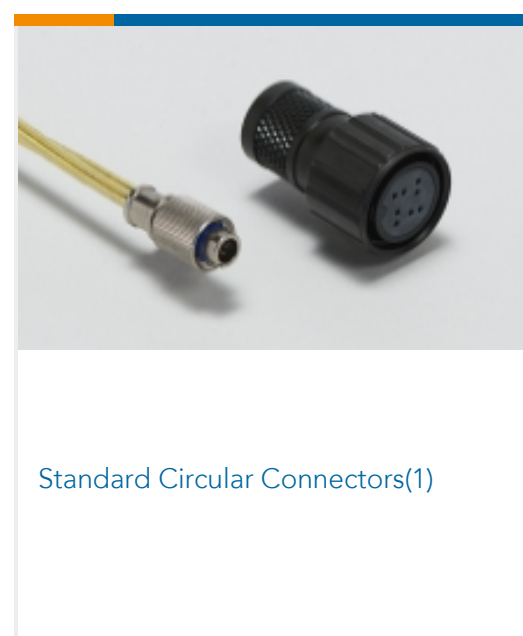
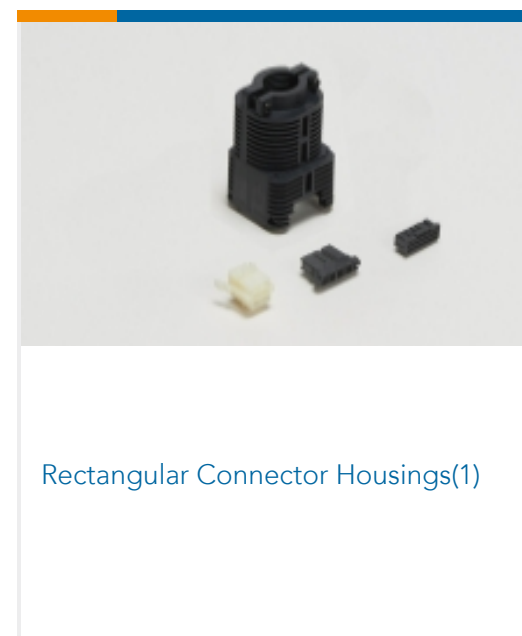
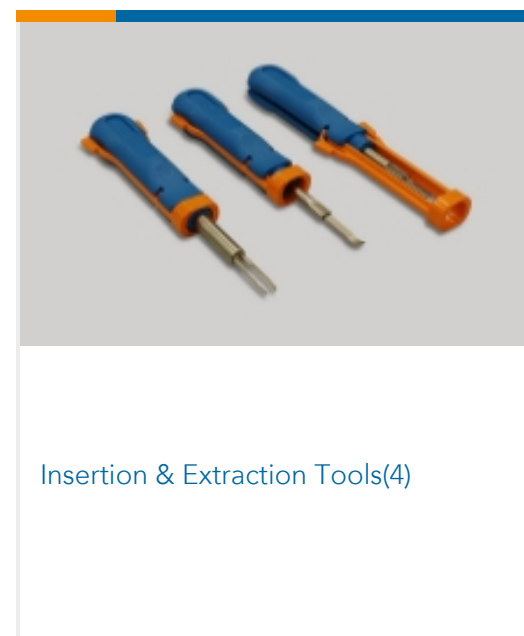
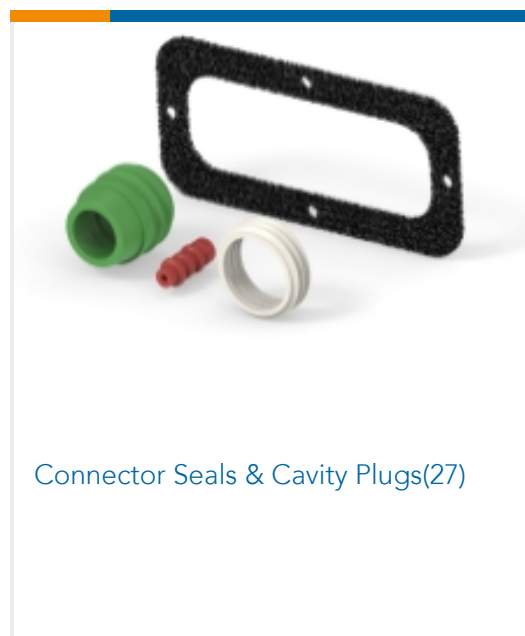
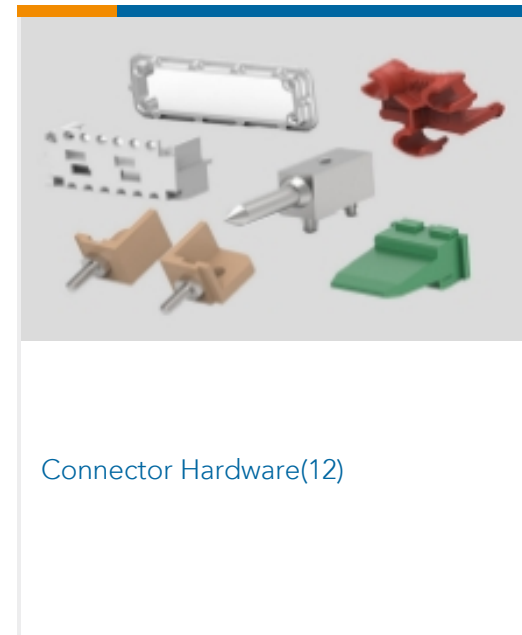
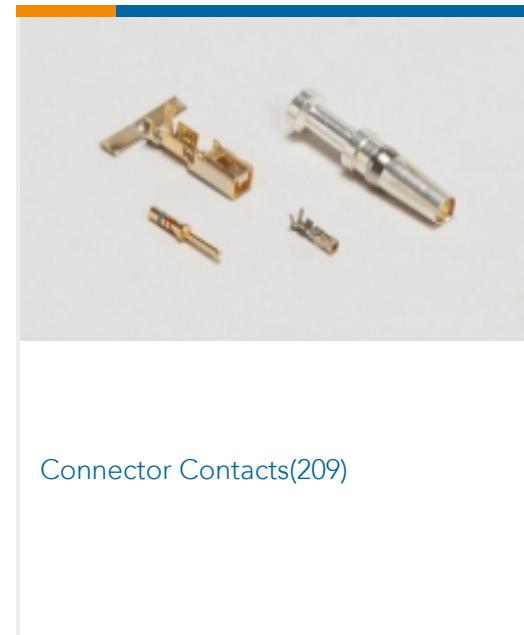
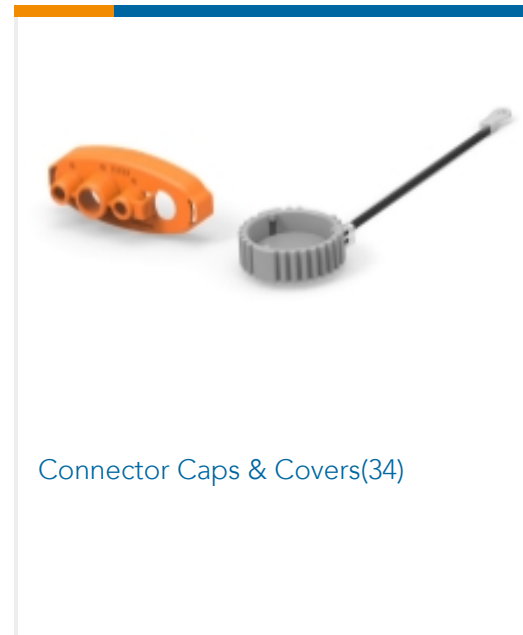
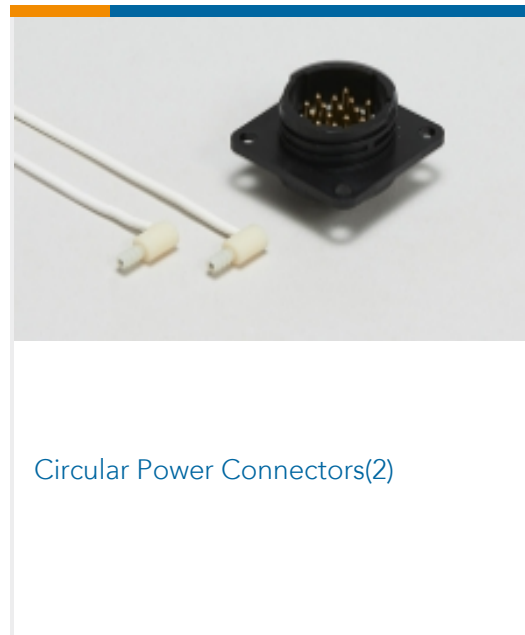

Customers Also Bought





Documents

Product Drawings

UMNL SPLIT PIN PTPPHBZ

English

CAD Files

3D PDF

3D

Customer View Model

[ENG_CVM_CVM_350699-3_BG.2d_dxf.zip](#)

English

Customer View Model

[ENG_CVM_CVM_350699-3_BG.3d_igs.zip](#)

English

Customer View Model

[ENG_CVM_CVM_350699-3_BG.3d_stp.zip](#)

English

By downloading the CAD file I accept and agree to the [Terms and Conditions](#) of use.

Datasheets & Catalog Pages

SOFT_SHELL_PIN_SOCKET_CONNECTORS_STANDARD_DENSITY

English

Product Specifications

Application Specification

English