

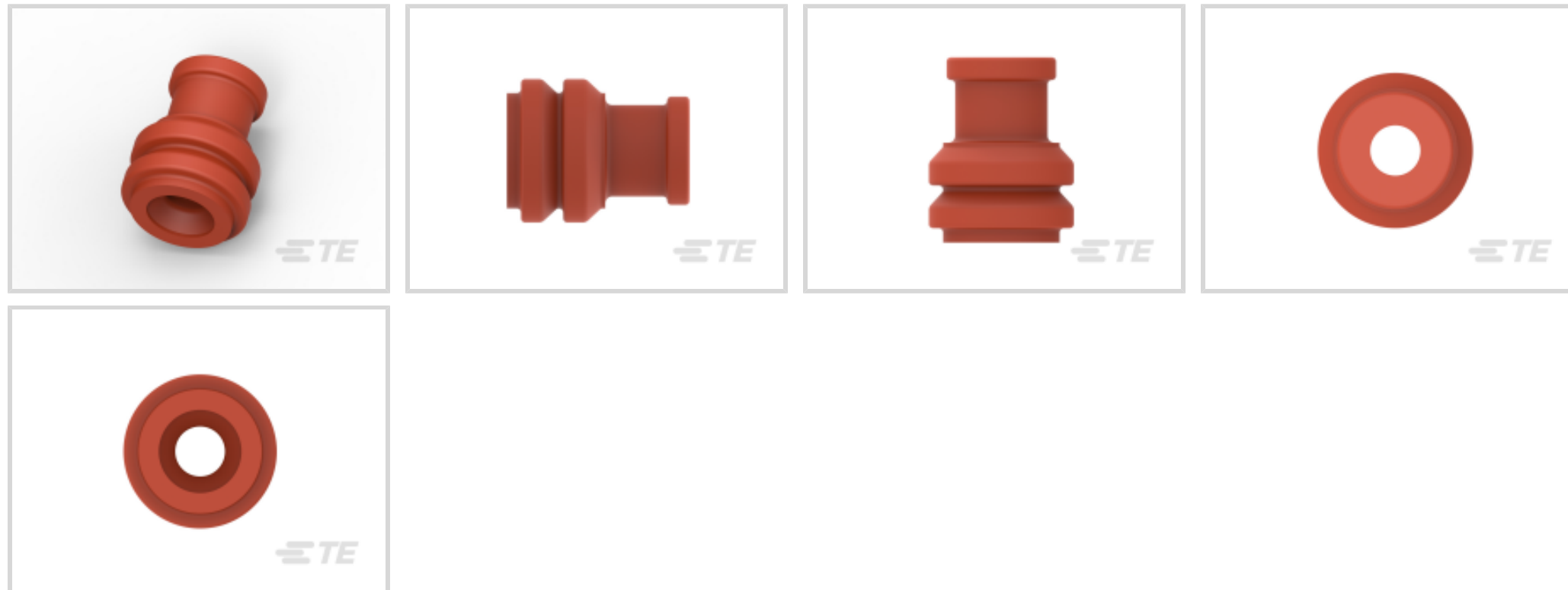

Connectors > Connector Accessories > Connector Seals & Cavity Plugs



Connector Seal & Plug Type: **Single Wire Seal (SWS)**

Primary Product Material: **Silicone**

Primary Product Color: **Brown**

Features

Product Type Features

| | |
|----------------------------|------------------------|
| Connector Seal & Plug Type | Single Wire Seal (SWS) |
|----------------------------|------------------------|

Body Features

| | |
|--------------------------|----------|
| Primary Product Material | Silicone |
| Primary Product Color | Brown |

Packaging Features

| | |
|--------------------|---------|
| Packaging Quantity | 50000 |
| Packaging Method | Package |

Product Compliance

[For compliance documentation, visit the product page on TE.com>](#)

| | |
|---|---|
| EU RoHS Directive 2011/65/EU | Compliant |
| EU ELV Directive 2000/53/EC | Compliant |
| China RoHS 2 Directive MIIT Order No 32, 2016 | No Restricted Materials Above Threshold |
| EU REACH Regulation (EC) No. 1907/2006 | Current ECHA Candidate List: JUNE 2024 (241) Candidate List Declared Against: JUNE 2024 (241) Does not contain REACH SVHC |

| | |
|---------------------------|---|
| Halogen Content | Low Halogen - Br, Cl, F, I < 900 ppm per homogenous material. Also BFR/CFR/PVC Free |
| Solder Process Capability | Not applicable for solder process capability |







Product Compliance Disclaimer

This information is provided based on reasonable inquiry of our suppliers and represents our current actual knowledge based on the information they provided. This information is subject to change. The part numbers that TE has identified as EU RoHS compliant have a maximum concentration of 0.1% by weight in homogenous materials for lead, hexavalent chromium, mercury, PBB, PBDE, DBP, BBP, DEHP, DIBP, and 0.01% for cadmium, or qualify for an exemption to these limits as defined in the Annexes of Directive 2011/65/EU (RoHS2). Finished electrical and electronic equipment products will be CE marked as required by Directive 2011/65/EU. Components may not be CE marked. Additionally, the part numbers that TE has identified as EU ELV compliant have a maximum concentration of 0.1% by weight in homogenous materials for lead, hexavalent chromium, and mercury, and 0.01% for cadmium, or qualify for an exemption to these limits as defined in the Annexes of Directive 2000/53/EC (ELV). Regarding the REACH Regulation, the information TE provides on SVHC in articles for this part number is based on the latest European Chemicals Agency (ECHA) 'Guidance on requirements for substances in articles' posted at this URL: <https://echa.europa.eu/guidance-documents/guidance-on-reach>

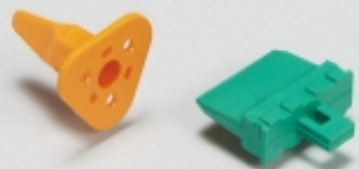
Compatible Parts

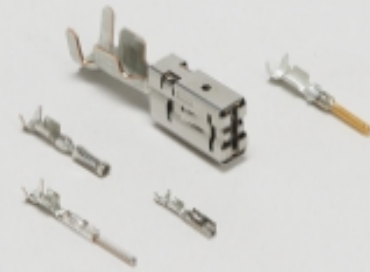
| | | | |
|--|--|---|---|
|  <p>TE Part # 1743632-2 HYB SLD 36P PLUG ASSY</p> |  <p>TE Part # 1-1719504-1 TAB 2.8x0.8 CONTACT CS SWS Sn</p> |  <p>TE Part # 2188967-3 SINGLE WIRE SEAL FOR 6.3MM</p> |  <p>TE Part # 1355881-3 MQS GRIFFSCHALE 6P</p> |
|--|--|---|---|

Also in the Series | Timer Connector System

| | | | |
|--|--|---|--|
|  <p>Automotive Connector Caps & Covers (14)</p> |  <p>Automotive Connector Locks & Position Assurance(15)</p> |  <p>Automotive Housings(215)</p> |  <p>Automotive Terminals(135)</p> |
|  <p>Connector Seals & Cavity Plugs(38)</p> |  <p>Crimp Terminal Housings(13)</p> |  <p>Insertion & Extraction Tools(18)</p> |  <p>Other Automotive Connector Accessories(1)</p> |

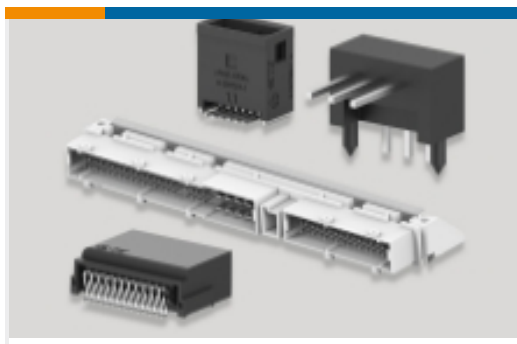

PCB Headers & Receptacles(40)



Quick Disconnects(4)

Customers Also Bought

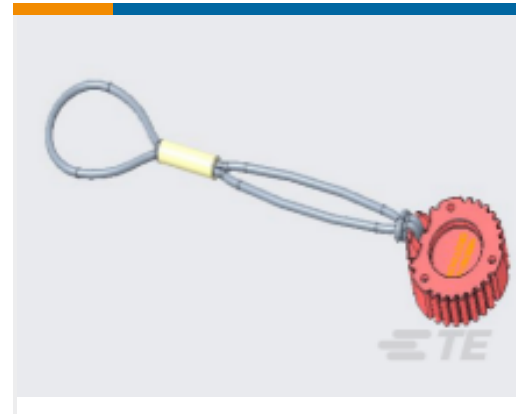
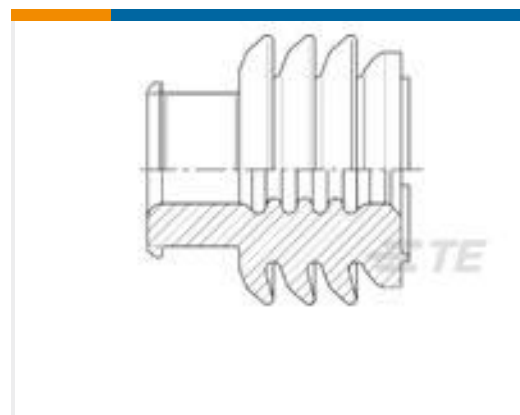
TE Part #DT06-6S-P012
PLG, 6P, BLK, N, SEAL RETTE Part #2-31811-5
TERMINAL, SOLIS R 4 1/4TE Part #HDC9-JDL082397
DUST CAP, 9P, REC, BLK, LANYARD,
HD10TE Part #2035366-8
AMPSEAL 16 Connectors Backshell
HD10TE Part #2098250-3
PIN, SF, SIZE 16, 16-18 AWG, NI/SNTE Part #1355437-1
MCP9,5 EINZELDICHTGTE Part #2-1564536-1
4POS,TAB5.8X0.8,TABHSG,ASSY,
COD. BTE Part #2-34125-6
TERMINAL,SOLIS R 16-14 5/16
COD. B

Documents

Product Drawings

[CABLE SEAL 12 AWG PWR TMR TERM](#)

English

CAD Files

[3D PDF](#)

3D

Customer View Model

[ENG_CVM_CVM_638865-1_A.2d_dxf.zip](#)

English

Customer View Model

[ENG_CVM_CVM_638865-1_A.3d_igs.zip](#)

English

Customer View Model

[ENG_CVM_CVM_638865-1_A.3d_stp.zip](#)

English

By downloading the CAD file I accept and agree to the [Terms and Conditions](#) of use.



[Product Specifications](#)

[Application Specification](#)

English