

320620 ✓ ACTIVE



PIDG

TE Internal #: 320620

Knife Disconnects, Tin, Wire Insulation Support, 12 – 10 AWG Wire Size, 2.62 – 6.64 mm² Wire Size, 5.17 – 13.1 kcmil Wire Size, Loose Piece, PIDG

[View on TE.com >](#)

Terminals & Splices > Knife Disconnects > PIDG Knife Disconnect Splices

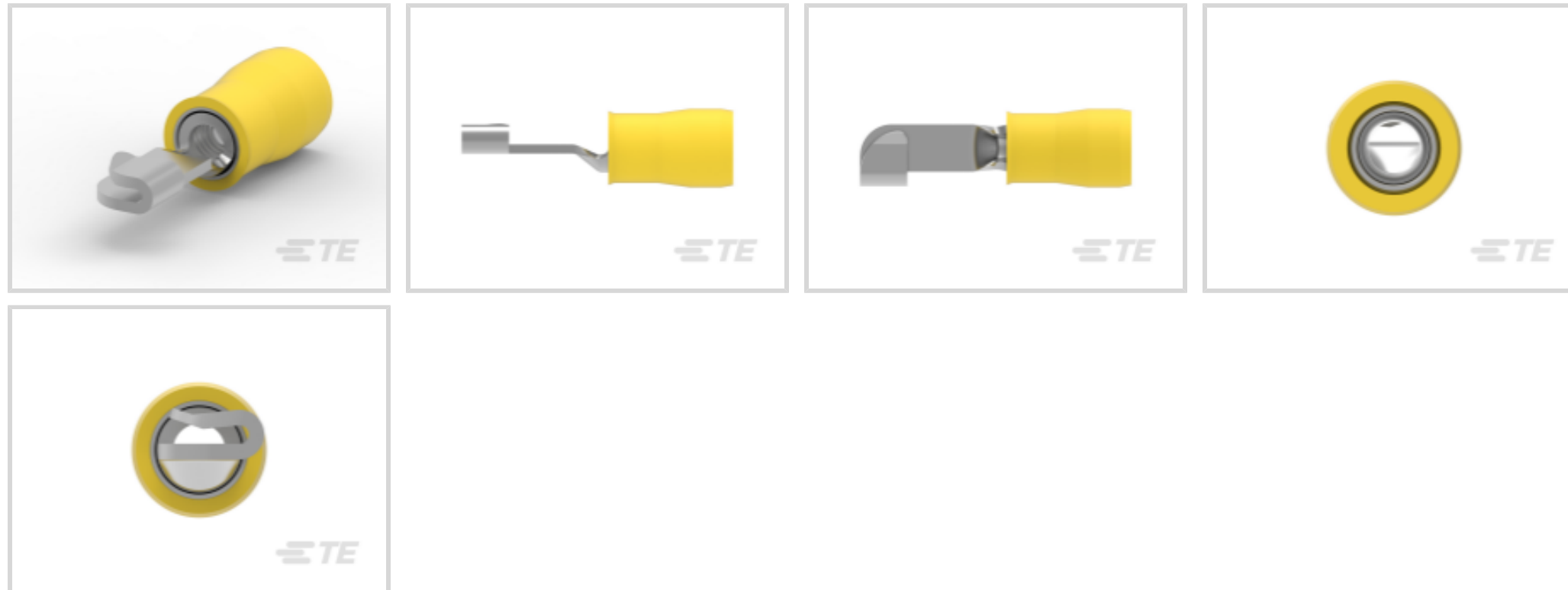

Body Plating Material: Tin

Wire Insulation Support: With

Compatible Insulation Diameter (Max): 5.84 mm [.23 in]

Wire Size: 2.62 – 6.64 mm²

[All PIDG Knife Disconnect Splices \(9\)](#)

Features

Body Features

Insulation Material	Nylon
Body Plating Material	Tin

Mechanical Attachment

Wire Insulation Support	With
-------------------------	------

Dimensions

Compatible Insulation Diameter (Max)	5.84 mm[.23 in]
Wire Size	5.17 – 13.1 kcmil

Usage Conditions

Insulation Option	Partially Insulated
Operating Temperature Range	105 °C[221 °F]

Packaging Features

Packaging Quantity	1
Packaging Method	Loose Piece

Other

Barrel Color	Yellow
--------------	--------

Product Compliance

[For compliance documentation, visit the product page on TE.com>](#)

EU RoHS Directive 2011/65/EU	Compliant
EU ELV Directive 2000/53/EC	Compliant
China RoHS 2 Directive MIIT Order No 32, 2016	No Restricted Materials Above Threshold
EU REACH Regulation (EC) No. 1907/2006	Current ECHA Candidate List: JUNE 2024 (241) Candidate List Declared Against: JAN 2024 (240) Does not contain REACH SVHC
Halogen Content	Low Halogen - Br, Cl, F, I < 900 ppm per homogenous material. Also BFR/CFR/PVC Free
Solder Process Capability	Not applicable for solder process capability

Product Compliance Disclaimer

This information is provided based on reasonable inquiry of our suppliers and represents our current actual knowledge based on the information they provided. This information is subject to change. The part numbers that TE has identified as EU RoHS compliant have a maximum concentration of 0.1% by weight in homogenous materials for lead, hexavalent chromium, mercury, PBB, PBDE, DBP, BBP, DEHP, DIBP, and 0.01% for cadmium, or qualify for an exemption to these limits as defined in the Annexes of Directive 2011/65/EU (RoHS2). Finished electrical and electronic equipment products will be CE marked as required by Directive 2011/65/EU. Components may not be CE marked. Additionally, the part numbers that TE has identified as EU ELV compliant have a maximum concentration of 0.1% by weight in homogenous materials for lead, hexavalent chromium, and mercury, and 0.01% for cadmium, or qualify for an exemption to these limits as defined in the Annexes of Directive 2000/53/EC (ELV). Regarding the REACH Regulation, the information TE provides on SVHC in articles for this part number is based on the latest European Chemicals Agency (ECHA) 'Guidance on requirements for substances in articles' posted at this URL: <https://echa.europa.eu/guidance-documents/guidance-on-reach>

Compatible Parts

 <p>TE Part # 58433-3 PRO CR ASSY, RBY IS9252</p>	 <p>TE Part # 58423-1 DIE, RBY IS9252</p>	 <p>TE Part # 679300-1 1210 PIDG CRIMP HEAD</p>	 <p>TE Part # 59824-1 TETRA-CRIMP PIDG PG FASTON 22-10 ASSY</p>
--	--	--	--



TE Part # 59239-4
HHHT PIDG PG 12-10 ASSY



TE Part # 539691-2
ERGO DIE R.B.Y



TE Part # 2063030-1
SDE DIESET, RBY, UL



TE Part # 47808-6
DIES PIDG 12-10 DIE SET



TE Part # 169400
CERTI-LOK FRAME W/O DIES



TE Part # 169404
CERTI-LOK DIE



TE Part # 1SET191001R0000
CRIMP-HT



TE Part # 1SET191002R0000
TET CRIMP-HT

Also in the Series | PIDG

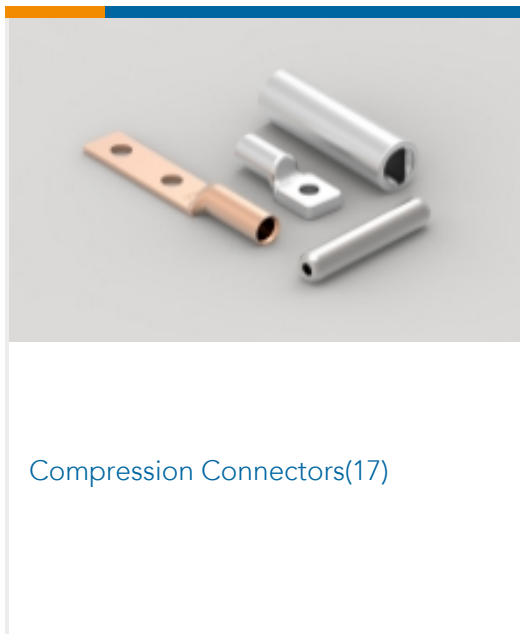

Compression Connectors(17)



Crimp Wire Pins, Tabs & Ferrules(41)

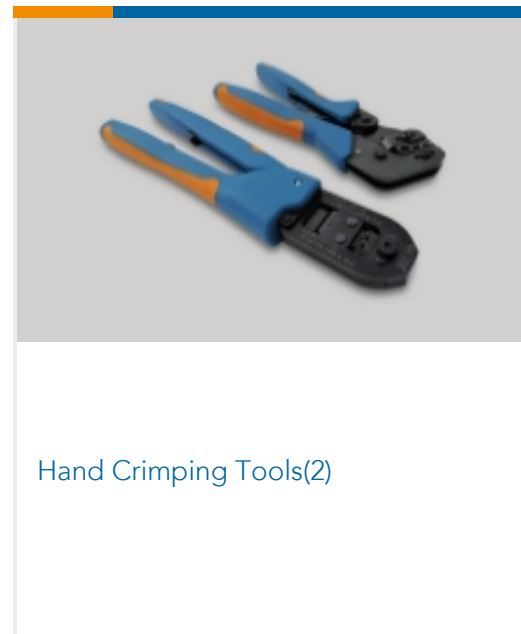

Hand Crimping Tools(2)

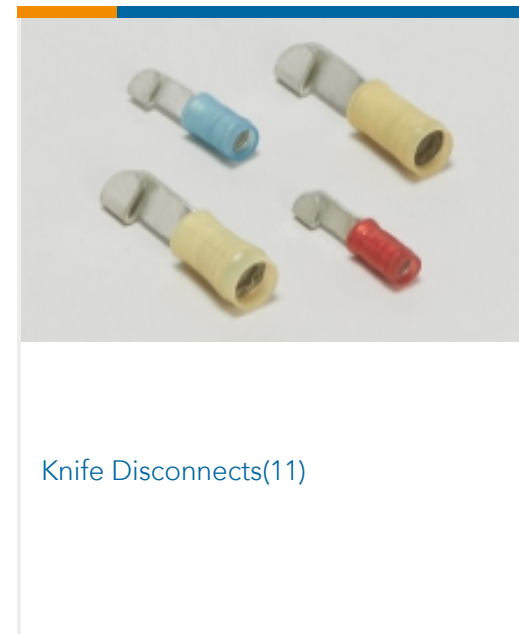

Knife Disconnects(11)

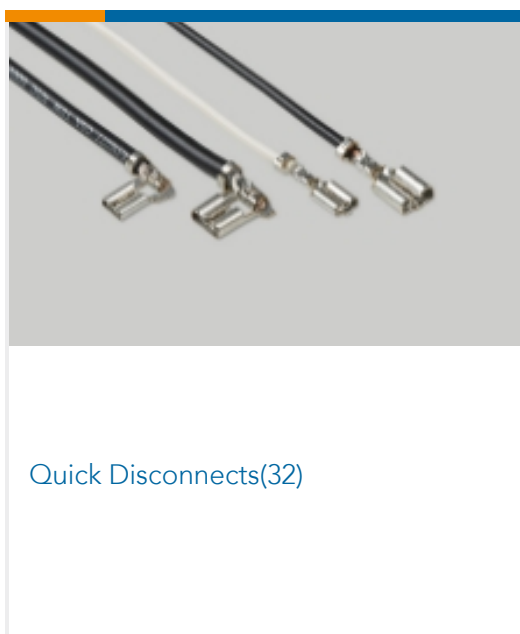

Quick Disconnects(32)

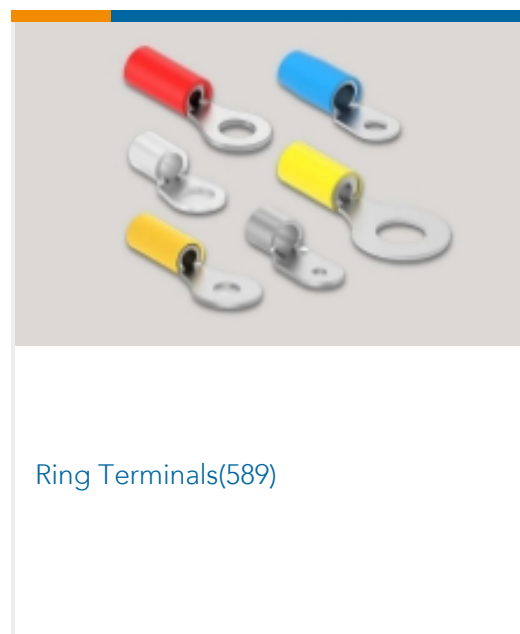

Ring Terminals(589)

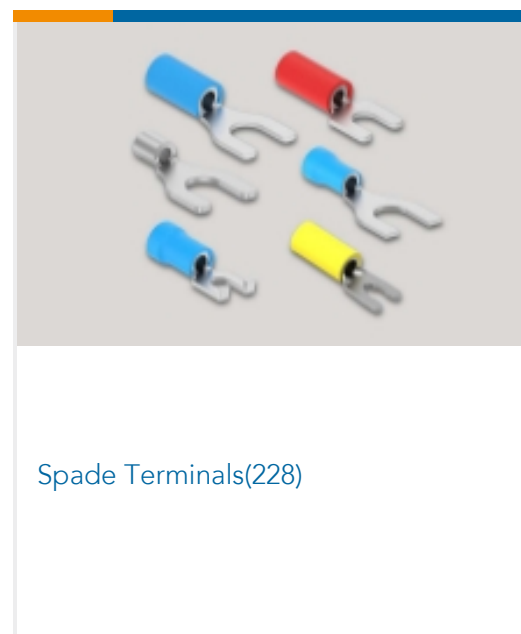

Spade Terminals(228)

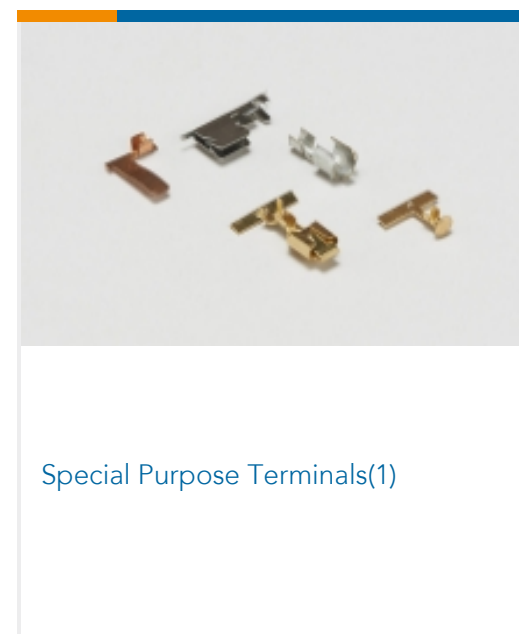

Special Purpose Terminals(1)



Splices(40)

Customers Also Bought

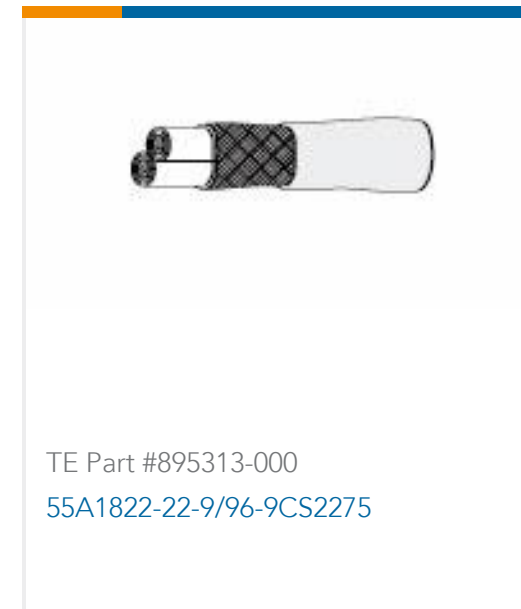
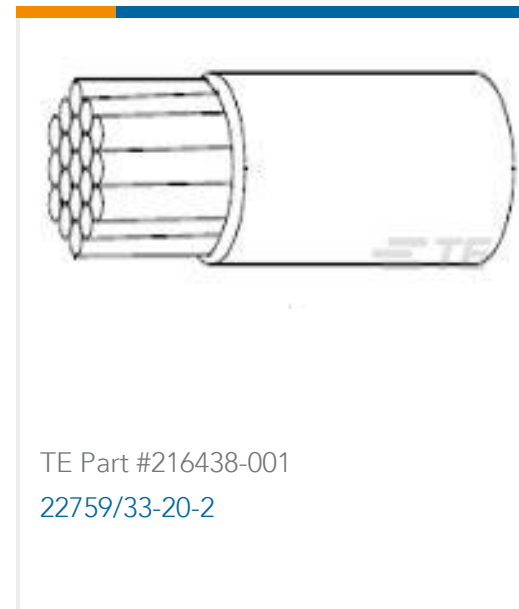
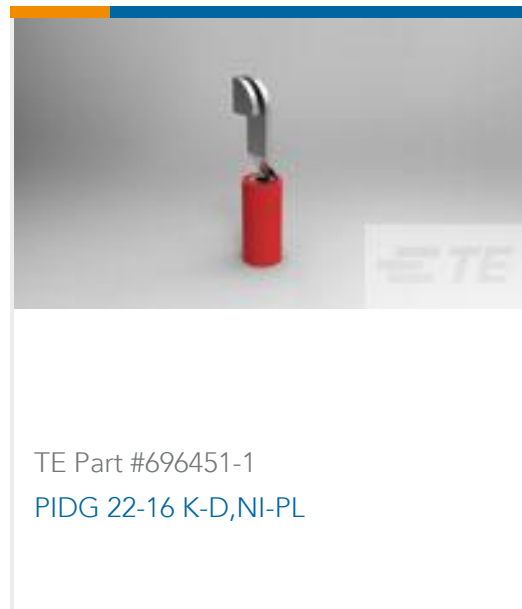

Documents

Product Drawings

[KNIFE DISCONNECT,N PIDG 12-10](#)

English

CAD Files

[3D PDF](#)

3D

Customer View Model

[ENG_CVM_CVM_320620_E.2d_dxf.zip](#)

English

Customer View Model

[ENG_CVM_CVM_320620_E.3d_igs.zip](#)

English

Customer View Model

[ENG_CVM_CVM_320620_E.3d_stp.zip](#)

English

By downloading the CAD file I accept and agree to the [Terms and Conditions](#) of use.

Instruction Sheets

[Instruction Sheet \(U.S.\)](#)

English

Agency Approvals

[Agency Approval Document](#)

English