

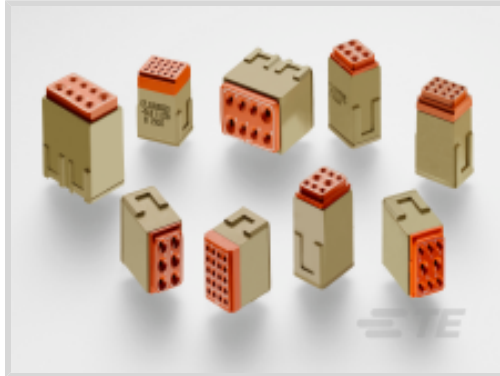

Connectors > Terminal Junction Modules & Accessories > Terminal Junction Modules



Terminal Junction System Component Type: **Feedback Module**

Compatible With Contact Size: **22**

Operating Temperature Range: **-65 – 200 °C**

Features

Product Type Features

Terminal Junction System Component Type	Feedback Module
---	-----------------

Body Features

Connector Seal Material	Elastomer
-------------------------	-----------

Contact Features

Compatible With Contact Size	22
------------------------------	----

Usage Conditions

Operating Temperature Range	-65 – 200 °C
-----------------------------	--------------

Product Compliance

[For compliance documentation, visit the product page on TE.com>](#)

EU RoHS Directive 2011/65/EU	Compliant
EU ELV Directive 2000/53/EC	Compliant
China RoHS 2 Directive MIIT Order No 32, 2016	No Restricted Materials Above Threshold
EU REACH Regulation (EC) No. 1907/2006	Current ECHA Candidate List: JUNE 2024 (241) Candidate List Declared Against: JUNE 2022 (224) Does not contain REACH SVHC
Halogen Content	Not Yet Reviewed for halogen content
Solder Process Capability	Not reviewed for solder process capability

Product Compliance Disclaimer

This information is provided based on reasonable inquiry of our suppliers and represents our current actual knowledge based on the information they provided. This information is subject to change. The part numbers that TE has identified as EU RoHS compliant have a maximum concentration of 0.1% by weight in homogenous materials for lead, hexavalent chromium, mercury, PBB, PBDE, DBP, BBP, DEHP, DIBP, and 0.01% for cadmium, or qualify for an exemption to these limits as defined in the Annexes of Directive 2011/65/EU (RoHS2). Finished electrical and electronic equipment products will be CE marked as required by Directive 2011/65/EU. Components may not be CE marked. Additionally, the part numbers that TE has identified as EU ELV compliant have a maximum concentration of 0.1% by weight in homogenous materials for lead, hexavalent chromium, and mercury, and 0.01% for cadmium, or qualify for an exemption to these limits as defined in the Annexes of Directive 2000/53/EC (ELV). Regarding the REACH Regulation, the information TE provides on SVHC in articles for this part number is based on the latest European Chemicals Agency (ECHA) 'Guidance on requirements for substances in articles' posted at this URL: <https://echa.europa.eu/guidance-documents/guidance-on-reach>

Also in the Series | **DEUTSCH CTJ**

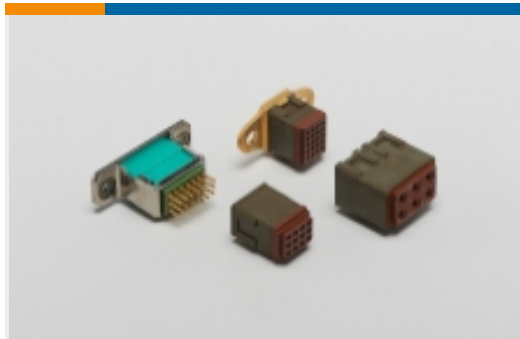

Terminal Junction Modules(96)

Customers Also Bought



TE Part #D369-P66-NS1
369 6 WAY PLUG, CRIMP, SKT



TE Part #ABC03N-22P-4048
IN-LINE RECP

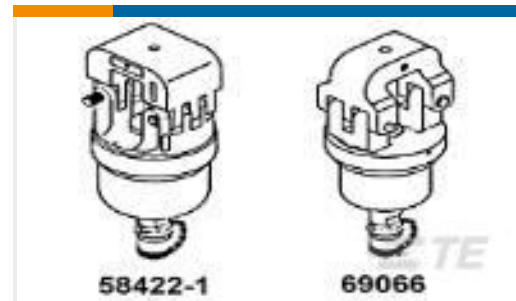

TE Part #58422-1
HYP8 8-4/0AWG 33T HEAD



TE Part #DCR-1A-02
COMPOSIT RAIL

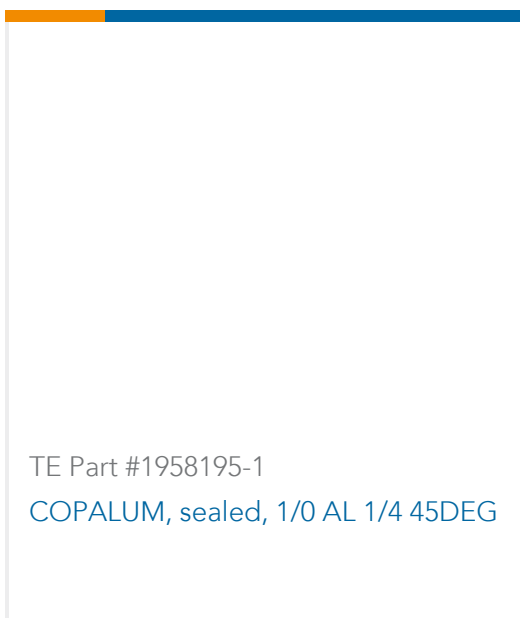

TE Part #1958195-1
COPALUM, sealed, 1/0 AL 1/4 45DEG

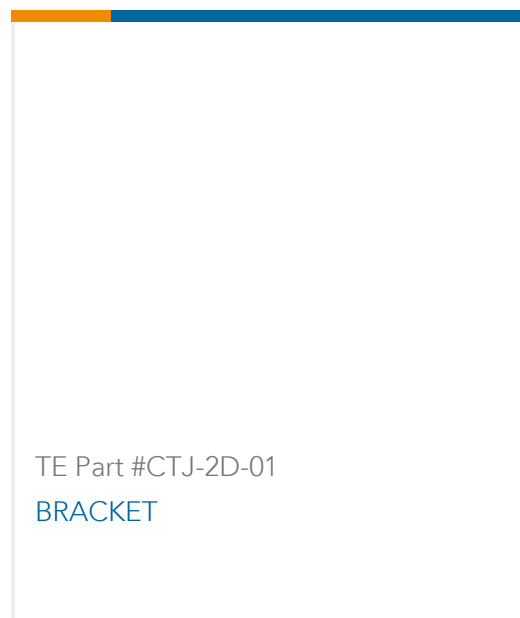

TE Part #CTJ-2D-01
BRACKET



TE Part #656952-000
NPVF050OE-100

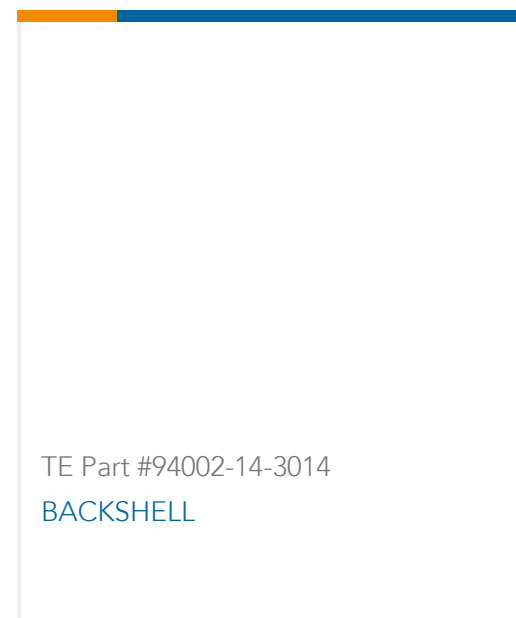

TE Part #94002-14-3014
BACKSHELL

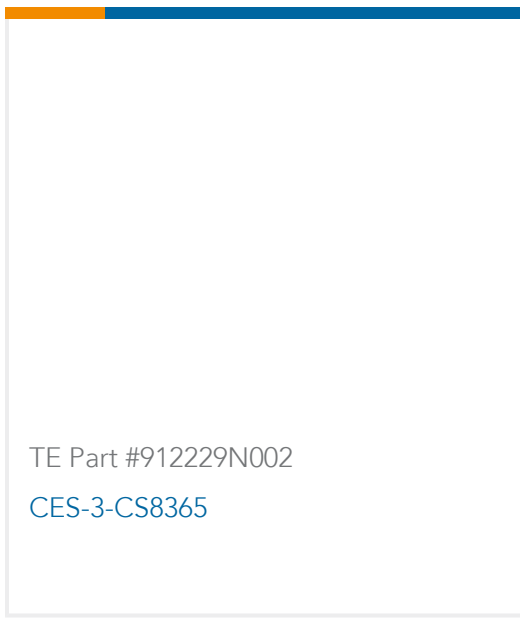

Documents

Product Drawings

[MODULE ASSY](#)

English

CAD Files

[3D PDF](#)

3D

Customer View Model

[ENG_CVM_CVM_CTJ122E02D-513_99.2d_dxf.zip](#)

English

Customer View Model

[ENG_CVM_CVM_CTJ122E02D-513_99.3d_igs.zip](#)

English

Customer View Model

[ENG_CVM_CVM_CTJ122E02D-513_99.3d_stp.zip](#)

English

By downloading the CAD file I accept and agree to the [Terms and Conditions](#) of use.