

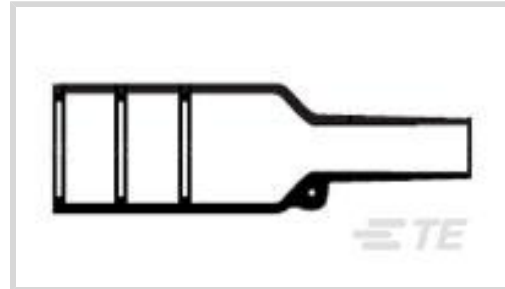

Wire Protection & Management > Heat Shrink Shapes > Heat Shrink Boots > Bulbous Heat Shrink Boots: Lipped, Straight



Body Orientation: **Straight**

Molded Part Shape Code: **202**

Lipped: **Yes**

Material Code: **3**

Material Systems Code: **10**

[All Bulbous Heat Shrink Boots: Lipped, Straight \(364\)](#)

Features

Configuration Features

Lipped	Yes
Adhesive Requirement	Adhesive Purchased Separately

Body Features

Primary Product Material	Semi-Rigid Modified Polyolefin
Material Code	3
Material Systems Code	10

Housing Features

Body Orientation	Straight
------------------	----------

Dimensions

Compatible Cable Diameter (Max)	7 mm, 8 mm, 9 mm, 10 mm, 11 mm, 12 mm [.27 in][.314 in][.35 in][.39 in][.43 in][.47 in]
Compatible Cable Diameter Range	5.9 – 14 mm[5.9 – 15 in]

Usage Conditions

Operating Temperature Range	-55 – 135 °C[-67 – 275 °F]
Resistance Protection	Occasional Fluid Exposure

Industry Standards

--	--

Compatible With Approved Standards Products

BS-G-198-5-DA, DEF Std 59-97 Issue 3
Type DA, SAE AS I 81765/1, Type I, UL 224,
File E85381

Other

Molded Part Shape Code

202

Product Compliance

For compliance documentation, visit the product page on [TE.com](https://www.te.com)>

EU RoHS Directive 2011/65/EU

Compliant

EU ELV Directive 2000/53/EC

Compliant

China RoHS 2 Directive MIIT Order No 32, 2016

No Restricted Materials Above Threshold

EU REACH Regulation (EC) No. 1907/2006

Current ECHA Candidate List: JUNE 2024
(241)
Candidate List Declared Against: JAN 2024
(240)
Does not contain REACH SVHC

Halogen Content

Out of Scope - excluded from Halogen
requirements

Solder Process Capability

Not applicable for solder process capability

Product Compliance Disclaimer

This information is provided based on reasonable inquiry of our suppliers and represents our current actual knowledge based on the information they provided. This information is subject to change. The part numbers that TE has identified as EU RoHS compliant have a maximum concentration of 0.1% by weight in homogenous materials for lead, hexavalent chromium, mercury, PBB, PBDE, DBP, BBP, DEHP, DIBP, and 0.01% for cadmium, or qualify for an exemption to these limits as defined in the Annexes of Directive 2011/65/EU (RoHS2). Finished electrical and electronic equipment products will be CE marked as required by Directive 2011/65/EU. Components may not be CE marked. Additionally, the part numbers that TE has identified as EU ELV compliant have a maximum concentration of 0.1% by weight in homogenous materials for lead, hexavalent chromium, and mercury, and 0.01% for cadmium, or qualify for an exemption to these limits as defined in the Annexes of Directive 2000/53/EC (ELV). Regarding the REACH Regulation, the information TE provides on SVHC in articles for this part number is based on the latest European Chemicals Agency (ECHA) 'Guidance on requirements for substances in articles' posted at this URL: <https://echa.europa.eu/guidance-documents/guidance-on-reach>

Compatible Parts

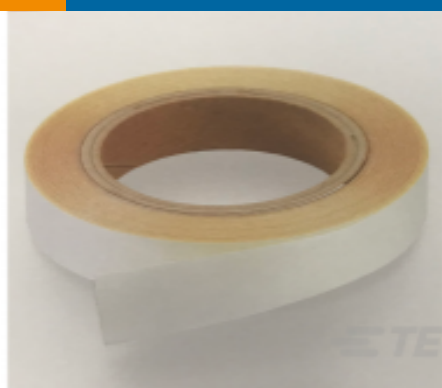

TE Part # 890060-000
[S1017-1.0X50](#)

Customers Also Bought



TE Part #812846-000
Bulbous Heat Shrink Boots: Lipped,
Right Angle

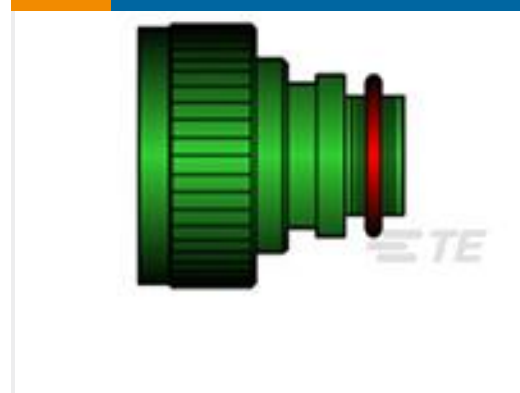

TE Part #415115-000
TXR40AB00-0804BI



TE Part #C538733001
RAY-101-12.5(100)

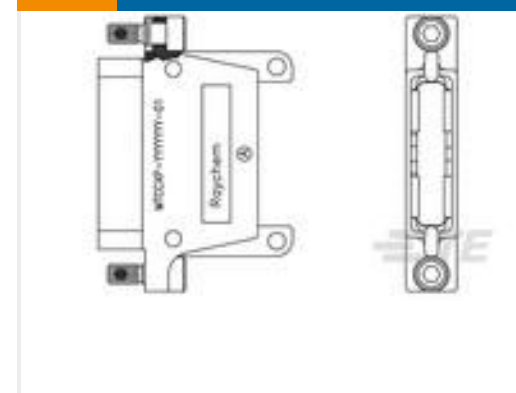

TE Part #364283-000
MTCC1P-010-010-01

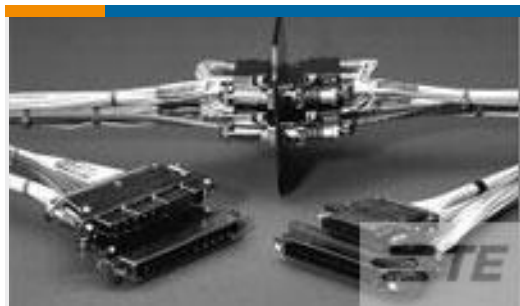

TE Part #699693-000
MTC100-JH1-P22

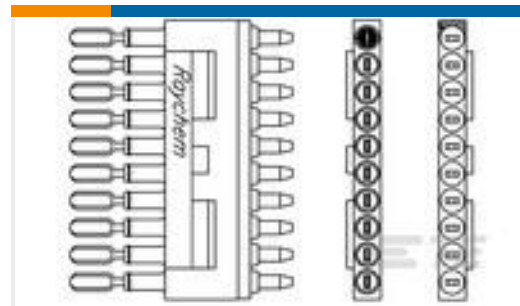

TE Part #699214-000
MTCB2X-206-XXX

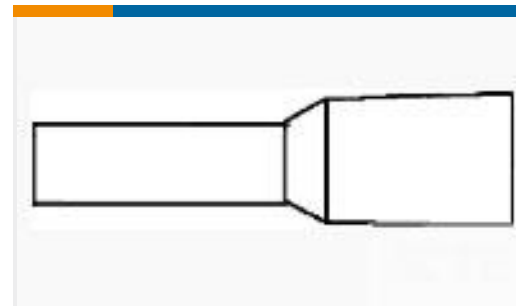

TE Part #1-966066-9
FER,WIRE,PL SLV,.75/18,L6,WHITE,LP

Documents

Product Drawings

[202K132-3-0](#)

English

Datasheets & Catalog Pages

[1654025_Sec4_-3](#)

English

Raychem Molded Parts Visual Guide

English

Product Specifications

[Product Specification](#)

English