

SF51G THRU SF58G

List

List..... 1

Package outline..... 2

Features..... 2

Mechanical data..... 2

Maximum ratings2

Rating and characteristic curves..... 3

Pinning information.....4

Marking..... 4

Taping & bulk specifications for AXIAL devices..... 4

Suggested thermal profiles for soldering processes..... 5

High reliability test capabilities.....6

SF51G THRU SF58G

5.0A Axial Leaded Super Fast Rectifiers-50-600V

Features

- Low reverse leakage current
- Low forward drop down voltage & high current capability
- High surge current capability
- Super fast switching speed for high efficiency
- Glass passivated chip junction
- High Reliability
- Lead-free parts for green partner, meet RoHS requirements
- Suffix "-H" indicates Halgon free parts, ex. SF51G-H.

Mechanical data

- Epoxy : UL94-V0 rated flame retardant
- Case : Molded plastic, DO-201AD
- Lead : Axial leads, solderable per MIL-STD-202, Method 208 guaranteed
- Polarity: Color band denotes cathode end
- Mounting Position : Any
- Weight : Approximated 1.10 gram

Package outline

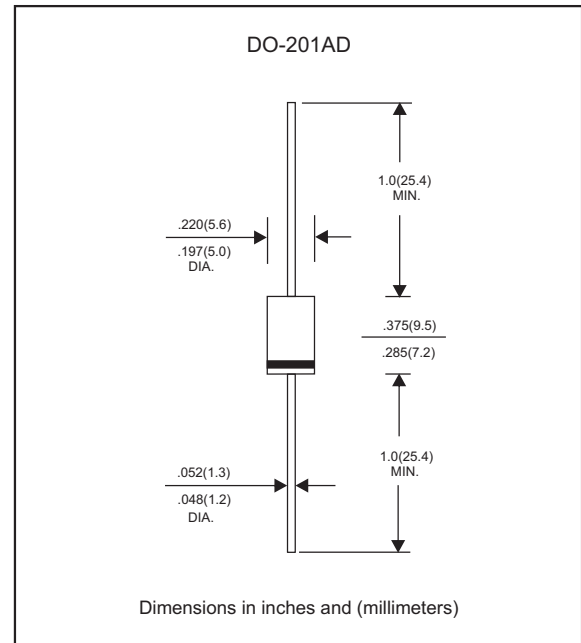

Maximum ratings and Electrical Characteristics (AT T_A=25°C unless otherwise noted)

PARAMETER	CONDITIONS	Symbol	MIN.	TYP.	MAX.	UNIT
Forward rectified current	Ambient temperature = 55°C	I _O			5.0	A
Forward surge current	8.3ms single half sine-wave (JEDEC methode)	I _{FSM}			150	A
Reverse current	V _R = V _{RRM} T _J = 25°C	I _R			5.0	μA
	V _R = V _{RRM} T _J = 125°C				100	
Thermal resistance	Junction to ambient	R _{θJA}		30		°C/W
Diode junction capacitance	f=1MHz and applied 4V DC reverse voltage	C _J		80		pF
Storage temperature		T _{STG}	-65		+175	°C

SYMBOLS	V _{RRM} ^{*1} (V)	V _{RMS} ^{*2} (V)	V _R ^{*3} (V)	V _F ^{*4} (V)	t _{tr} ^{*5} (ns)	Operating temperature T _J , (°C)
SF51G	50	35	50	0.95	35	-55 to +150
SF52G	100	70	100			
SF53G	150	105	150			
SF54G	200	140	200			
SF55G	300	210	300	1.25	35	-55 to +150
SF56G	400	280	400			
SF57G	500	350	500			
SF58G	600	420	600	1.70	35	-55 to +150

- *1 Repetitive peak reverse voltage
- *2 RMS voltage
- *3 Continuous reverse voltage
- *4 Maximum forward voltage@I_F=5.0A
- *5 Maximum Reverse recovery time, note 1

Note 1. Reverse recovery time test condition, I_F=0.5A, I_R=1.0A, I_{RR}=0.25A

Rating and characteristic curves (SF51G THRU SF58G)

FIG.1- TEST CIRCUIT DIAGRAM AND REVERSE RECOVERY TIME CHARACTERISTIC

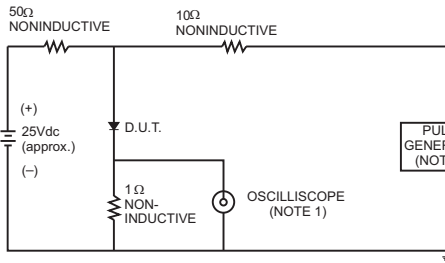

NOTES: 1. Rise Time= 7ns max., Input Impedance= 1 megohm.22pF.
2. Rise Time= 10ns max., Source Impedance= 50 ohms.

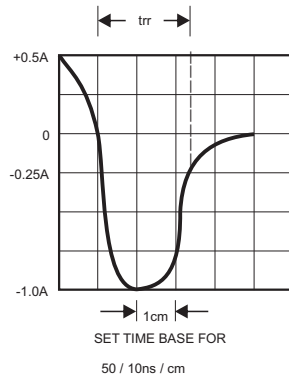

FIG.2-TYPICAL FORWARD CURRENT DERATING CURVE

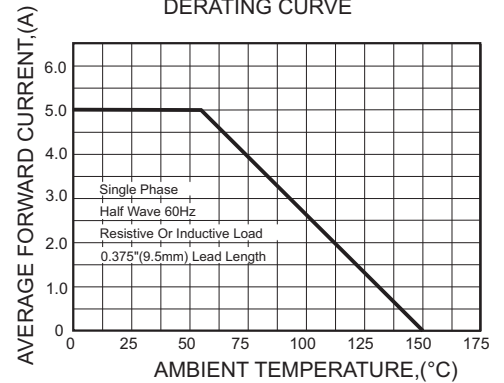

FIG. 3 - TYPICAL FORWARD CHARACTERISTICS

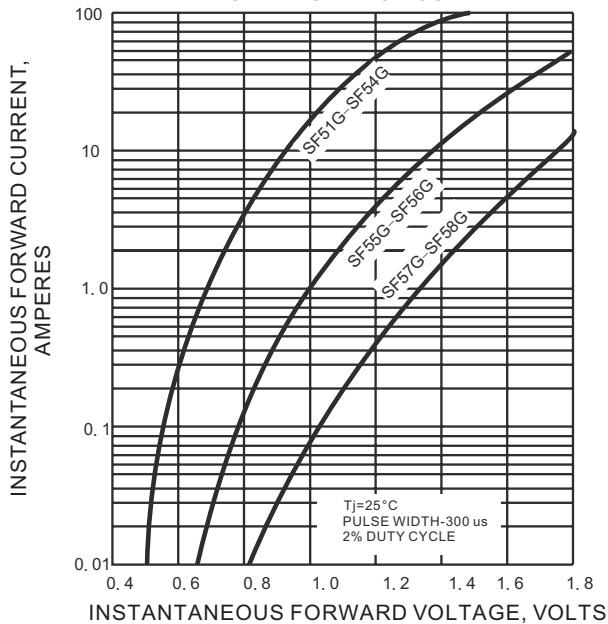

FIG.4-TYPICAL REVERSE CHARACTERISTICS

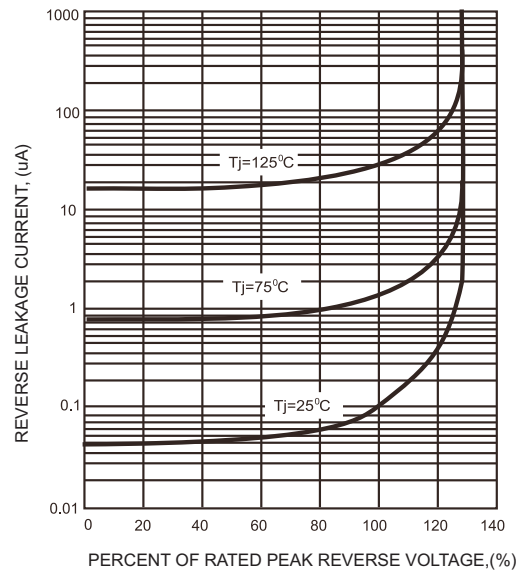

FIG.5-MAXIMUM NON-REPETITIVE FORWARD SURGE CURRENT

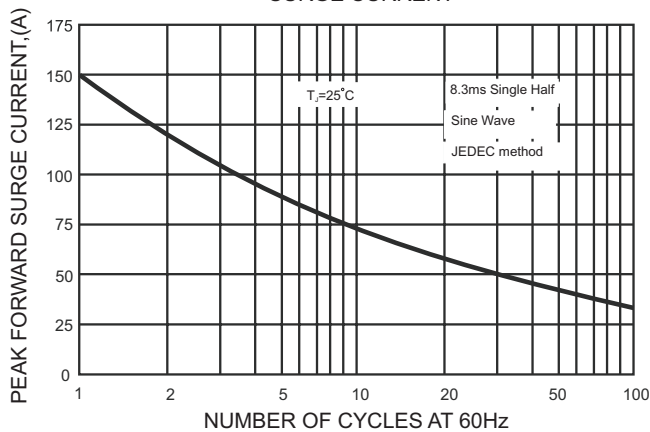
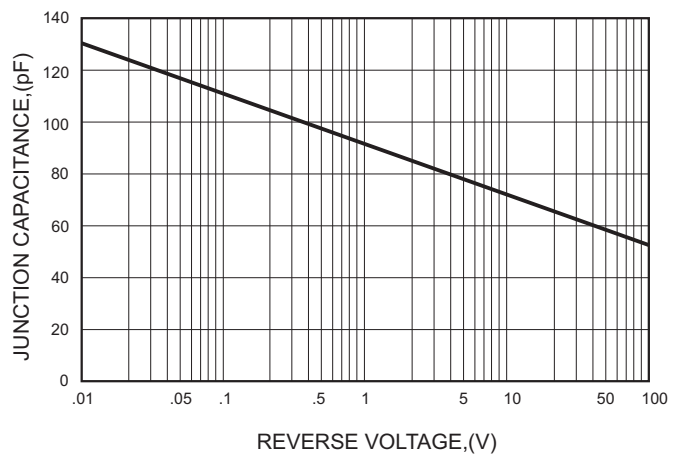



FIG.6-TYPICAL JUNCTION CAPACITANCE



SF51G THRU SF58G

Pinning information

Pin	Simplified outline	Symbol
Pin1 cathode Pin2 anode		

Marking

Type number	Marking code
SF51G	SF51G
SF52G	SF52G
SF53G	SF53G
SF54G	SF54G
SF55G	SF55G
SF56G	SF56G
SF57G	SF57G
SF58G	SF58G

Taping & bulk specifications for AXIAL devices

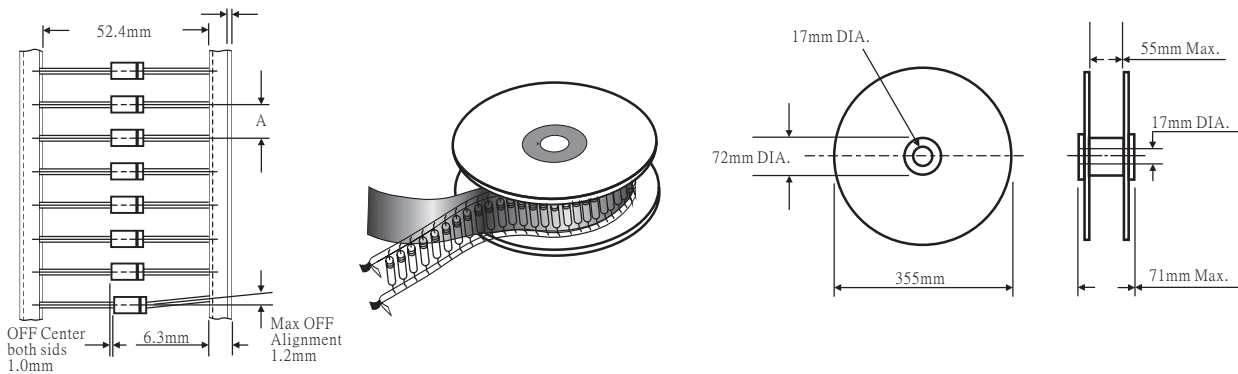

REEL PACKING

DEVICE CASE TYPE	Q'TY 1 (PCS / REEL)	COMPONENT SPACING "A" in FIG. A	CARTON SIZE (m/m)	Q'TY 2 (PCS / CARTON)	APPROX. CROSS WEIGHT(kg)
DO-201AD	1,200	10 mm	380 * 340 * 370	4,800	9.1

AMMO PACKING

DEVICE CASE TYPE	Q'TY 1 (PCS / BOX)	INNER BOX SIZE (m/m)	CARTON SIZE (m/m)	Q'TY 2 (PCS / CARTON)	APPROX. CROSS WEIGHT(kg)
DO-201AD	1,200	260 * 83 * 160	440 * 270 * 340	12,000	17.0

SF51G THRU SF58G

BULK PACKING

DEVICE CASE TYPE	Q'TY 1 (PCS / BOX)	INNER BOX SIZE (m/m)	CARTON SIZE (m/m)	Q'TY 2 (PCS / CARTON)	APPROX. CROSS WEIGHT(kg)
DO-201AD	500	305 * 73 * 40	347 * 320 * 271	12,000	16.4

Suggested thermal profiles for soldering processes

1. Lead free temperature profile wave-soldering

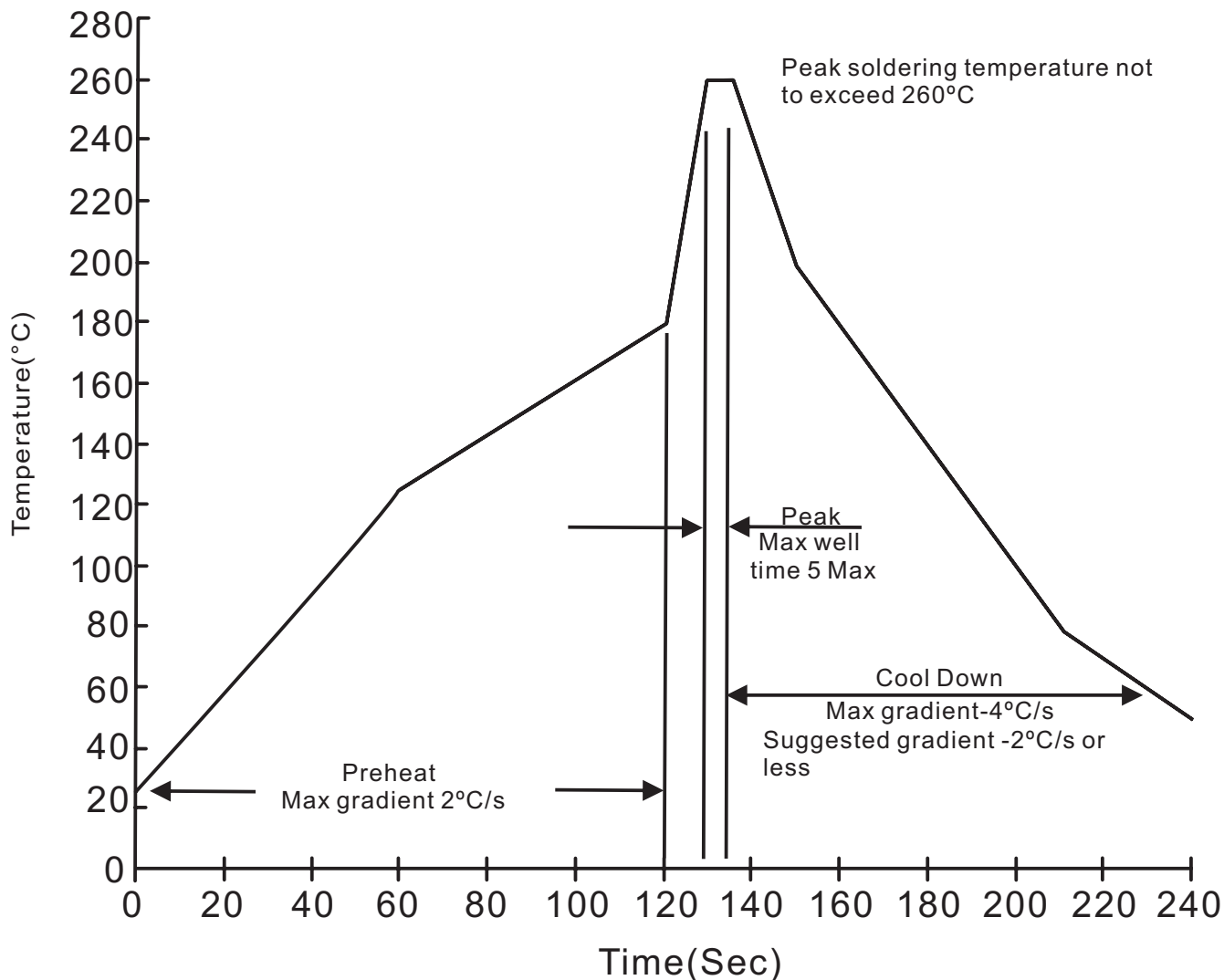

SF51G THRU SF58G**High reliability test capabilities**

Item Test	Conditions	Reference
1. Solder Resistance	at 260±5°C for 10±2sec. immerse body into solder 1/16"±1/32"	MIL-STD-750D METHOD-2031
2. Solderability	at 245±5°C for 5 sec.	MIL-STD-202F METHOD-208
3. Pull Test	2.0kg in axial lead direction for 10 sec. $I_F = I_O$	MIL-STD-202F METHOD-211A
4. Bend Lead	2.0kg weight applied to each lead bending arc 90°±5° for 3 times	MIL-STD-202F METHOD-211A
5. High Temperature Reverse Bias	$V_R = 80\%$ rate at $T_J = 150^\circ\text{C}$ for 168 hrs.	MIL-STD-750D METHOD-1038
6. Forward Operation Life	Rated average rectifier current at $T_A = 25^\circ\text{C}$ for 500hrs. $T_A = 25^\circ\text{C}$, $I_F = I_O$	MIL-STD-750D METHOD-1027
7. Intermittent Operation Life	On state: power on for 5 min. off state: power off for 5 min, on and off for 500 cycles.	MIL-STD-750D METHOD-1036
8. Pressure Cooker	15P _{sig} at $T_A = 121^\circ\text{C}$ for 4 hrs.	JESD22-A102
9. Temperature Cycling	-55°C to +125°C dwelled for 30 min. and transferred for 5min. total 10 cycles.	MIL-STD-750D METHOD-1051
10. Forward Surge	8.3ms single half sine-wave one surge.	MIL-STD-750D METHOD-4066-2
11. Humidity	at $T_A = 85^\circ\text{C}$, RH=85% for 1000hrs.	MIL-STD-750D METHOD-1021
12. High Temperature Storage Life	at 175°C for 1000 hrs.	MIL-STD-750D METHOD-1031