

1.5SMC6.8A  
THRU  
1.5SMC220A

SURFACE MOUNT  
UNI-DIRECTIONAL  
GLASS PASSIVATED JUNCTION  
SILICON TRANSIENT  
VOLTAGE SUPPRESSOR  
1500 WATTS, 6.8 THRU 220 VOLTS

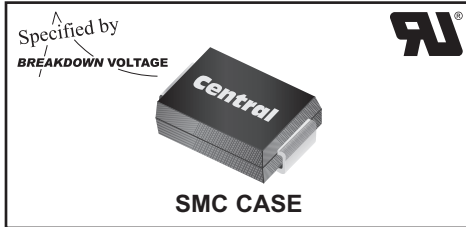

www.centrasemi.com



**DESCRIPTION:**

The CENTRAL SEMICONDUCTOR 1.5SMC6.8A Series types are Surface Mount Uni-Directional Glass Passivated Junction Transient Voltage Suppressors designed to protect voltage sensitive components from high voltage transients.

**THIS DEVICE IS MANUFACTURED WITH A GLASS PASSIVATED CHIP FOR OPTIMUM RELIABILITY.**

Note: For Bi-directional devices, please refer to the 1.5SMC6.8CA Series data sheet.

**MARKING CODE: SEE ELECTRICAL CHARACTERISTICS TABLE**

• This series is UL listed, UL file number E130224

**MAXIMUM RATINGS:** ( $T_A=25^\circ\text{C}$  unless otherwise noted)  
Peak Power Dissipation (Note 1)  
Peak Forward Surge Current (JEDEC Method)  
Operating and Storage Junction Temperature

SYMBOL		UNITS
$P_{DM}$	1500	W
$I_{FSM}$	200	A
$T_J, T_{stg}$	-65 to +150	$^\circ\text{C}$

**ELECTRICAL CHARACTERISTICS:** ( $T_A=25^\circ\text{C}$  unless otherwise noted)

TYPE	BREAKDOWN VOLTAGE			TEST CURRENT	WORKING PEAK REVERSE VOLTAGE	MAXIMUM REVERSE LEAKAGE CURRENT @ $V_{RWM}$	MAXIMUM REVERSE SURGE CURRENT (Note 1)	MAXIMUM REVERSE VOLTAGE @ $I_{RSM}$	MAXIMUM TEMPERATURE COEFFICIENT OF $V_{BR}$	MARKING CODE
	$V_{BR} @ I_T$									
	MIN (V)	NOM (V)	MAX (V)	$I_T$ (mA)	$V_{RWM}$ (V)	$I_R$ ( $\mu\text{A}$ )	$I_{RSM}$ (A)	$V_{RSM}$ (V)	$\theta_{VZ}$ (% / $^\circ\text{C}$ )	
1.5SMC6.8A	6.45	6.8	7.14	10	5.8	1000	143	10.5	0.057	C6V8A
1.5SMC7.5A	7.13	7.5	7.88	10	6.4	500	132	11.3	0.061	C7V5A
1.5SMC8.2A	7.79	8.2	8.61	10	7.02	200	124	12.1	0.065	C8V2A
1.5SMC9.1A	8.65	9.1	9.55	1.0	7.78	50	112	13.4	0.068	C9V1A
1.5SMC10A	9.5	10	10.5	1.0	8.55	10	103	14.5	0.073	C10A
1.5SMC11A	10.5	11	11.6	1.0	9.4	5	96	15.6	0.075	C11A
1.5SMC12A	11.4	12	12.6	1.0	10.2	5	90	16.7	0.078	C12A
1.5SMC13A	12.4	13	13.7	1.0	11.1	5	82	18.2	0.081	C13A
1.5SMC15A	14.3	15	15.8	1.0	12.8	5	71	21.2	0.084	C15A
1.5SMC16A	15.2	16	16.8	1.0	13.6	5	67	22.5	0.086	C16A
1.5SMC18A	17.1	18	18.9	1.0	15.3	5	59.5	25.2	0.088	C18A
1.5SMC20A	19.0	20	21.0	1.0	17.1	5	54	27.7	0.090	C20A
1.5SMC22A	20.9	22	23.1	1.0	18.8	5	49	30.6	0.092	C22A
1.5SMC24A	22.8	24	25.2	1.0	20.5	5	45	33.2	0.094	C24A
1.5SMC27A	25.7	27	28.4	1.0	23.1	5	40	37.5	0.096	C27A
1.5SMC30A	28.5	30	31.5	1.0	25.6	5	36	41.4	0.097	C30A
1.5SMC33A	31.4	33	34.7	1.0	28.2	5	33	45.7	0.098	C33A
1.5SMC36A	34.2	36	37.8	1.0	30.8	5	30	49.9	0.099	C36A
1.5SMC39A	37.1	39	41	1.0	33.3	5	28	53.9	0.100	C39A

Notes: (1) Non-repetitive 10x1,000 $\mu\text{s}$  pulse.

R6 (20-November 2009)

**1.5SMC6.8A  
THRU  
1.5SMC220A**

**SURFACE MOUNT  
UNI-DIRECTIONAL  
GLASS PASSIVATED JUNCTION  
SILICON TRANSIENT  
VOLTAGE SUPPRESSOR  
1500 WATTS, 6.8 THRU 220 VOLTS**



**ELECTRICAL CHARACTERISTICS - Continued:**

TYPE	BREAKDOWN VOLTAGE $V_{BR} @ I_T$			TEST CURRENT $I_T$ (mA)	WORKING PEAK REVERSE VOLTAGE $V_{RWM}$ (V)	MAXIMUM REVERSE LEAKAGE CURRENT @ $V_{RWM}$ $I_R$ ( $\mu$ A)	MAXIMUM REVERSE SURGE CURRENT (Note 1) $I_{RSM}$ (A)	MAXIMUM REVERSE VOLTAGE @ $I_{RSM}$ $V_{RSM}$ (V)	MAXIMUM TEMPERATURE COEFFICIENT OF $V_{BR}$ $\theta_{VZ}$ (% / $^{\circ}$ C)	MARKING CODE
	MIN (V)	NOM (V)	MAX (V)							
1.5SMC43A	40.9	43	45.2	1.0	36.8	5	25.3	59.3	0.101	C43A
1.5SMC47A	44.7	47	49.4	1.0	40.2	5	23.2	64.8	0.101	C47A
1.5SMC51A	48.5	51	53.6	1.0	43.6	5	21.4	70.1	0.102	C51A
1.5SMC56A	53.2	56	58.8	1.0	47.8	5	19.5	77	0.103	C56A
1.5SMC62A	58.9	62	65.1	1.0	53.0	5	17.7	85	0.104	C62A
1.5SMC68A	64.6	68	71.4	1.0	58.1	5	16.3	92	0.104	C68A
1.5SMC75A	71.3	75	78.8	1.0	64.1	5	14.6	103	0.105	C75A
1.5SMC82A	77.9	82	86.1	1.0	70.1	5	13.3	113	0.105	C82A
1.5SMC91A	86.5	91	95.5	1.0	77.8	5	12	125	0.106	C91A
1.5SMC100A	95.0	100	105	1.0	85.5	5	11	137	0.106	C100A
1.5SMC110A	104.5	110	115.5	1.0	94.0	5	9.9	152	0.107	C110A
1.5SMC120A	114	120	126	1.0	102	5	9.1	165	0.107	C120A
1.5SMC130A	123.5	130	136.5	1.0	111	5	8.4	179	0.107	C130A
1.5SMC150A	142.5	150	157.5	1.0	128	5	7.2	207	0.108	C150A
1.5SMC160A	152	160	168	1.0	136	5	6.8	219	0.108	C160A
1.5SMC170A	161.5	170	178.5	1.0	145	5	6.4	234	0.108	C170A
1.5SMC180A	171	180	189	1.0	154	5	6.1	246	0.108	C180A
1.5SMC200A	190	200	210	1.0	171	5	5.5	274	0.108	C200A
1.5SMC220A	209	220	231	1.0	185	5	4.6	328	0.108	C220A

**SMC CASE - MECHANICAL OUTLINE**

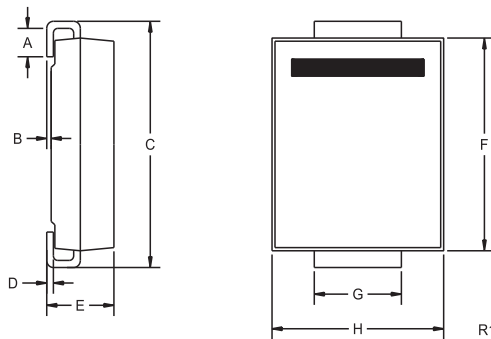

SYMBOL	DIMENSIONS		DIMENSIONS	
	INCHES		MILLIMETERS	
	MIN	MAX	MIN	MAX
A	0.030	0.060	0.76	1.52
B	0.004	0.008	0.10	0.20
C	0.305	0.320	7.75	8.13
D	0.006	0.012	0.15	0.31
E	0.079	0.103	2.00	2.62
F	0.260	0.280	6.60	7.11
G	0.108	0.124	2.75	3.15
H	0.220	0.245	5.59	6.22

SMC (REV: R1)

R6 (20-November 2009)

1.5SMC6.8A  
THRU  
1.5SMC220A



SURFACE MOUNT  
UNI-DIRECTIONAL  
GLASS PASSIVATED JUNCTION  
SILICON TRANSIENT  
VOLTAGE SUPPRESSOR  
1500 WATTS, 6.8 THRU 220 VOLTS



### TYPICAL ELECTRICAL CHARACTERISTICS

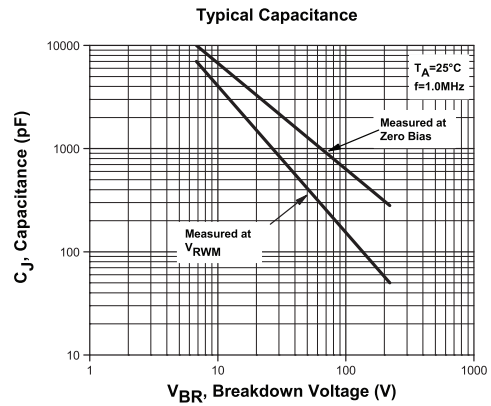
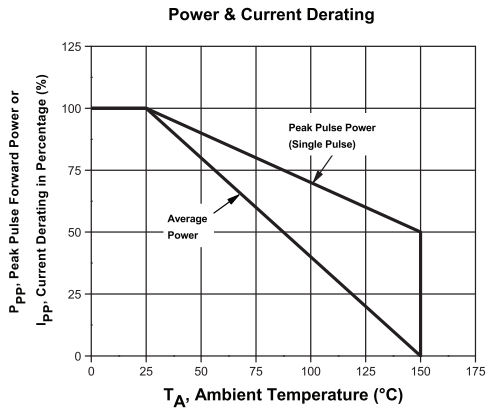
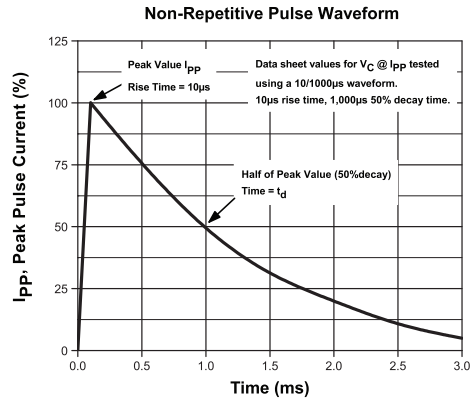
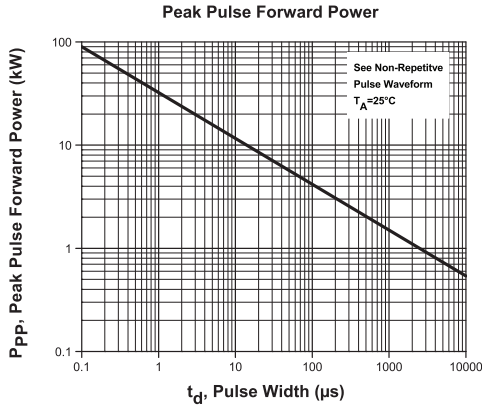

R6 (20-November 2009)