

# SN54BCT125, SN54BCT126 SN74BCT125, SN74BCT126 QUADRUPLE BUS BUFFER GATES WITH 3-STATE OUTPUTS

D0133, SEPTEMBER 1988 REVISED MAY 1989

- State of the Art BICMOS Design Significantly Reduces I<sub>CCZ</sub>
- 3-State Outputs Drive Bus Lines or Buffer Memory Address Registers
- ESD Protection Exceeds 2000 V per MIL-STD-883C Method 3015
- Package Options Include Standard Plastic and Ceramic 300-mil DIPs
- Dependable Texas Instruments Quality and Reliability

## description

These bus buffers feature independent line drivers with three-state outputs. Each 'BCT125 output is disabled when the associated  $\bar{G}$  is high, and each 'BCT126 output is disabled when the associated G is low.

The SN54BCT125 and SN54BCT126 are characterized for operation over the full military temperature range of  $-55^{\circ}\text{C}$  to  $125^{\circ}\text{C}$ . The SN74BCT125 and SN74BCT126 are characterized for operation from  $0^{\circ}\text{C}$  to  $70^{\circ}\text{C}$ .

### FUNCTION TABLES

**'BCT125  
(EACH BUFFER)**

INPUTS		OUTPUT
$\bar{G}$	A	Y
L	H	H
L	L	L
H	X	Z

**'BCT126  
(EACH BUFFER)**

INPUTS		OUTPUT
G	A	Y
H	H	H
H	L	L
L	X	Z

H = high level, L = low level, X = irrelevant

### logic symbols†

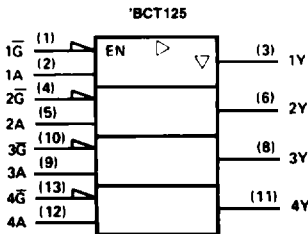

SN54BCT125, SN54BCT126 ... J PACKAGE  
SN74BCT125, SN74BCT126 ... N PACKAGE  
(TOP VIEW)

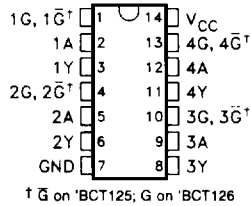

†  $\bar{G}$  on 'BCT125; G on 'BCT126

SN54BCT125, SN54BCT126 ... FK PACKAGE  
(TOP VIEW)

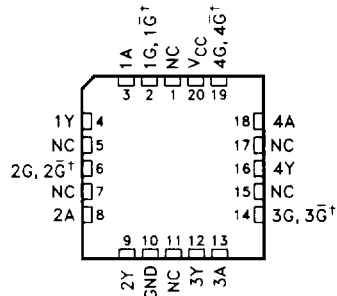

†  $\bar{G}$  on 'BCT125; G on 'BCT126  
NC—No internal connection

† These symbols are in accordance with ANSI/IEEE Std 91-1984 and IEC Publication 617-12. Pin numbers shown are for J and N packages.

PRODUCTION DATA documents contain information current as of publication date. Products conform to specifications per the terms of Texas Instruments standard warranty. Production processing does not necessarily include testing of all parameters.



POST OFFICE BOX 655303 • DALLAS, TEXAS 75265

Copyright © 1989, Texas Instruments Incorporated

**SN54BCT125, SN54BCT126  
SN74BCT125, SN74BCT126  
QUADRUPLE BUS BUFFER GATES WITH 3-STATE OUTPUTS**

logic diagrams (positive logic)

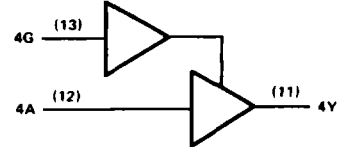
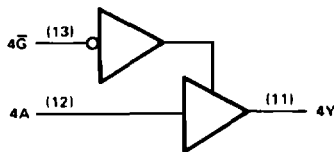
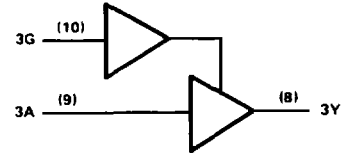
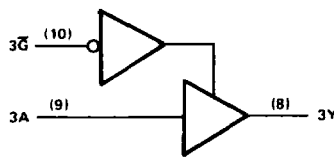
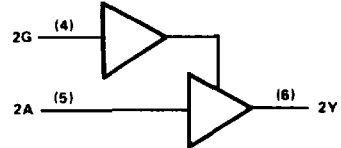
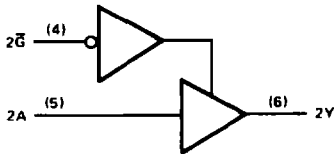
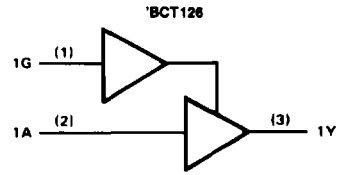
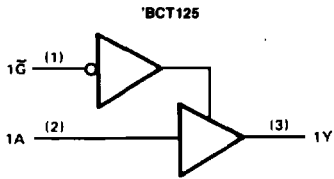

Pin numbers shown are for J and N packages.

**absolute maximum ratings over operating free-air temperature range (unless otherwise noted)†**

Supply voltage, $V_{CC}$ .....	-0.5 V to 7 V
Input voltage (see Note 1) .....	-0.5 V to 7 V
Voltage applied to any output in the disabled or power-off state .....	-0.5 V to 5.5 V
Voltage applied to any output in the high state .....	-0.5 V to $V_{CC}$
Current into any output in the low state: SN54BCT125, SN54BCT126 .....	96 mA
SN74BCT125, SN74BCT126 .....	128 mA
Operating free-air temperature range: SN54BCT125, SN54BCT126 .....	-55°C to 125°C
SN74BCT125, SN74BCT126 .....	0°C to 70°C
Storage temperature range .....	-65°C to 150°C

† Stresses beyond those listed under "absolute maximum ratings" may cause permanent damage to the device. These are stress ratings only and functional operation of the device at these or any other conditions beyond those indicated under "recommended operating conditions" is not implied. Exposure to absolute-maximum-rated conditions for extended periods may affect device reliability.

Note 1: The input negative voltage rating may be exceeded if the input clamp current rating is observed.

SN54BCT125, SN54BCT126  
SN74BCT125, SN74BCT126  
**QUADRUPLE BUS BUFFER GATES WITH 3-STATE OUTPUTS**

**recommended operating conditions**

		SN54BCT125 SN54BCT126			SN74BCT125 SN74BCT126			UNIT
		MIN	NOM	MAX	MIN	NOM	MAX	
V <sub>CC</sub>	Supply voltage	4.5	5	5.5	4.5	5	5.5	V
V <sub>IH</sub>	High-level input voltage	2			2			V
V <sub>IL</sub>	Low-level input voltage			0.8			0.8	V
I <sub>IK</sub>	Input clamp current			-18			-18	mA
I <sub>OH</sub>	High-level output current			-12			-15	mA
I <sub>OL</sub>	Low-level output current			48			64	mA
T <sub>A</sub>	Operating free-air temperature	-55		125	0		70	°C

**electrical characteristics over recommended operating free-air temperature range  
(unless otherwise noted)**

PARAMETER	TEST CONDITIONS	SN54BCT125			SN74BCT125			UNIT	
		MIN	TYP†	MAX	MIN	TYP†	MAX		
V <sub>IK</sub>	V <sub>CC</sub> = 4.5 V, I <sub>I</sub> = -18 mA			-1.2			-1.2	V	
V <sub>OH</sub>	V <sub>CC</sub> = 4.5 V	I <sub>OH</sub> = -3 mA		2.4	3.3	2.4	3.3	V	
		I <sub>OH</sub> = -12 mA		2	3.2				
		I <sub>OH</sub> = -15 mA				2	3.1		
V <sub>OL</sub>	V <sub>CC</sub> = 4.5 V	I <sub>OL</sub> = 48 mA		0.38	0.55			V	
		I <sub>OL</sub> = 64 mA				0.42	0.55		
I <sub>I</sub>	V <sub>CC</sub> = 5.5 V, V <sub>I</sub> = 5.5 V			0.1			0.1	mA	
I <sub>IH</sub>	V <sub>CC</sub> = 5.5 V, V <sub>I</sub> = 2.7 V			35			25	μA	
I <sub>IL</sub>	V <sub>CC</sub> = 5.5 V, V <sub>I</sub> = 0.5 V			-20			-20	μA	
I <sub>OZH</sub>	V <sub>CC</sub> = 5.5 V, V <sub>O</sub> = 2.7 V			50			50	μA	
I <sub>OZL</sub>	V <sub>CC</sub> = 5.5 V, V <sub>O</sub> = 0.5 V			-50			-50	μA	
I <sub>OS</sub> ‡	V <sub>CC</sub> = 5.5 V, V <sub>O</sub> = 0			-100			-225	mA	
I <sub>CCH</sub>	V <sub>CC</sub> = 5.5 V, Outputs open			19	31		19	31	mA
I <sub>CCL</sub>				46	49		46	49	
I <sub>CCZ</sub>				6	12		6	12	
C <sub>i</sub>				4			4		
C <sub>o</sub>	V <sub>CC</sub> = 5 V, V <sub>O</sub> = 2.5 V or 0.5 V			9			9	pF	

† All typical values are at V<sub>CC</sub> = 5 V, T<sub>A</sub> = 25°C.

‡ Not more than one output should be shorted at a time, and the duration of the short circuit should not exceed one second.

**2**  
**BICMOS Circuits**



**SN54BCT126, SN74BCT126**  
**QUADRUPLE BUS BUFFER GATES WITH 3-STATE OUTPUTS**

**electrical characteristics over recommended operating free-air temperature range**  
**(unless otherwise noted)**

PARAMETER	TEST CONDITIONS		SN54BCT126			SN74BCT126			UNIT	
			MIN	TYP†	MAX	MIN	TYP†	MAX		
$V_{IK}$	$V_{CC} = 4.5 \text{ V}$	$I_I = -18 \text{ mA}$			-1.2			-1.2	V	
$V_{OH}$	$V_{CC} = 4.5 \text{ V}$	$I_{OH} = -3 \text{ mA}$	2.4	3.3		2.4	3.3		V	
		$I_{OH} = -12 \text{ mA}$	2	3.2						
		$I_{OH} = -15 \text{ mA}$				2	3.1			
$V_{OL}$	$V_{CC} = 4.5 \text{ V}$	$I_{OL} = 48 \text{ mA}$		0.38	0.55				V	
		$I_{OL} = 64 \text{ mA}$					0.42	0.55		
$I_I$	$V_{CC} = 0 \text{ V}$	$V_I = 7 \text{ V}$			0.1			0.1	mA	
$I_{IH}$	$V_{CC} = 5.5 \text{ V}$	$V_I = 2.7 \text{ V}$			35			25	$\mu\text{A}$	
$I_{IL}$	$V_{CC} = 5.5 \text{ V}$	$V_I = 0.5 \text{ V}$			-20			-20	$\mu\text{A}$	
$I_{OZH}$	$V_{CC} = 5.5 \text{ V}$	$V_O = 2.7 \text{ V}$			50			50	$\mu\text{A}$	
$I_{OZL}$	$V_{CC} = 5.5 \text{ V}$	$V_O = 0.5 \text{ V}$			-50			-50	$\mu\text{A}$	
$I_{OS}^\ddagger$	$V_{CC} = 5.5 \text{ V}$	$V_O = 0$			-100		225	-100	-225	mA
$I_{CCH}$					21		33	21	33	mA
$I_{CCL}$	$V_{CC} = 5.5 \text{ V}$	Outputs open			35		51	35	51	
$I_{CCZ}$					5		8	5	8	
$C_i$	$V_{CC} = 5 \text{ V}$	$V_I = 2.5 \text{ V or } 0.5 \text{ V}$			4			4		
$C_o$	$V_{CC} = 5 \text{ V}$	$V_O = 2.5 \text{ V or } 0.5 \text{ V}$			9			9		pF

† All typical values are at  $V_{CC} = 5 \text{ V}$ ,  $T_A = 25^\circ\text{C}$ .

‡ Not more than one output should be shorted at a time, and the duration of the short circuit should not exceed one second.

**2**

**BICMOS Circuits**



POST OFFICE BOX 655303 • DALLAS, TEXAS 75265

SN54BCT125, SN54BCT126  
SN74BCT125, SN74BCT126  
**QUADRUPLE BUS BUFFER GATES WITH 3-STATE OUTPUTS**

**'BCT125 switching characteristics (see Figure 1)**

PARAMETER	FROM (INPUT)	TO (OUTPUT)	V <sub>CC</sub> = 5 V, C <sub>L</sub> = 50 pF, R <sub>1</sub> = 500 Ω, R <sub>2</sub> = 500 Ω, T <sub>A</sub> = 25°C			V <sub>CC</sub> = 4.5 V to 5.5 V, C <sub>L</sub> = 50 pF, R <sub>1</sub> = 500 Ω, R <sub>2</sub> = 500 Ω, T <sub>A</sub> = MIN to MAX†			UNIT	
			'BCT125			SN54BCT125		SN74BCT125		
			MIN	TYP	MAX	MIN	MAX	MIN		MAX
t <sub>PLH</sub>	A	Y	1.6	3.5	5.2	1.6	6	1.6	5.7	ns
t <sub>PHL</sub>			2.7	5	6.9	2.7	8	2.7	7.7	
t <sub>PZH</sub>	G	Y	3.4	6.7	9	3.4	11.1	3.4	10.3	ns
t <sub>PZL</sub>			5	8.2	10.4	5	12.8	5	11.7	
t <sub>PHZ</sub>	G	Y	3	5.8	7.4	3	9.4	3	8.9	ns
t <sub>PLZ</sub>			2.8	5.5	7.3	2.8	9.9	2.8	8.6	

**'BCT126 switching characteristics (see Figure 1)**

PARAMETER	FROM (INPUT)	TO (OUTPUT)	V <sub>CC</sub> = 5 V, C <sub>L</sub> = 50 pF, R <sub>1</sub> = 500 Ω, R <sub>2</sub> = 500 Ω, T <sub>A</sub> = 25°C			V <sub>CC</sub> = 4.5 V to 5.5 V, C <sub>L</sub> = 50 pF, R <sub>1</sub> = 500 Ω, R <sub>2</sub> = 500 Ω, T <sub>A</sub> = MIN to MAX†				UNIT
			'BCT126			SN54BCT126		SN74BCT126		
			MIN	TYP	MAX	MIN	MAX	MIN	MAX	
t <sub>PLH</sub>	A	Y	1.5	3.6	4.9	1.5	5.6	1.5	5.4	ns
t <sub>PHL</sub>			2.7	5.3	6.9	2.7	7.7	2.7	7.4	
t <sub>PZH</sub>	G	Y	2.6	4.8	6.4	2.6	7.2	2.6	7	ns
t <sub>PZL</sub>			3.7	6.4	8.3	3.7	10.5	3.7	10	
t <sub>PHZ</sub>	G	Y	3.2	6.6	8.2	3.2	9.6	3.2	9.1	ns
t <sub>PLZ</sub>			3.4	6.5	8	3.4	12.3	3.4	10.7	

† For conditions shown as MIN or MAX, use the appropriate value specified under Recommended Operating Conditions.

**2**

**BiCMOS Circuits**

SN54BCT125, SN54BCT126  
 SN74BCT125, SN74BCT126  
 QUADRUPLE BUS BUFFER GATES WITH 3-STATE OUTPUTS

PARAMETER MEASUREMENT INFORMATION

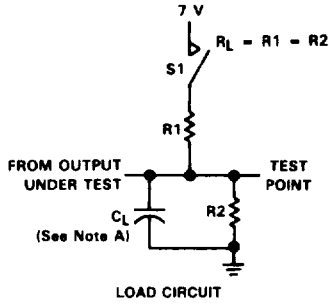

SWITCH POSITION TABLE

TEST	S1
$t_{PLH}$	Open
$t_{PHL}$	Open
$t_{PZH}$	Open
$t_{PZL}$	Closed
$t_{PHZ}$	Open
$t_{PLZ}$	Closed

2

BICMOS Circuits

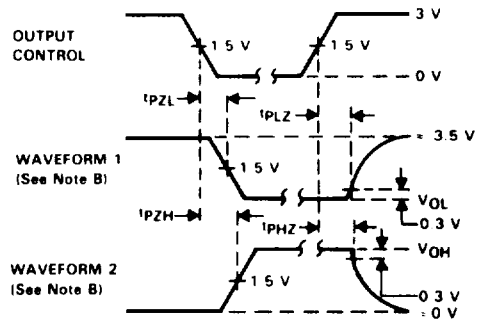
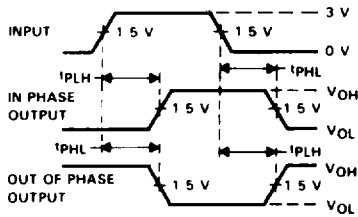

- NOTES: A.  $C_L$  includes probe and jig capacitance.  
 B. Input pulses are supplied by generators having the following characteristics: PRR  $\geq$  10 MHz,  $Z_o = 50 \Omega$ ,  $t_r = 2.5$  ns,  $t_f = 2.5$  ns.  
 C. Waveform 1 is for an output with internal conditions such that the output is low except when disabled by the output control.  
 Waveform 2 is for an output with internal conditions such that the output is high except when disabled by the output control.  
 D. The outputs are measured one at a time with one input transition per measurement.

FIGURE 1. LOAD CIRCUIT AND VOLTAGE WAVEFORMS