

V <sub>RSM</sub>	V <sub>RRM</sub>	I <sub>FRMS</sub> (maximum value for continuous operation)		
		175 A	310 A	310 A
		I <sub>FAV</sub> (sin. 180; T <sub>case</sub> = . . .)		
V	V	100 A (85 °C)	160 A (95 °C)	160 A (95 °C)
500	400	<b>SKKD 100/04</b>	–	–
900	800	<b>SKKD 100/08</b>	<b>SKKD 162/08</b>	<b>SKKE 162/08</b>
1300	1200	<b>SKKD 100/12</b>	<b>SKKD 162/12</b>	<b>SKKE 162/12</b>
1500	1400	<b>SKKD 100/14</b>	<b>SKKD 162/14</b>	<b>SKKE 162/14</b>
1700	1600	<b>SKKD 100/16</b>	<b>SKKD 162/16</b>	<b>SKKE 162/16</b>
1900	1800	<b>SKKD 100/18</b>	<b>SKKD 162/18</b>	<b>SKKE 162/18</b>
2100	2000	–	<b>SKKD 162/20</b>	<b>SKKE 162/20</b>
2300	2200	–	<b>SKKD 162/22</b>	<b>SKKE 162/22</b>

## Rectifier Diode Modules

**SEMIPACK® 1**  
**SKKD 100 SKMD 100<sup>1)</sup>**

**SEMIPACK® 2**  
**SKKD 162 SKND 162<sup>1)</sup>**  
**SKKE 162**

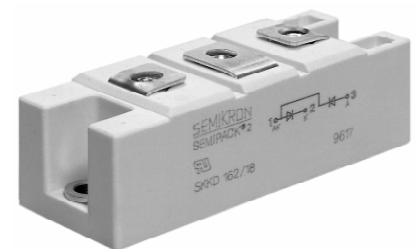

Symbol	Conditions	SKKD 100	SKKD 162 SKKE 162	Units
I <sub>FAV</sub>	sin. 180; T <sub>case</sub> = 85 °C	100	195	A
I <sub>D</sub> <sup>1)</sup>	B2/B6 T <sub>amb</sub> = 45 °C; P 3/180 T <sub>amb</sub> = 35 °C; P 3/180 F P 16/200 F	73 / 91	90 / 115	A
		150 / 190	210 / 260	A
		–	320 / 425	A
I <sub>FSM</sub>	T <sub>vj</sub> = 25 °C; 10 ms	2 500	6 000	A
	T <sub>vj</sub> = 125 °C; 10 ms	2 000	5 000	A
i <sup>2</sup> t	T <sub>vj</sub> = 25 °C; 8,3 ... 10 ms	31 250	180 000	A <sup>2</sup> s
	T <sub>vj</sub> = 125 °C; 8,3 ... 10 ms	20 000	125 000	A <sup>2</sup> s
I <sub>RD</sub>	T <sub>vj max.</sub> ; V <sub>RD</sub> = V <sub>RRM</sub>	5	9	mA
V <sub>F</sub>	T <sub>vj</sub> = 25 °C; (I <sub>F</sub> = . . .); max.	1,35 (300 A)	1,5 (500 A)	V
V <sub>(TO)</sub>	T <sub>vj max.</sub>	0,85	0,85	V
r <sub>T</sub>	T <sub>vj max.</sub>	1,3	1,2	mΩ
R <sub>thjc</sub>	} per diode / per module <sup>2)</sup>	0,35 / 0,175	0,18 / 0,09	°C/W
R <sub>thch</sub>		0,2 / 0,1	0,10 / 0,05	°C/W
T <sub>vj</sub>		– 40 ... + 125	– 40 ... + 135	°C
T <sub>stg</sub>		– 40 ... + 125	– 40 ... + 135	°C
V <sub>isol</sub>		a. c. 50 Hz; r.m.s.; 1 s/1 min to heatsink to terminals } SI (US) units	3600 / 3000 5 (44 lb. in.) ± 15 %	
M <sub>1</sub>		3 (26 lb. in.) ± 15 % <sup>3)</sup>	5 (44 lb. in.) ± 15 % <sup>3)</sup>	Nm
M <sub>2</sub>				
a		5 · 9,81	5 · 9,81	m/s <sup>2</sup>
w	approx.	95	250	g
Case	→ page B 1 – 95; 96	SKKD 100: A 10 (B 1 – 38: SKMD 100: A 33)	SKKD 162: A 23 SKKE 162: A 24 SKND 162: A 57	

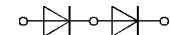

**SKKD**



**SKKE**

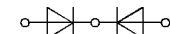

**SKMD**

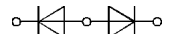

**SKND**

### Features

- Heat transfer through aluminium oxide ceramic isolated metal baseplate
- Hard soldered joints for high reliability
- **SKKD** half bridge connection  
center-tap connections:  
**SKMD** common cathode  
**SKND** common anode
- UL recognized, file no. E 63 532

### Typical Applications

- Non-controllable rectifiers for AC/AC converters
- Line rectifiers for transistorized AC motor controllers
- Field supply for DC motors
- **SKKE**: Free-wheeling diodes

<sup>1)</sup> SKMD 100, SKND 162 available on request

<sup>2)</sup> SKKD types only

<sup>3)</sup> See the assembly instructions

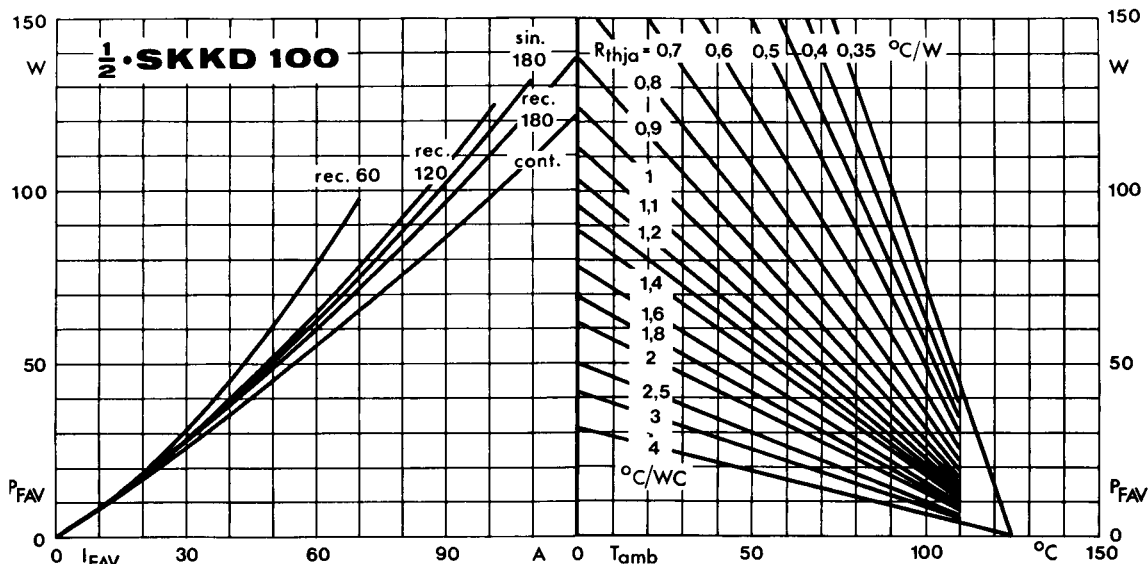

Fig. 11 a Power dissipation per diode vs. forward current and ambient temperature

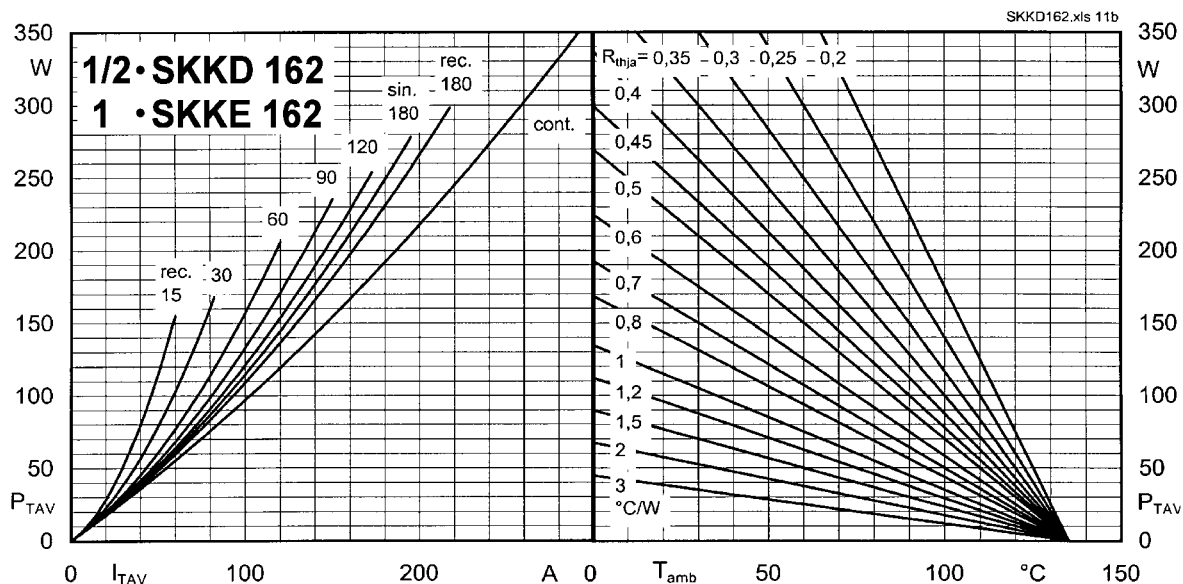

Fig. 11 b Power dissipation per diode vs. forward current and ambient temperature

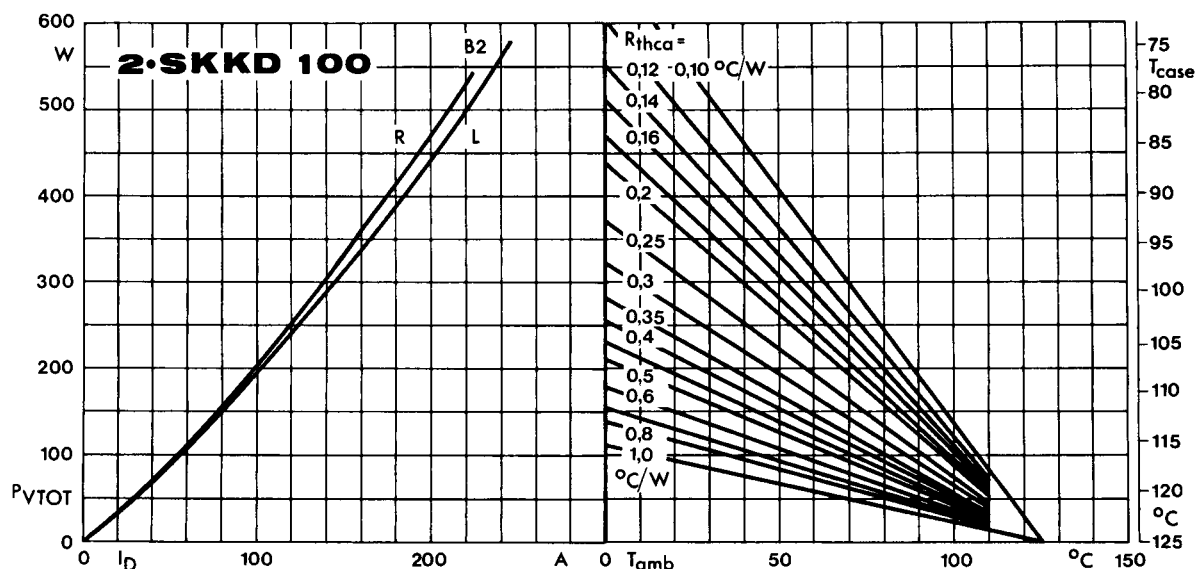

Fig. 12 a Power dissipation of two modules vs. direct current and case temperature

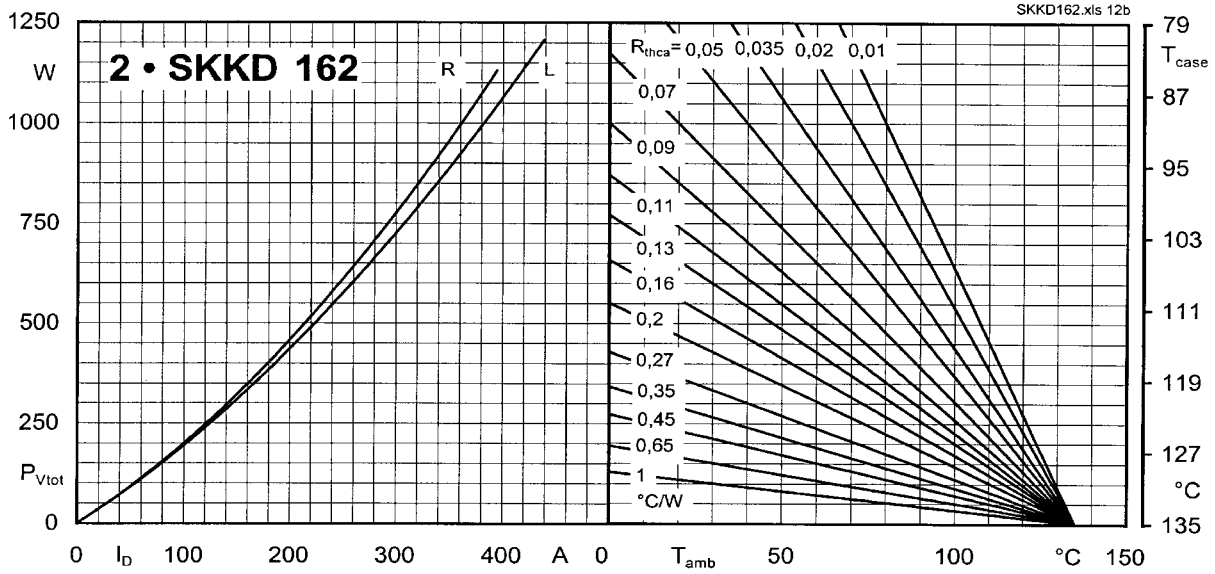

Fig. 12 b Power dissipation of two modules vs. direct current and case temperature

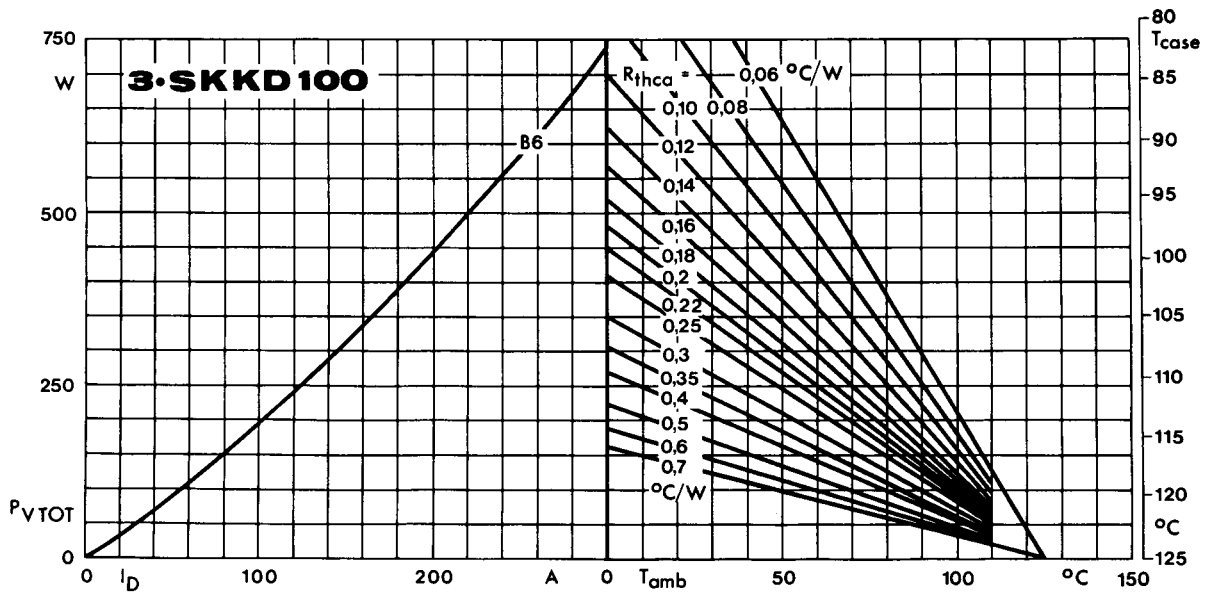

Fig. 13 a Power dissipation of three modules vs. direct current and case temperature

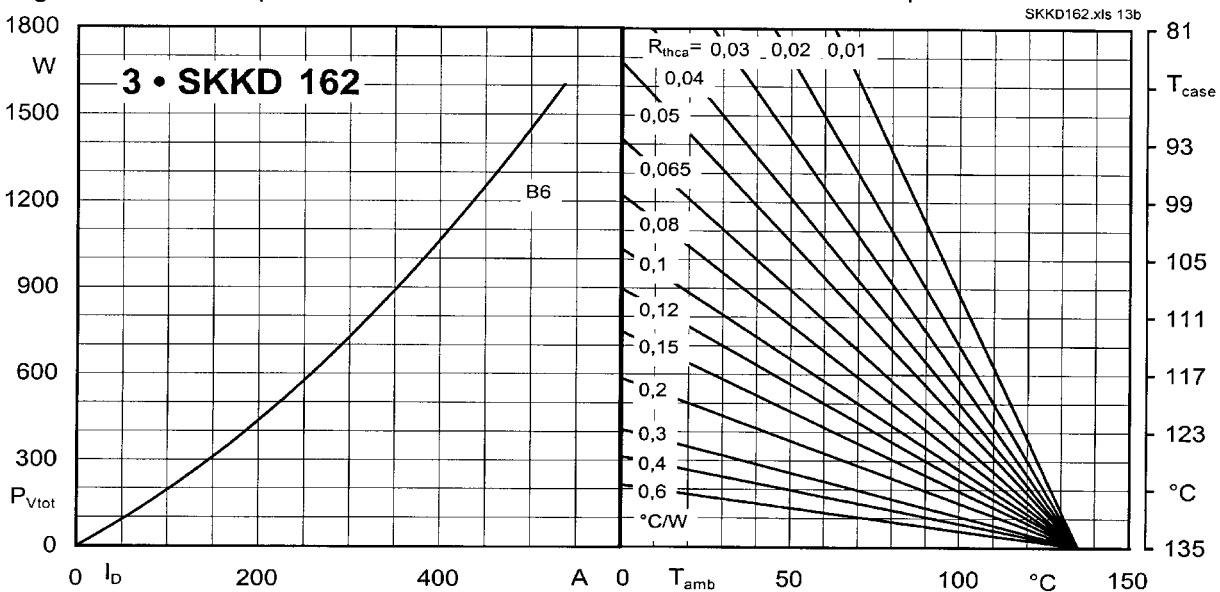

Fig. 13 b Power dissipation of three modules vs. direct current and case temperature

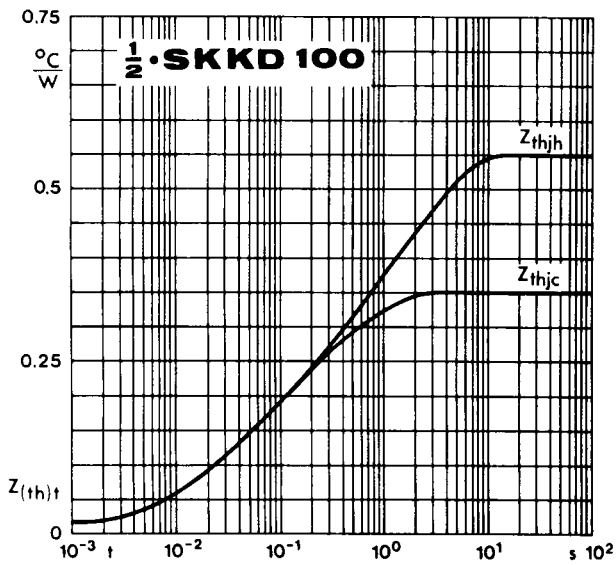

Fig. 14 a Transient thermal impedance vs. time

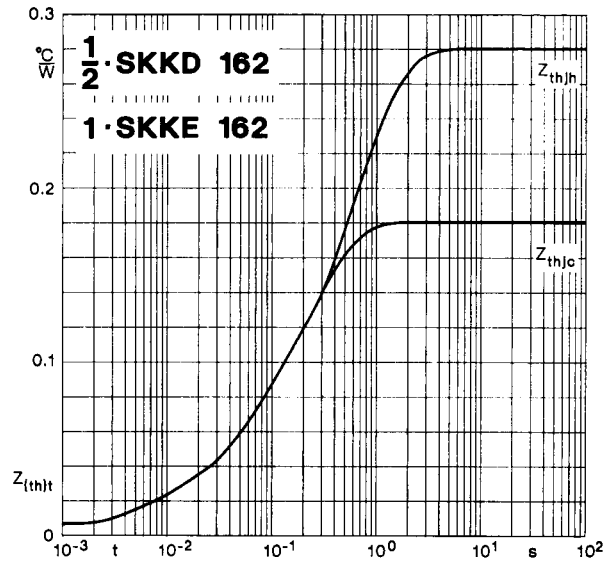

Fig. 14 b Transient thermal impedance vs. time

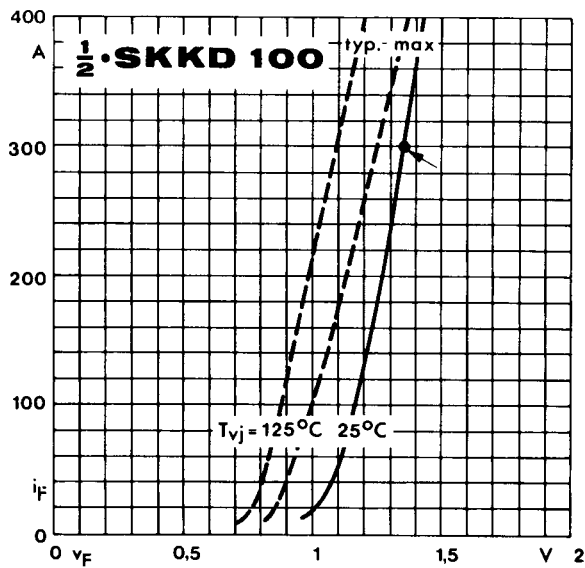

Fig. 15 a Forward characteristics

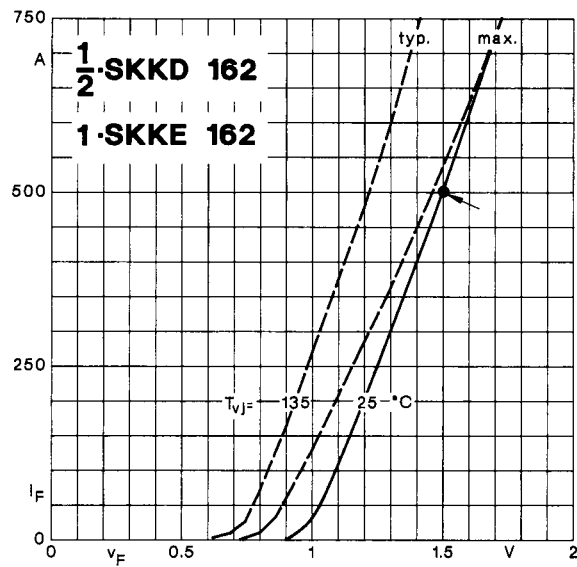

Fig. 15 b Forward characteristics

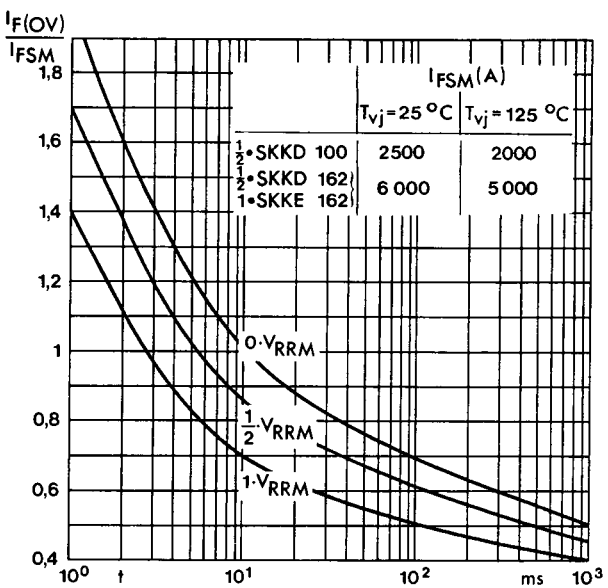

Fig. 16 Surge overload current vs. time

## SKKT 19 ... 105

Case A 5

IEC 192-2: A 77 A

JEDEC: TO-240 AA

SEMIPACK® 1

UL recognized, file no. E 63 532



Dimensions in mm

## SKKT 20/ ... 106/

Case A 46

IEC 192-2: A 77 A

JEDEC: TO-240 AA

SEMIPACK® 1

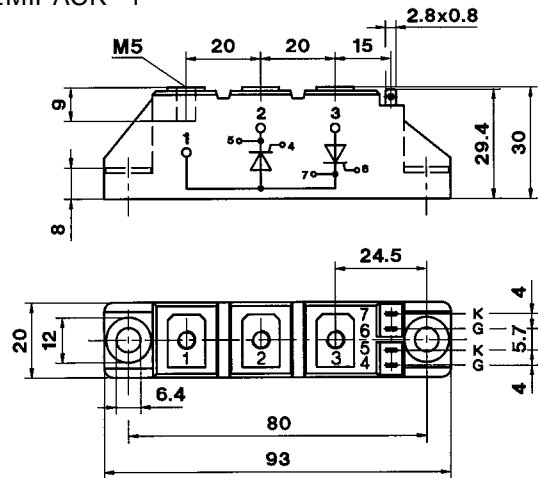

Dimensions in mm

## SKKH 26 ... 105

Case A 6

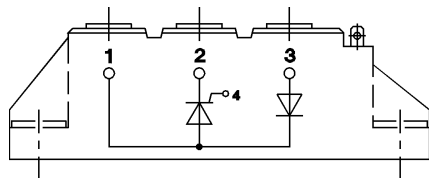

## SKKD 26 ... 100

Case A 10

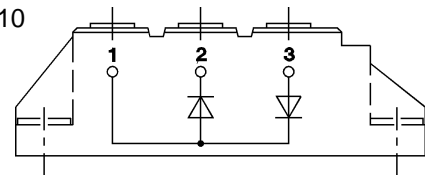

## SKNH 56 ... 91

Case A 7

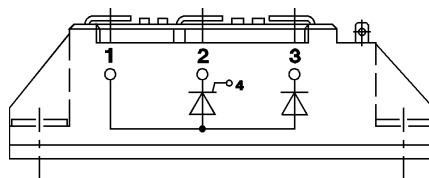

## SKKE 81

Case A 12

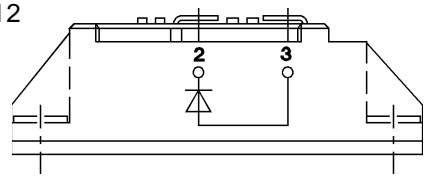

## SKKL 56 ... 105

Case A 9

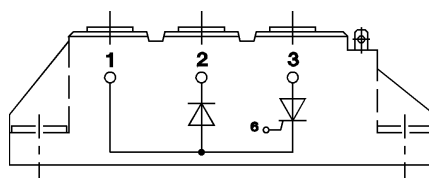

## SKKH 27 ... 106

Case A 47

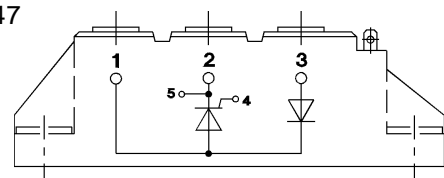

## SKND 46 ... 81

Case A 19

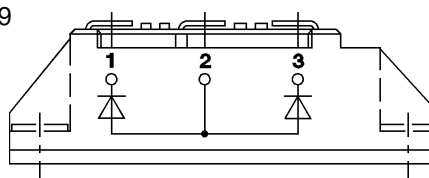

## SKKT 20 B ... 106 B

Case A 48

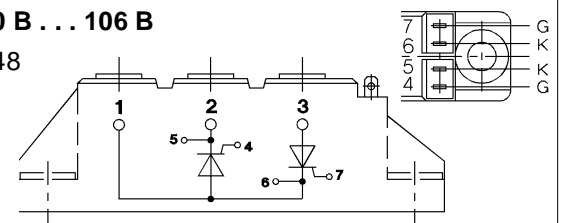

## SKMT 92

Case A 72

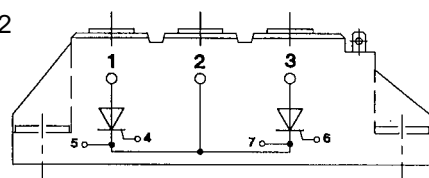

## SKKL 42 ... 106

Case A 59

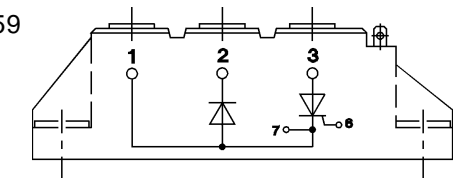



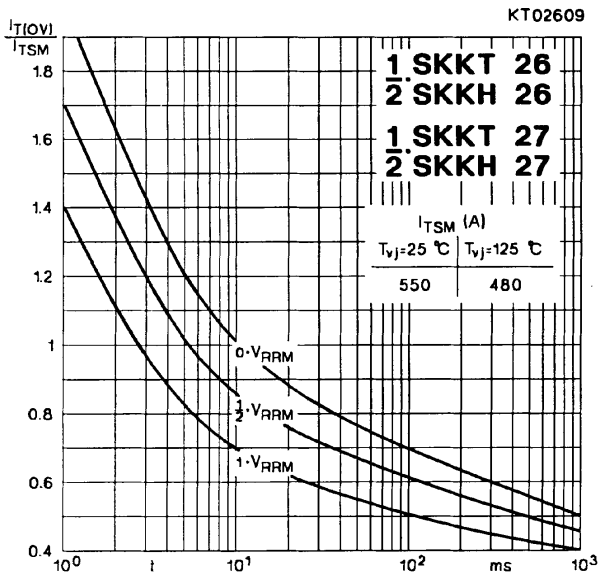

Fig. 9 Surge overload current vs. time

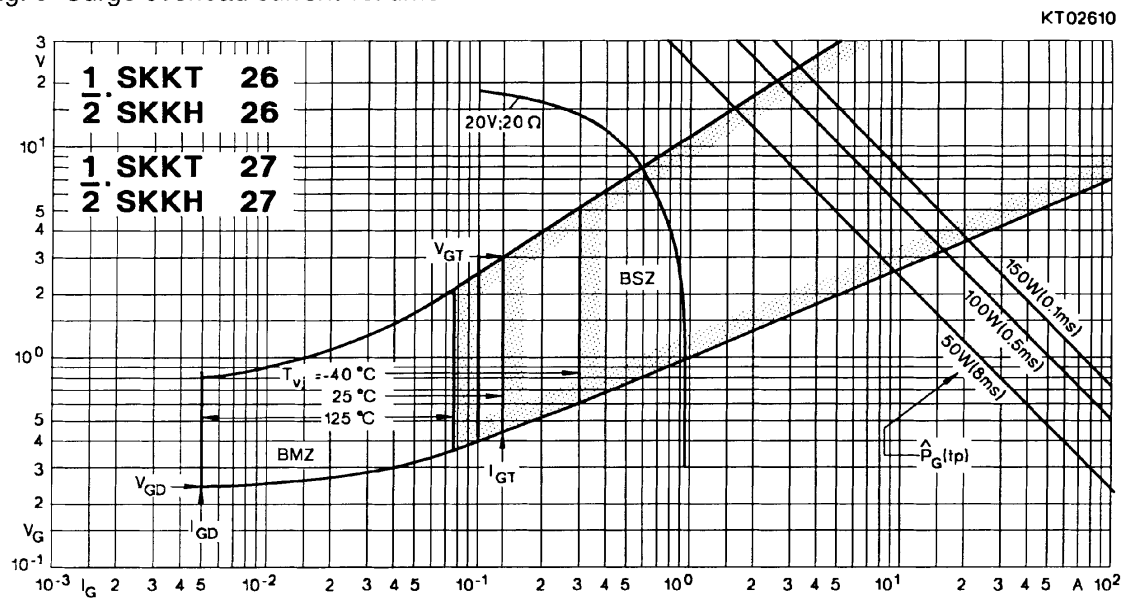

Fig. 10 Gate trigger characteristics

