



MTA 100

TE Internal #: 4-647016-1

TE Internal Description: 11P MTA100 PSTD CONN ASSY LF

Nylon Gold Plated Plug: 2.54mm, With Mating Alignment, MTA 100

[View on TE.com >](#)

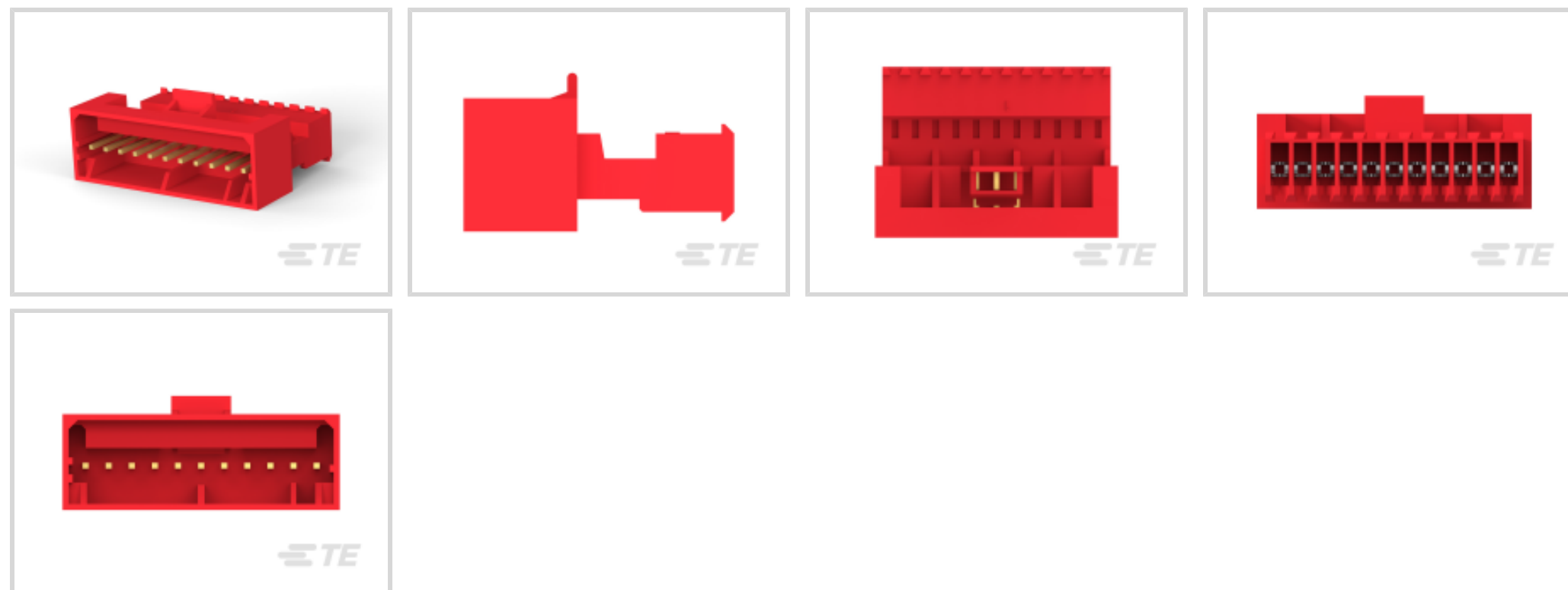

All Nylon Gold Plated Plug: 2.54mm, With Mating Alignment, MTA 100 (10)

Product Compliance

[For compliance documentation, visit the product page on TE.com>](#)

EU RoHS Directive 2011/65/EU	Compliant
EU ELV Directive 2000/53/EC	Compliant
China RoHS 2 Directive MIIT Order No 32, 2016	No Restricted Materials Above Threshold
EU REACH Regulation (EC) No. 1907/2006	Current ECHA Candidate List: JUNE 2023 (235) Candidate List Declared Against: JUL 2021 (219) Does not contain REACH SVHC
Halogen Content	Low Halogen - Br, Cl, F, I < 900 ppm per homogenous material. Also BFR/CFR/PVC Free
Solder Process Capability	Not applicable for solder process capability

Product Compliance Disclaimer

This information is provided based on reasonable inquiry of our suppliers and represents our current actual knowledge based on the information they provided. This information is subject to change. The part numbers that TE has identified as EU RoHS compliant have a maximum concentration of 0.1% by weight in homogenous materials for lead, hexavalent chromium, mercury, PBB, PBDE, DBP, BBP, DEHP, DIBP, and 0.01% for cadmium, or qualify for an exemption to these limits as defined in the Annexes of Directive 2011/65/EU (RoHS2). Finished electrical and electronic equipment products will be CE marked as required by Directive 2011/65/EU. Components may not be CE marked. Additionally, the part numbers that TE has identified as EU ELV compliant have a maximum concentration of 0.1% by weight in homogenous materials for lead, hexavalent chromium, and mercury, and 0.01% for cadmium, or qualify for an exemption to these limits as defined in the Annexes of Directive 2000/53/EC (ELV). Regarding the REACH Regulation, the information TE provides on SVHC in articles for this part number is based on the latest European Chemicals Agency (ECHA) 'Guidance on requirements for substances in articles' posted at this URL: <https://echa.europa.eu/guidance-documents/guidance-on-reach>

## Also in the Series | MTA 100



Connector Caps & Covers(69)



Insertion & Extraction Tools(2)



PCB Connector Keying(1)



PCB Headers & Receptacles(440)

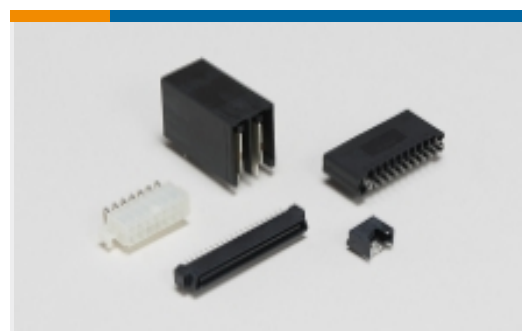

Standard Rectangular Connectors(495)

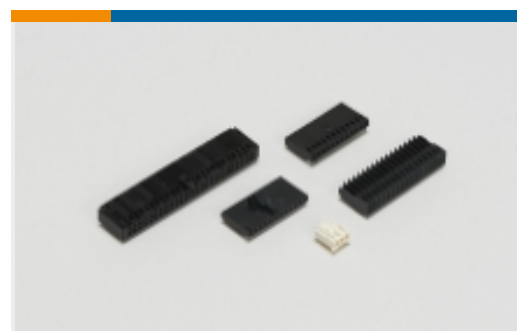

Wire-to-Board Connector Assemblies & Housings(1)



Wire-to-Board Connector Contacts(8)

## Customers Also Bought

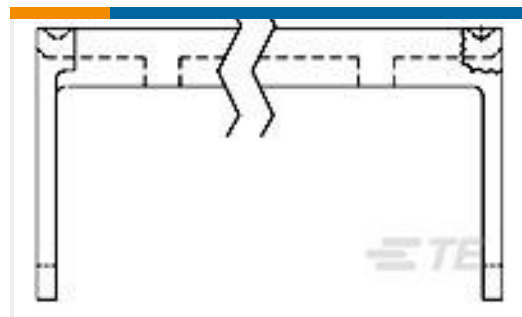

TE Part #7-1437023-1  
622-1431=FSKT IDC S 14 SR



TE Part #3-647476-9  
09P MTA156 PSTD CONN 18AWG LF



TE Part #4-647016-6  
16P MTA100 PSTD CONN ASSY LF

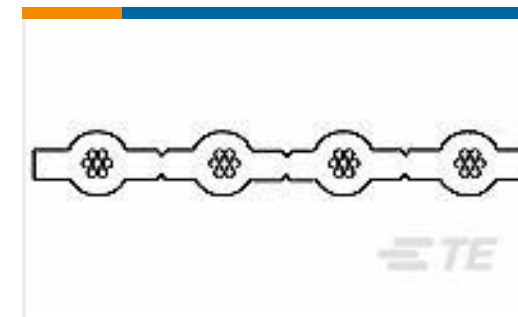

TE Part #57744-5  
Madison Spec 100-7244 Rev. 2



TE Part #3-641522-9  
09P MTA156 POST CON ASSY ORNG



TE Part #3-647481-6  
06P MTA156 PSTD CONN 18AWG LF



TE Part #3-647481-9  
09P MTA156 PSTD CONN 18AWG LF



TE Part #306039-000  
44AM1121-18-9/96-9

## Documents

### Product Drawings

11P MTA100 PSTD CONN ASSY LF

English

### CAD Files

3D PDF

3D



**Customer View Model**

[ENG\\_CVM\\_CVM\\_4-647016-1\\_H.2d\\_dxf.zip](#)

English

**Customer View Model**

[ENG\\_CVM\\_CVM\\_4-647016-1\\_H.3d\\_igs.zip](#)

English

**Customer View Model**

[ENG\\_CVM\\_CVM\\_4-647016-1\\_H.3d\\_stp.zip](#)

English

By downloading the CAD file I accept and agree to the [Terms and Conditions](#) of use.

---

**Product Specifications**

[Application Specification](#)

English

---

**Agency Approvals**

[Agency Approval Document](#)

English