

A-14-13

EXAMPLE & ORDERING CODE

PHONE JACKS PHJ - 8 P 8 C - 1 S - 8 - 4

NUMBER OF POSITIONS:
= 4
= 6
= 8
= 10

NUMBER OF CONTACTS:
= 2
= 4
= 6
= 8
= 10

NUMBER OF PORTS: 1 THROUGH 12

OPTIONS:
UNSHIELDED = BLANK
SHIELDED = S

BODY STYLE: SEE CATALOG PAGES 108-122

COLOR:
BLACK = BLANK
GRAY = G
(FOR COUPLER ONLY): RED = R
BLUE = B
YELLOW = Y
GREEN = N
WHITE = W
IVORY = I

PLATING:
6µ" OF GOLD = BLANK
10µ" OF GOLD = 1
15µ" OF GOLD = 2
20µ" OF GOLD = 3
30µ" OF GOLD = 4
(STANDARD) 50µ" OF GOLD = 5

TELEPHONE JACKS & PLUGS

6

SPECIFICATIONS

MATERIAL AND FINISH:
Shell: (shielded)
Material: PBT Mixed 15% Glass Fiber
Rating: UL 94V-0
Shield: Tin Plated Phosphor Bronze
Shell: (unshielded)
Material: PBT mixed 15% Glass Fiber
Rating: UL 94V-0

Contacts:
Material: 0.38mm flat pin Phosphor Bronze Alloy
Plating: Gold 30µ"
Tin 150µ"
Nickel 50µ"

MECHANICAL:
Mating Force: 2 contacts = 350 g
4 contacts = 500 g
6 contacts = 750 g
8 contacts = 900 g
Retention Force: (between jack and plug) 7.7 kg

ELECTRICAL SPECIFICATIONS:
Rated Current: 1.5A
Insulator Resistance: 500 Megaohm min.
Contact Resistance: 20 milliohm max. per contact
Dielectric Withstanding Strength: 1000 VAC RMS @ 60 Hz
Shield: Shielding effective from 30 MHz



59 Lakeside Avenue • West Orange, N.J. 07052-0539 • 201 736-5722 • FAX: 201 736-8930

Right Angle

PHJ-6P6C-1-F-5

(shown)

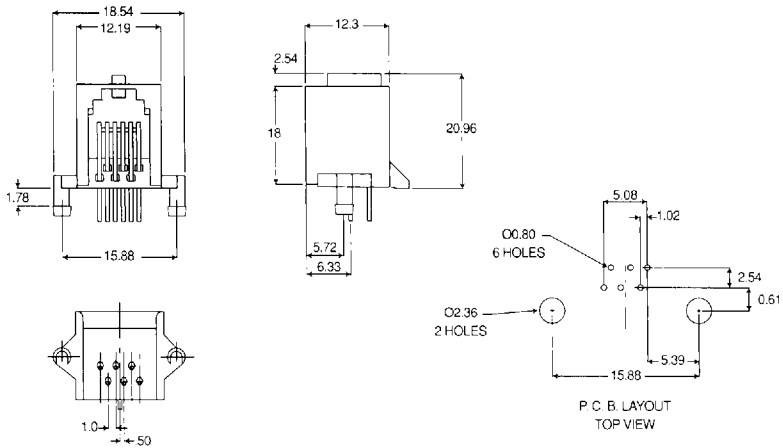

Also available in 4P4C.

PHJ-8P8C-1-A-5

(shown)

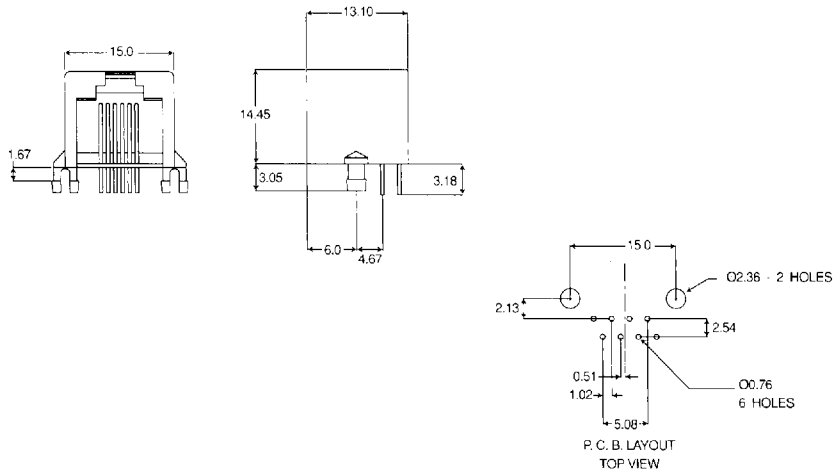
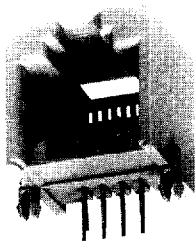

Also available in 6P6C.

PHJ-6P6C-1-Q-5

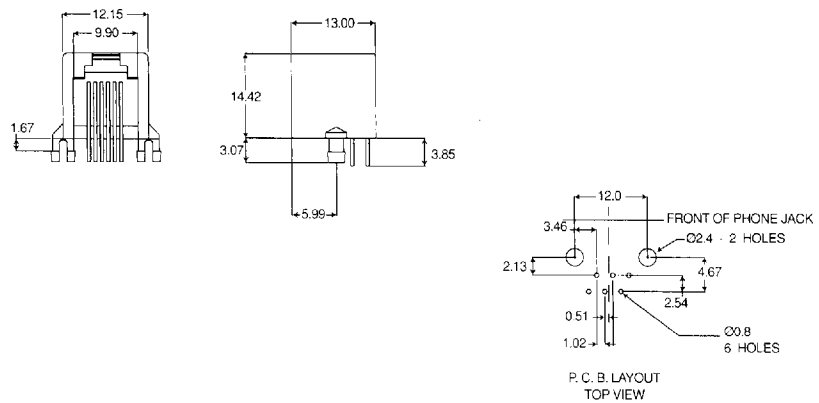
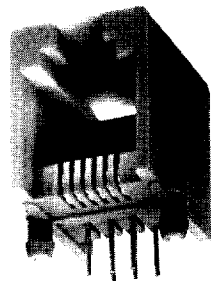

Specifications subject to change without notice. Dimensions in mm.

Right Angle

PHJ-8P8C-1-8-5

(shown)

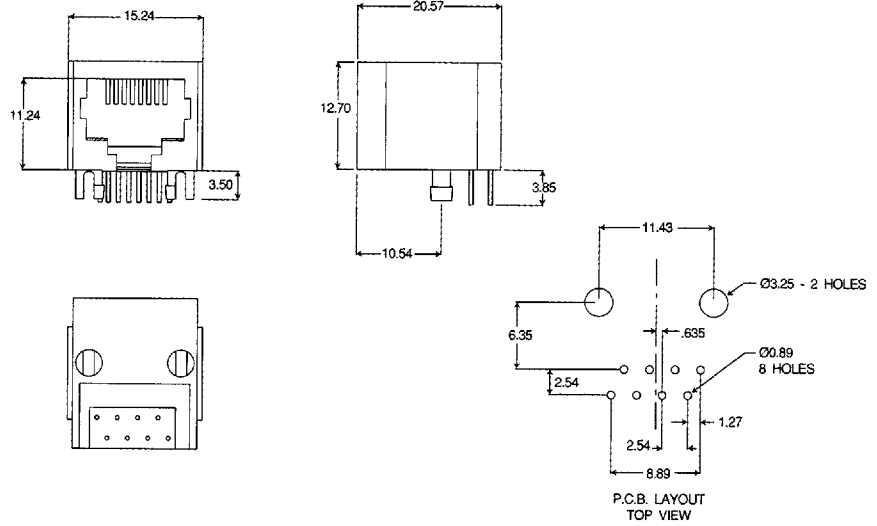
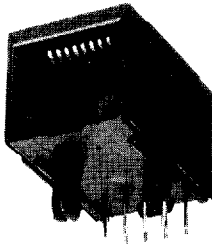

PHJ-8P8C-1S-8-5

(shown)

Fully Shielded

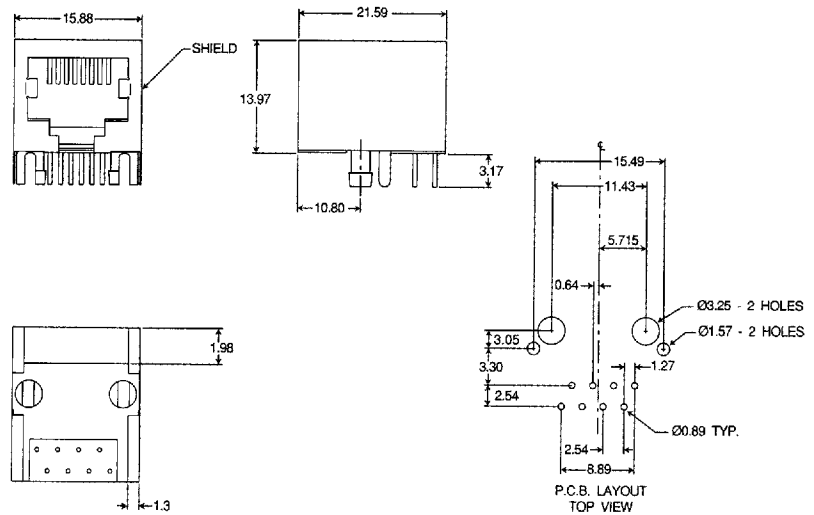
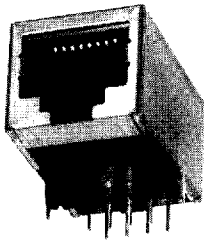

PHJ-8P8C-1M-8-4

(shown)

Fully Shielded
Panel Grounding Tabs

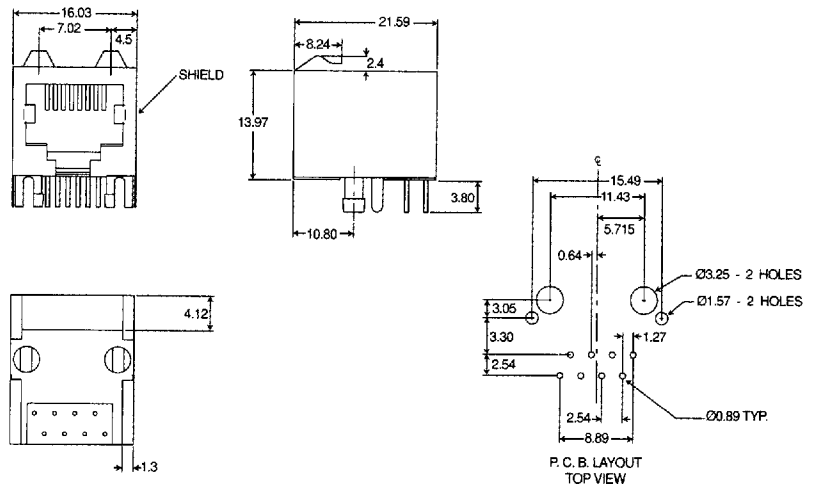
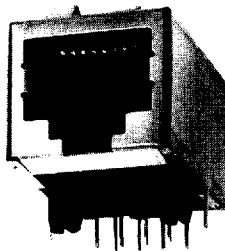

Specifications subject to change without notice. Dimensions in mm.

PDI[®]
Power Dynamics, Inc.

59 Lakeside Avenue • West Orange, N.J. 07052-0539 • 201 736-5722 • FAX: 201 736-8930

D 06F ■ 7286705 0001473 533 ■

6 TELEPHONE JACKS & PLUGS

Right Angle



PHJ-10P10C-1-G-5

(shown)

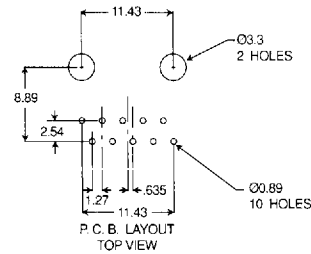
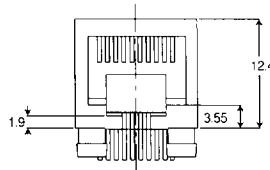
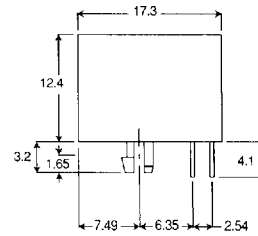
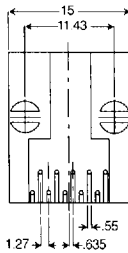
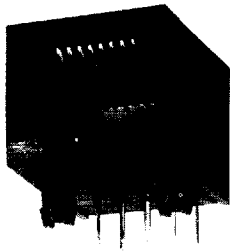

Also available in 4P4C, 6P6C, 8P8C, 10P10C.

PHJ-6P6C-2-G-5

(shown)

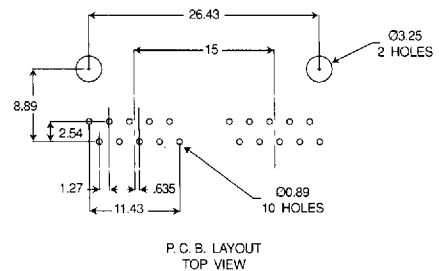
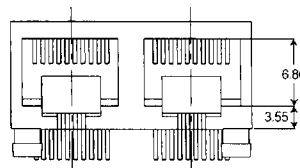
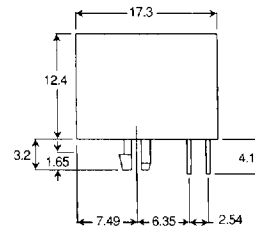
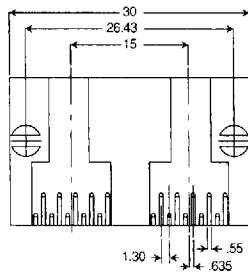
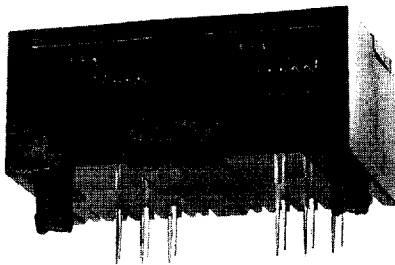

Also available in 4P4C, 6P6C, 8P8C, 10P10C.

Specifications subject to change without notice. Dimensions in mm.

Right Angle

PHJ-8P8C-4-8-5

(shown)

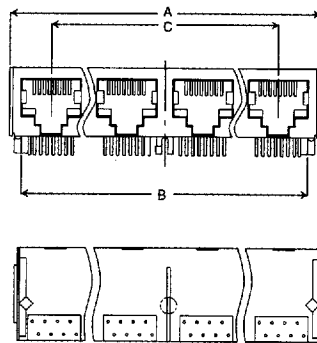
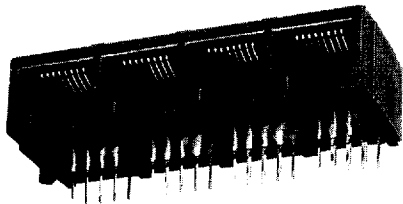

NO. OF PORTS	DIMENSIONS		
	A	B	C
2	31.12	13.97	25.40
4	59.06	41.91	53.34
6	87.00	69.85	81.28
8	114.94	97.79	109.22
10	142.24	125.73	137.16
12	170.78	153.67	165.10

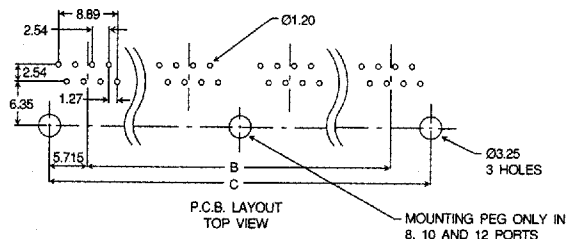
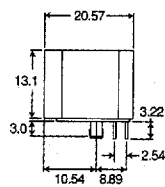

PHJ-8P8C-4S-8-5

(shown)

Fully Shielded

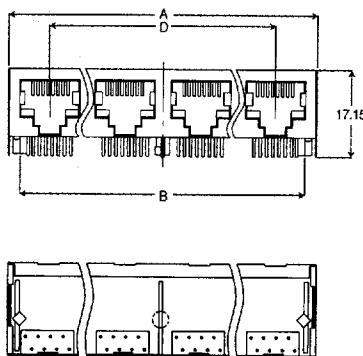
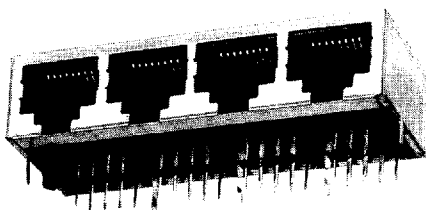

NO. OF PORTS	DIMENSIONS			
	A	B	C	D
2	31.12	25.40	30.87	13.97
4	59.06	53.34	58.81	41.91
6	87.00	81.28	86.75	69.85
8	114.94	109.22	114.69	97.79
10	142.88	137.16	142.63	125.73
12	170.82	165.10	170.57	153.67

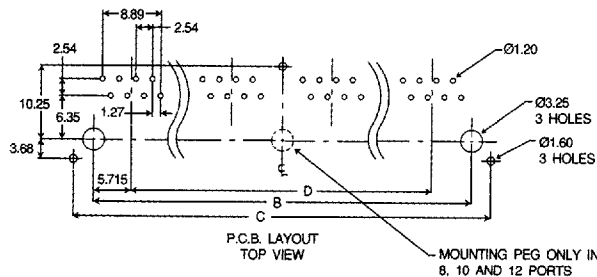
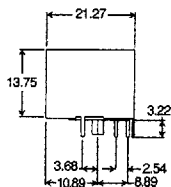

Specifications subject to change without notice. Dimensions in mm.

PDI[®]
Power Dynamics, Inc.

59 Lakeside Avenue • West Orange, N.J. 07052-0539 • 201 736-5722 • FAX: 201 736-8930

D

06F ■ 7286705 0001475 306 ■

6 TELEPHONE JACKS & PLUGS

Right Angle



PHJ-8P8C-4A-8-5 Fully Shielded Panel Grounding Tabs

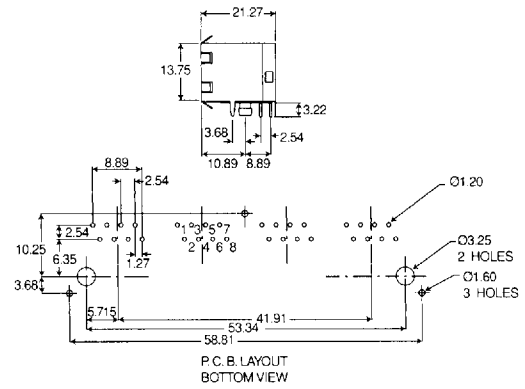
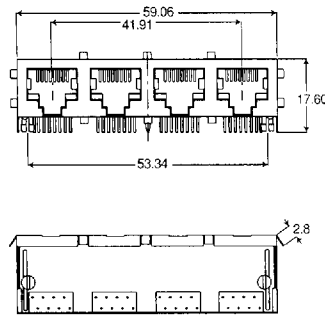
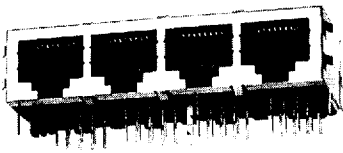

PHJ-8P8C-8A-8-5 Fully Shielded Panel Grounding Tabs

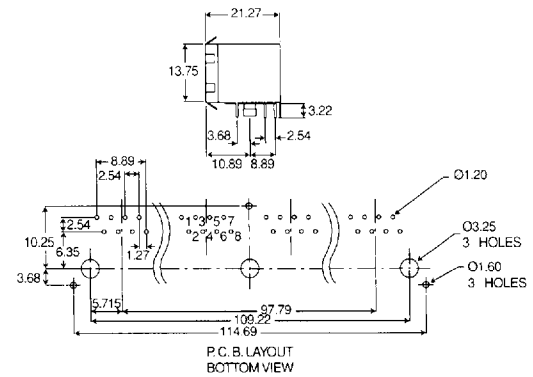
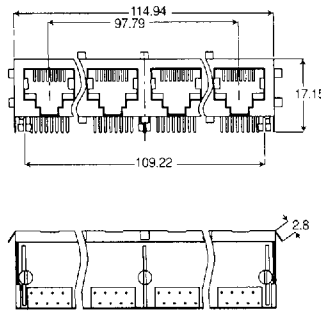

PHJ-8P8C-4A-P-5 Fully Shielded Panel Grounding Tabs

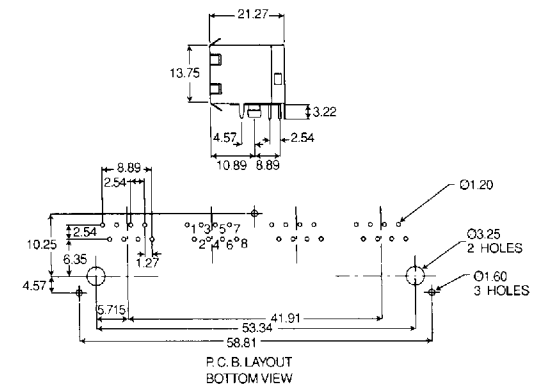
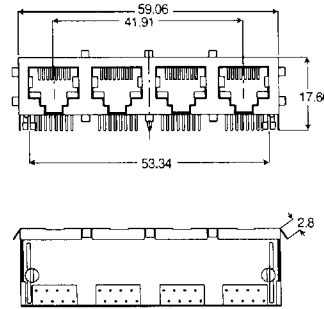
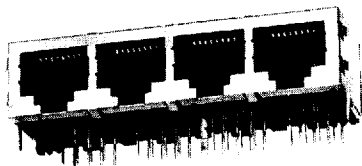

PHJ-8P8C-4T-P-5 Fully Shielded Panel Grounding Tabs

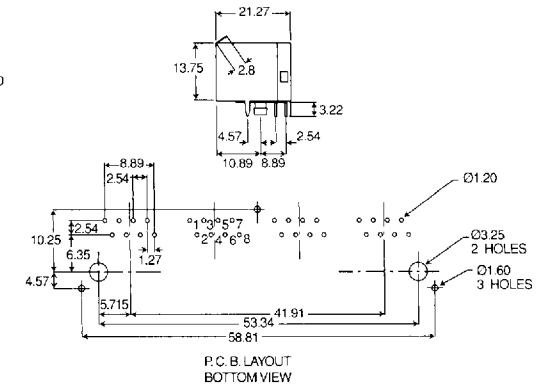
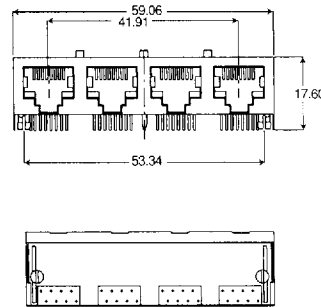
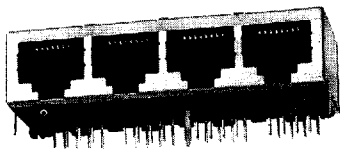

Specifications subject to change without notice. Dimensions in mm.



Right Angle

PHJ-6P4C-2-EG-5

(shown)

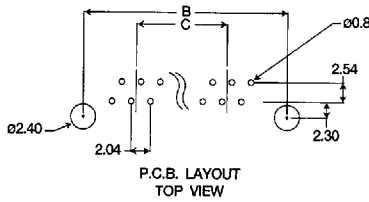
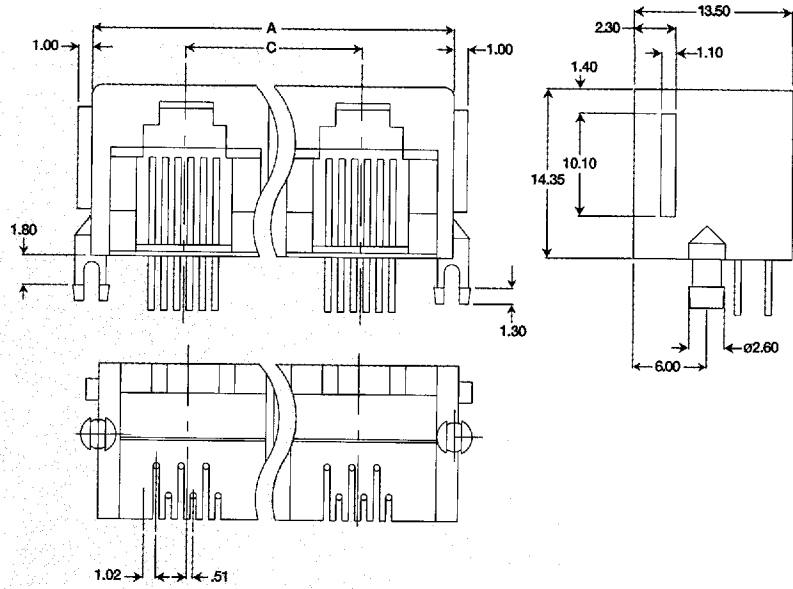
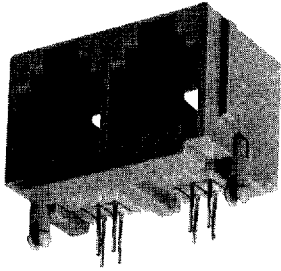

DIMENSIONS	NO. OF PORTS										
	2	3	4	5	6	7	8	9	10	11	12
A	23.3	34.3	45.3	56.3	67.3	78.3	89.3	100.3	111.3	122.3	133.3
B	23.0	34.0	45.0	56.0	67.0	78.0	89.0	100.0	111.0	122.0	133.0
C	11.0	22.0	33.0	44.0	55.0	66.0	77.0	88.0	99.0	110.0	121.0

PHJ-6P4C-3-RG-5

(shown)

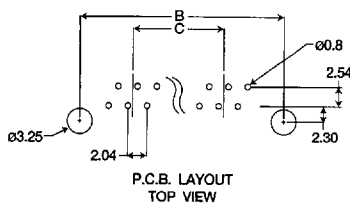
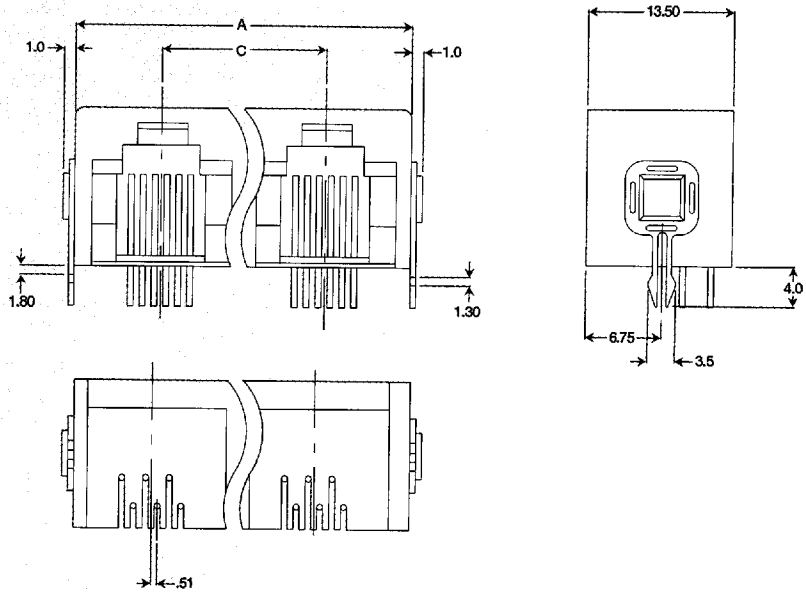
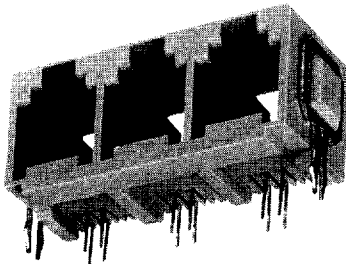

DIMENSIONS	NO. OF PORTS										
	2	3	4	5	6	7	8	9	10	11	12
A	23.3	34.3	45.3	56.3	67.3	78.3	89.3	100.9	111.3	122.3	133.3
B	23.0	34.5	45.5	56.5	67.5	78.5	89.5	100.5	111.5	122.5	133.5
C	11.0	22.0	33.0	44.0	55.0	66.00	77.0	88.0	99.0	110.0	121.0

Specifications subject to change without notice. Dimensions in mm.



59 Lakeside Avenue • West Orange, N.J. 07052-0539 • 201 736-5722 • FAX: 201 736-8930