



LM1576 and 2576HV

3 Amp Buck Voltage Regulator

Preliminary Information

General Description

The LM1576 series of monolithic integrated circuits provide all the active functions for a step-down (buck) switching regulator. Fixed versions are available with a 3.3V, 5V, 12V, or 15V fixed output. Adjustable versions have an output voltage range from 1.23V to 37V (57V for the high voltage version). Both versions are capable of driving a 3A load with excellent line and load regulation.

These regulators are simple to use because they require a minimum number of external components and include internal frequency compensation and a fixed-frequency oscillator.

The LM1576 series offers a high efficiency replacement for popular three-terminal adjustable linear regulators. It substantially reduces the size of the heat sink, and in many cases no heat sink is required.

A standard series of inductors available from several different manufacturers are ideal for use with the LM1576 series. This feature greatly simplifies the design of switch-mode power supplies.

The feedback voltage is guaranteed to $\pm 2\%$ tolerance for adjustable versions, and the output voltage is guaranteed to $\pm 3\%$ for fixed versions, within specified input voltages and output load conditions. The oscillator frequency is guaranteed to $\pm 10\%$. External shutdown is included, featuring less than 200 μ A standby current. The output switch includes cycle-by-cycle current limiting and thermal shutdown for full protection

Features

- 3.3V, 5V, 12V, 15V, and adjustable output versions
- Voltage over specified line and load conditions:
Fixed version: $\pm 3\%$ max. output voltage
Adjustable version: $\pm 2\%$ max. feedback voltage
- Guaranteed 1A output current
- Wide input voltage range:
4V to 40V
4V to 60V for HV versions
- Wide output voltage range
1.23V to 37V
1.23V to 57V for HV versions
- Requires only 4 external components
- 52kHz fixed frequency internal oscillator
- Low power standby mode I_Q typically < 200 μ A
- 80% efficiency (adjustable version typically > 80%)
- Uses readily available standard inductors
- Thermal shutdown and current limit protection
- 100% electrical thermal limit burn-in

Applications

- Simple high-efficiency step-down (buck) regulator
- Efficient pre-regulator for linear regulators
- On-card switching regulators
- Positive to negative converter (inverting Buck-Boost)
- Isolated Flyback Converter using minimum number of external components
- Negative Boost Converter

Typical Applications

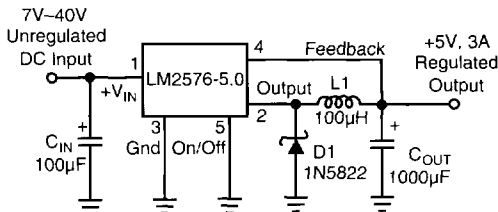

Note: Pin numbers are for TO-220 Package

Fixed Regulator in Typical Application

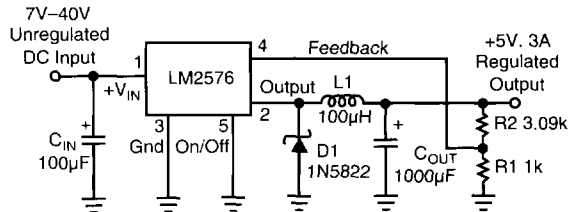

Note: Pin numbers are for TO-220 Package

$$V_{OUT} = 1.23 \left(1 + \frac{R_2}{R_1} \right)$$

Adjustable Regulator in Fixed Output Application

Ordering Information

Part Number [‡]	Temperature Range	Package
LM1576AK*	-55°C to +125°C	4-pin TO-3
LM1576-3.3AK	-55°C to +125°C	4-pin TO-3
LM1576-5.0AK	-55°C to +125°C	4-pin TO-3
LM1576-12AK	-55°C to +125°C	4-pin TO-3
LM1576-15AK	-55°C to +125°C	4-pin TO-3
LM2576BT**	-40°C to +85°C	5-lead TO-220
LM2576-3.3BT†	-40°C to +85°C	5-lead TO-220
LM2576-5.0BT†	-40°C to +85°C	5-lead TO-220
LM2576-12BT†	-40°C to +85°C	5-lead TO-220
LM2576-15BT†	-40°C to +85°C	5-lead TO-220
LM2576BU*	-40°C to +85°C	5-lead TO-263
LM2576-3.3BU	-40°C to +85°C	5-lead TO-263
LM2576-5.0BU	-40°C to +85°C	5-lead TO-263
LM2576-12BU	-40°C to +85°C	5-lead TO-263
LM2576-15BU	-40°C to +85°C	5-lead TO-263
LM1576HVAK*	-55°C to +125°C	4-pin TO-3
LM1576HV-3.3AK	-55°C to +125°C	4-pin TO-3
LM1576HV-5.0AK	-55°C to +125°C	4-pin TO-3
LM1576HV-12AK	-55°C to +125°C	4-pin TO-3
LM1576HV-15AK	-55°C to +125°C	4-pin TO-3
LM2576HVBT*†	-40°C to +85°C	5-lead TO-220
LM2576HV-3.3BT†	-40°C to +85°C	5-lead TO-220
LM2576HV-5.0BT†	-40°C to +85°C	5-lead TO-220
LM2576HV-12BT†	-40°C to +85°C	5-lead TO-220
LM2576HV-15BT†	-40°C to +85°C	5-lead TO-220
LM2576HVBU*	-40°C to +85°C	5-lead TO-263
LM2576HV-3.3BU	-40°C to +85°C	5-lead TO-263
LM2576HV-5.0BU	-40°C to +85°C	5-lead TO-263
LM2576HV-12BU	-40°C to +85°C	5-lead TO-263
LM2576HV-15BU	-40°C to +85°C	5-lead TO-263

* Adjustable output regulators.

† Contact factory for bent or staggered leads option.

‡ HV (high voltage) version available mid-1993.

Pin Configurations

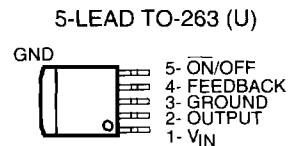
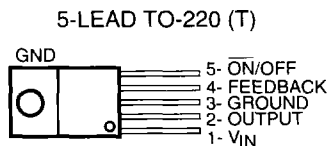
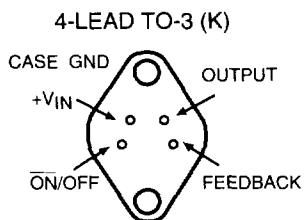

Absolute Maximum Ratings (Note 1)

Maximum Supply Voltage		
LM1576/LM2576		45V
LM2576HV		63V
ON/OFF Pin Input Voltage	$-0.3V \leq V \leq +40V$	
Output Voltage to Ground (Steady State)		-1V
Power Dissipation		Internally Limited
Storage Temperature Range		-65°C to $+150^{\circ}\text{C}$
Minimum ESD Rating		
C = 100pF, R = 1.5k Ω		2 kV
FB Pin		1 kV
Lead Temperature (soldering, 10 sec.)		260 $^{\circ}\text{C}$

Operating Ratings

Maximum Junction Temperature		150 $^{\circ}\text{C}$
Temperature Range		
LM1576		$-55^{\circ}\text{C} \leq T_J \leq +150^{\circ}\text{C}$
LM2576/2576HV		$-40^{\circ}\text{C} \leq T_J \leq +125^{\circ}\text{C}$
Supply Voltage		
LM1576/2576		40V
LM2576HV		60V

Electrical Characteristics Specifications with standard typeface are for $T_J = 25^{\circ}\text{C}$, and those with **boldface type** apply over full Operating Temperature Range. Unless otherwise specified, $V_{IN} = 12V$, and $I_{LOAD} = 500\text{mA}$.

Symbol	Parameter	Conditions	Typ	LM1576	LM2576/HV	Units (Limits)
				Limit (Note 2)	Limit (Note 3)	
SYSTEM PARAMETERS, ADJUSTABLE REGULATORS (Note 4) Test Circuit Figure 1						
V_{OUT}	Feedback Voltage	$V_{IN} = 12V$, $I_{LOAD} = 0.5A$ $V_{OUT} = 5V$	1.230	1.217 1.243	1.217 1.243	V V(min) V(max)
V_{OUT}	Feedback Voltage LM1576/2576	$0.5A \leq I_{LOAD} \leq 1A$, $8V \leq V_{IN} \leq 40V$ $V_{OUT} = 5V$	1.230	1.205/ 1.193 1.255/ 1.267	1.193/ 1.180 1.267/ 1.280	V V(min) V(max)
V_{OUT}	Feedback Voltage LM2576HV	$0.5A \leq I_{LOAD} \leq 1A$, $8V \leq V_{IN} \leq 60V$ $V_{OUT} = 5V$	1.230		1.193/ 1.180 1.273/ 1.286	V V(min) V(max)
η	Efficiency	$V_{IN} = 12V$, $I_{LOAD} = 1A$, $V_{OUT} = 5V$	82			%
SYSTEM PARAMETERS, 3.3V REGULATORS (Note 4) Test Circuit Figure 1						
V_{OUT}	Output Voltage	$V_{IN} = 12V$, $I_{LOAD} = 0.5A$ $V_{OUT} = 3.3V$	3.3	3.267 3.333	3.234 3.366	V V(min) V(max)
V_{OUT}	Output Voltage LM1576-3.3/2576-3.3	$0.5A \leq I_{LOAD} \leq 1A$, $8V \leq V_{IN} \leq 40V$ $V_{OUT} = 3.3V$	3.3	3.201/ 3.168 3.399/ 3.432	3.168/ 3.135 3.432/ 3.465	V V(min) V(max)
V_{OUT}	Output Voltage LM2576HV-3.3	$0.5A \leq I_{LOAD} \leq 1A$, $8V \leq V_{IN} \leq 60V$ $V_{OUT} = 3.3V$	3.3		3.168/ 3.135 3.449/ 3.482	V V(min) V(max)
η	Efficiency	$V_{IN} = 12V$, $I_{LOAD} = 1A$	75			%
SYSTEM PARAMETERS, 5V REGULATORS (Note 4) Test Circuit Figure 1						
V_{OUT}	Output Voltage	$V_{IN} = 12V$, $I_{LOAD} = 0.5A$ $V_{OUT} = 5V$	5.0	4.950 5.050	4.900 5.100	V V(min) V(max)
V_{OUT}	Output Voltage LM1576-5.0/2576-5.0	$0.5A \leq I_{LOAD} \leq 1A$, $8V \leq V_{IN} \leq 40V$ $V_{OUT} = 5V$	5.0	4.850/ 4.800 5.150/ 5.200	4.800/ 4.750 5.200/ 5.250	V V(min) V(max)
V_{OUT}	Output Voltage LM2576HV-5.0	$0.5A \leq I_{LOAD} \leq 1A$, $8V \leq V_{IN} \leq 60V$ $V_{OUT} = 5V$	5.0		4.800/ 4.750 5.225/ 5.275	V V(min) V(max)
η	Efficiency	$V_{IN} = 12V$, $I_{LOAD} = 3A$	82			%

Electrical Characteristics (continued)

Symbol	Parameter	Conditions	Typ	LM1576	LM2576/HV	Units (Limits)
				Limit (Note 2)	Limit (Note 3)	
SYSTEM PARAMETERS, 12V REGULATORS (Note 4) Test Circuit <i>Figure 1</i>						
V_{OUT}	Output Voltage	$V_{IN} = 25V, I_{LOAD} = 0.5A$ $V_{OUT} = 12V$	12	11.880 12.120	11.760 12.240	V V(min) V(max)
V_{OUT}	Output Voltage LM1576-12/LM2576-12	$0.5A \leq I_{LOAD} \leq 1A, 15V \leq V_{IN} \leq 40V$ $V_{OUT} = 12V$	12	11.640/11.520 12.360/12.480	11.520/11.400 12.480/12.600	V V(min) V(max)
V_{OUT}	Output Voltage LM2576HV-12	$0.5A \leq I_{LOAD} \leq 1A, 15V \leq V_{IN} \leq 60V$ $V_{OUT} = 12V$	12		11.520/11.400 12.540/12.660	V V(min) V(max)
η	Efficiency	$V_{IN} = 25V, I_{LOAD} = 1A$	88			%
SYSTEM PARAMETERS, 15V REGULATORS (Note 4) Test Circuit <i>Figure 1</i>						
V_{OUT}	Output Voltage	$V_{IN} = 30V, I_{LOAD} = 0.5A$ $V_{OUT} = 15V$	15	14.850 15.150	14.700 15.300	V V(min) V(max)
V_{OUT}	Output Voltage LM1576-15/2576-15	$0.5A \leq I_{LOAD} \leq 1A, 18V \leq V_{IN} \leq 40V$ $V_{OUT} = 15V$	15	14.550/14.400 15.450/15.600	14.400/14.250 15.600/15.750	V V(min) V(max)
V_{OUT}	Output Voltage LM2576HV-15	$0.5A \leq I_{LOAD} \leq 1A, 18V \leq V_{IN} \leq 60V$ $V_{OUT} = 15V$	15		14.400/14.250 15.675/15.825	V V(min) V(max)
η	Efficiency	$V_{IN} = 30V, I_{LOAD} = 3A$	88			%
DEVICE PARAMETERS, ADJUSTABLE REGULATOR						
I_B	Feedback Bias Current	$V_{OUT} = 5V$	50	100/500	100/500	nA
DEVICE PARAMETERS, FIXED and ADJUSTABLE REGULATORS						
f_O	Oscillator Frequency	(Note 11)	52	47/43 58/62	47/42 58/63	kHz kHz (min) kHz (max)
V_{SAT}	Saturation Voltage	$I_{OUT} = 3A$ (Note 5)	1.4	1.8/2.0	1.8/2.0	V V(max)
DC	Max Duty Cycle (ON)	(Note 6)	98	93	93	% %(min)
I_{CL}	Current Limit	Peak Current, $t_{ON} \leq 3\mu S$ (Note 5)	5.8	4.2/3.5 6.9/7.5	4.2/3.5 6.9/7.5	A A(min) A(max)
I_L	Output Leakage Current	$V_{IN} = 40V$, (Note 7), $V_{IN} = 60V$ for HV (Note 7)	7.5	2 30	2 30	mA(max) mA mA(max)
I_Q	Quiescent Current	(Note 7)	5	10/12	10	mA mA(max)
I_{STBY}	Standby Quiescent Current	ON/OFF Pin = 5V (OFF)	50	200/500	200	μA μA (max)
θ_{JA} θ_{JC} θ_{JA} θ_{JA} θ_{JC}	Thermal Resistance	K Package, Junction to Ambient K Package, Junction to Case T,U Package, Junction to Ambient (Note 8) T,U Package, Junction to Ambient (Note 9) T,U Package, Junction to Case	35 1.5 65 45 2			$^{\circ}C/W$

Electrical Characteristics (continued)

Symbol	Parameter	Conditions	Typ	LM1576	LM2576/HV	Units (Limits)
				Limit (Note 2)	Limit (Note 3)	
ON/OFF CONTROL, FIXED and ADJUSTABLE REGULATORS Test Circuit Figure 1						
V_{IH} V_{IL}	ON/OFF Pin Logic Input Level	$V_{OUT} = 0V$ $V_{OUT} = 5V$	1.4 1.2	2.2/2.4 1.0/0.8	2.2/2.4 1.0/0.8	V(min) V(max)
I_{IH}	ON /OFF Pin Logic Current	ON /OFF Pin = 5V (OFF)	4	30	30	μA $\mu A(max)$
I_{IL}		ON/OFF Pin = 0V (ON)	0.01	10	10	μA $\mu A(max)$

- Note 1:** Absolute Maximum Rating indicate limits beyond which damage to the device may occur. Operating Ratings indicate conditions for which the device is intended to be functional, but do not guarantee specific performance limits. For guaranteed specifications and test conditions, see the Electrical Characteristics.
- Note 2:** All limits guaranteed at room temperature (standard type face) and at **temperature extremes (bold type face)**. All limits are used to calculate Average Outgoing Quality level, and all are 100% production tested.
- Note 3:** All limits guaranteed at room temperature (standard type face) and at **temperature extremes (bold type face)**. All room temperature limits are 100% production tested. All limits at **temperature extreme** are guaranteed via testing.
- Note 4:** External components such as the catch diode, inductor, input and output capacitors can affect switching regulator system performance. When the LM1576/LM2576 is used as shown in Figure 1 test circuit, system performance will be shown in system parameters section of Electrical Characteristics.
- Note 5:** Output (pin 2) sourcing current. No diode, inductor or capacitor connected to output.
- Note 6:** Feedback (pin 4) removed from output and connected to 0V.
- Note 7:** Feedback (pin 4) removed from output and connected to 12V to force the output transistor OFF.
- Note 8:** Junction to ambient thermal resistance (no external heat sink) for the 5-lead TO-220 package mounted vertically, with 1/2" leads in a socket, or on PC board with minimum copper area.
- Note 9:** Junction to ambient thermal resistance (no external heat sink) for the 5-lead TO-220 package mounted vertically, with 1/4" leads soldered to PC board containing approximately 4 square inches of copper area surrounding the leads.
- Note 10:** Junction to ambient thermal resistance with approximately 1 square inch of pc board copper surrounding the leads. Additional copper will lower thermal resistance further.
- Note 11:** The oscillator frequency reduces to approximately 18 kHz in the event of an output short or an overload which pulls the feedback voltage lower than 0.7V. This self-protection feature lowers the average power dissipation of the IC by reducing the minimum duty cycle from 5% to approximately 2%.

Typical Performance Characteristics

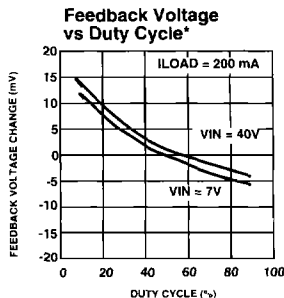
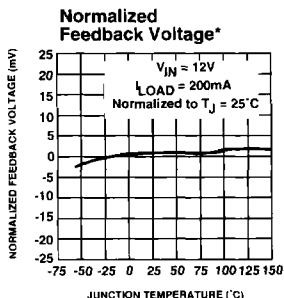

* Adjustable version only

Typical Performance Characteristics (continued) (Circuit of Figure 1)

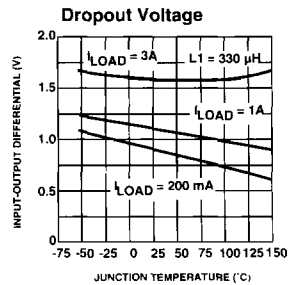
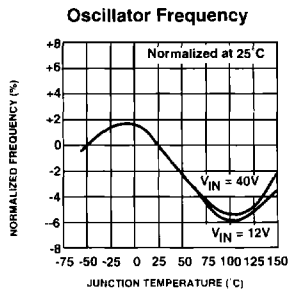
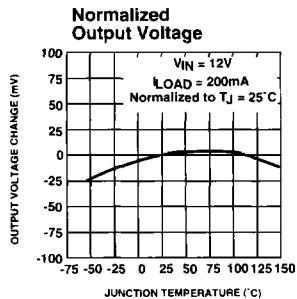
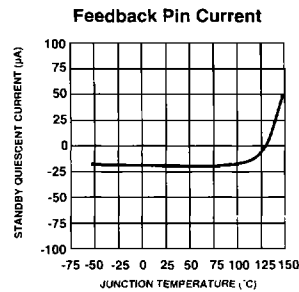
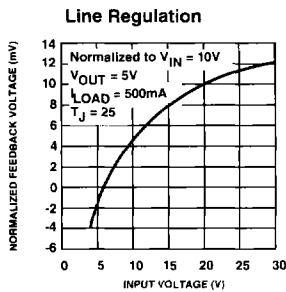
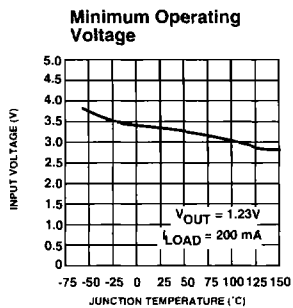
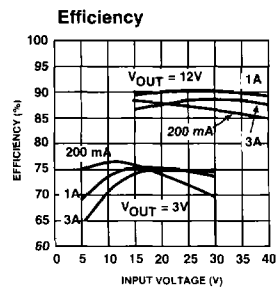
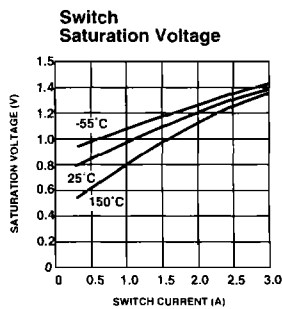
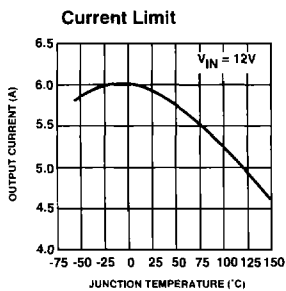
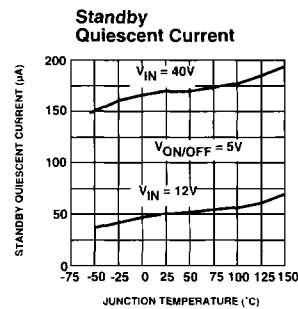
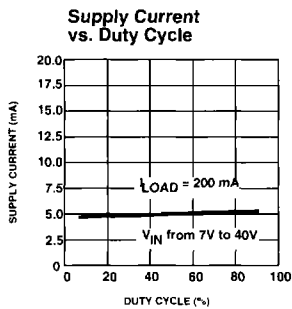
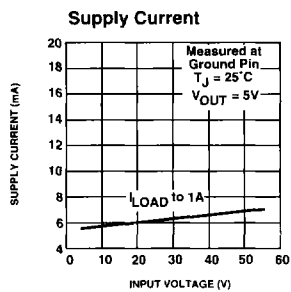

Typical Performance Characteristics (Circuit of Figure 1)

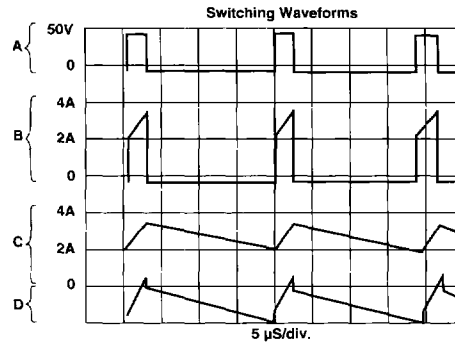
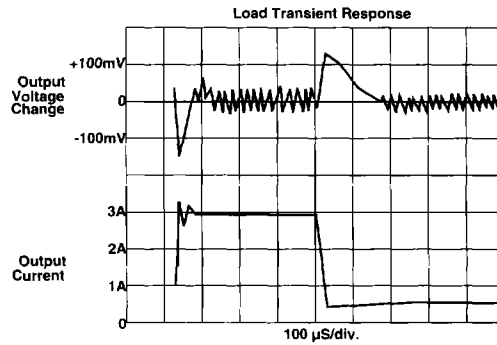

$V_{OUT} = 5V$ $V_{IN} = 45V$

A: Output pin voltage 50V/div
 B: Output pin current 2A/div
 C: Inductor current 2A/div
 D: Output ripple voltage 50 mV/div., AC coupled

Horizontal Time Base: 5 μ S/div

Test Circuits and Layout Guidelines

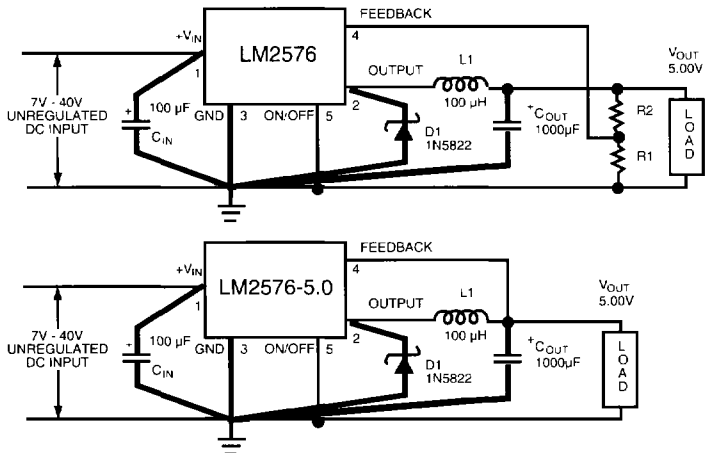

- C_{IN} — 100µF 75V Aluminum Electrolytic
- C_{OUT} — 1000µF, 15V Aluminum Electrolytic
- D1 — Schottky, 1N5822
- L1 — 100µH, PE-92108 (Pulse Engineering)
- R1 — 1k, 0.01%
- R2 — 3.065k, 0.01%
- 5-pin TO-220 socket—2936 (Loranger Mfg. Co.)
- 4-pin TO-3 socket—8112-AG7 (Augat Inc.)

- C_{IN} — 100µF 75V Aluminum Electrolytic
- C_{OUT} — 1000µF, 15V Aluminum Electrolytic
- D1 — Schottky, 1N5822
- L1 — 330µH, PE-92106 (Pulse Engineering)
- 5-pin TO-220 socket—2936 (Loranger Mfg. Co.)
- 4-pin TO-3 socket—8112-AG7 (Augat Inc.)

Note: Pin numbers are for TO-220 Package

Figure 1.

As in any switching regulator, layout is very important. Rapidly switching currents associated with wiring inductance generate voltage transients which can cause problems. For minimal stray inductance and ground loops, the length of the leads indicated by heavy lines should be kept as short as possible. Single-point grounding (as indicated) or ground plane construction should be used for best results.

Block Diagrams

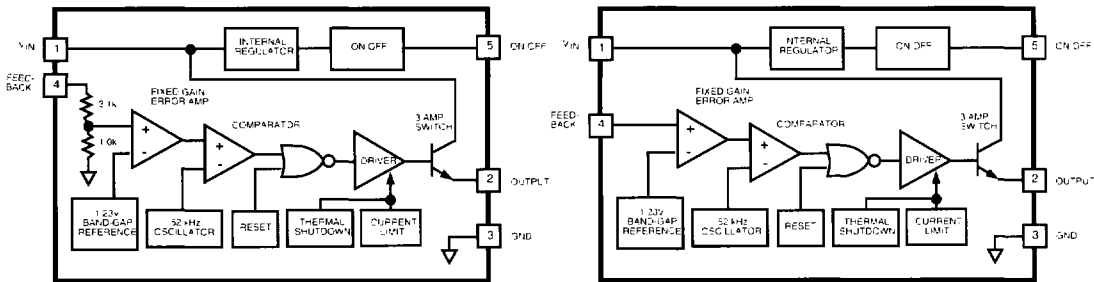

Note: Pin numbers are for the TO-220 package

Fixed Regulator

Adjustable Regulator