

# MSA-0711

## Cascadable Silicon Bipolar MMIC Amplifier



### Data Sheet

#### Description

The MSA-0711 is a low cost silicon bipolar Monolithic Microwave Integrated Circuit (MMIC) housed in the surface mount plastic SOT-143 package. This MMIC is designed for use as a general purpose 50  $\Omega$  gain block. Typical applications include narrow and broad band IF and RF amplifiers in commercial and industrial applications.

The MSA-series is fabricated using Avago's 10 GHz  $f_T$ , 25 GHz  $f_{MAX}$ , silicon bipolar MMIC process which uses nitride self-alignment, ion implantation, and gold metallization to achieve excellent performance, uniformity and reliability. The use of an external bias resistor for temperature and current stability also allows bias flexibility.

#### Features

- Cascadable 50  $\Omega$  Gain Block
- 3 dB Bandwidth: DC to 1.9 GHz
- 12.0 dB Typical Gain at 1.0 GHz
- Unconditionally Stable ( $k > 1$ )
- Low Cost Surface Mount Plastic Package
- Tape-and-Reel Packaging Option Available
- Lead-free Option Available

#### SOT-143 Package

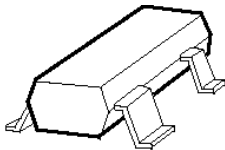

#### Pin Connections and Package Marking



#### Notes:

**Top View. Package Marking provides orientation and identification.**  
"x" is the date code.

#### Typical Biasing Configuration

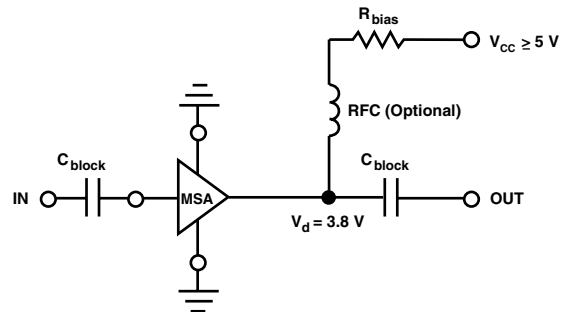

## MSA-0711 Absolute Maximum Ratings

Parameter	Absolute Maximum <sup>[1]</sup>
Device Current	50 mA
Power Dissipation <sup>[2,3]</sup>	175 mW
RF Input Power	+13 dBm
Junction Temperature	150°C
Storage Temperature	-65 to 150°C

<b>Thermal Resistance<sup>[2]</sup>:</b> $\theta_{jc} = 505^{\circ}\text{C}/\text{W}$
--

**Notes:**

1. Permanent damage may occur if any of these limits are exceeded.
2.  $T_{\text{CASE}} = 25^{\circ}\text{C}$ .
3. Derate at 2.0 mW/°C for  $T_{\text{C}} > 62^{\circ}\text{C}$ .

## Electrical Specifications<sup>[1]</sup>, $T_{\text{A}} = 25^{\circ}\text{C}$

Symbol	Parameters and Test Conditions: $I_{\text{d}} = 22 \text{ mA}$ , $Z_0 = 50 \Omega$	Units	Min.	Typ.	Max.
$G_{\text{p}}$	Power Gain ( $ S_{21} ^2$ ) f = 0.1 GHz f = 1.0 GHz	dB	10.0	13.0 12.0	
$\Delta G_{\text{p}}$	Gain Flatness f = 0.1 to 1.3 GHz	dB		$\pm 0.8$	
$f_{3 \text{ dB}}$	3 dB Bandwidth	GHz		3.2	
VSWR	Input VSWR f = 0.1 to 2.0 GHz			1.5:1	
	Output VSWR f = 0.1 to 2.0 GHz			1.5:1	
NF	50 $\Omega$ Noise Figure f = 1.0 GHz	dB		5.0	
$P_{1 \text{ dB}}$	Output Power at 1 dB Gain Compression f = 1.0 GHz	dBm		5.5	
$\text{IP}_3$	Third Order Intercept Point f = 1.0 GHz	dBm		18.0	
$t_{\text{D}}$	Group Delay f = 1.0 GHz	psec		145	
$V_{\text{d}}$	Device Voltage $T_{\text{C}} = 25^{\circ}\text{C}$	V	3.0	3.8	4.6
dV/dT	Device Voltage Temperature Coefficient	mV/°C		-7.0	

**Note:**

1. The recommended operating current range for this device is 15 to 30 mA. Typical performance as a function of current is on the following page.

## Ordering Information

Part Numbers	No. of Devices	Comments
MSA-0711-BLK	100	Bulk
MSA-0711-BLKG	100	Bulk
MSA-0711-TR1	3000	7" Reel
MSA-0711-TR1G	3000	7" Reel
MSA-0711-TR2	10000	13" Reel
MSA-0711-TR2G	10000	13" Reel

**Note:** Order part number with a "G" suffix if lead-free option is desired.

**MSA-0711 Typical Scattering Parameters ( $Z_0 = 50 \Omega$ ,  $T_A = 25^\circ\text{C}$ ,  $I_d = 22 \text{ mA}$ )**

Freq. GHz	$S_{11}$		$S_{21}$			$S_{12}$			$S_{22}$	
	Mag	Ang	dB	Mag	Ang	dB	Mag	Ang	Mag	Ang
0.1	.03	1	13.0	4.47	174	-18.6	.118	1	.19	-8
0.2	.04	1	12.9	4.42	168	-18.5	.119	2	.19	-18
0.4	.04	-4	12.8	4.38	157	-18.4	.120	4	.19	-36
0.6	.05	-19	12.6	4.28	146	-18.1	.125	9	.19	-52
0.8	.07	-32	12.3	4.14	135	-17.7	.130	10	.20	-68
1.0	.08	-44	12.0	3.99	123	-17.4	.135	12	.19	-82
1.5	.13	-88	10.9	3.52	98	-16.1	.157	13	.19	-113
2.0	.18	-130	9.8	3.08	75	-15.2	.173	8	.18	-138
2.5	.25	-155	8.6	2.68	61	-14.7	.184	9	.18	-151
3.0	.32	-178	7.2	2.30	42	-14.7	.185	5	.17	-158
3.5	.38	165	5.8	1.96	26	-14.8	.181	3	.17	-150
4.0	.42	152	4.5	1.68	12	-14.7	.184	1	.20	-142

**Typical Performance,  $T_A = 25^\circ\text{C}$**   
(unless otherwise noted)

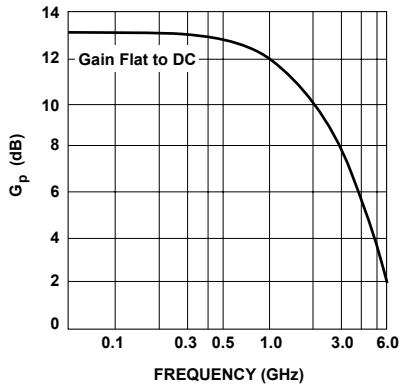

Figure 1. Power Gain vs. Frequency,  $I_d = 22 \text{ mA}$ .

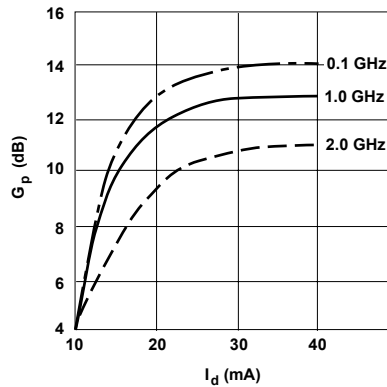

Figure 2. Power Gain vs. Current.

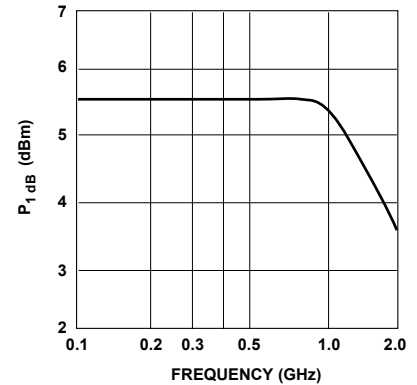

Figure 3. Output Power at 1 dB Gain Compression vs. Frequency,  $I_d = 22 \text{ mA}$ .

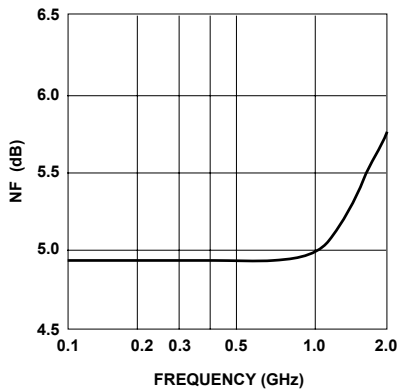
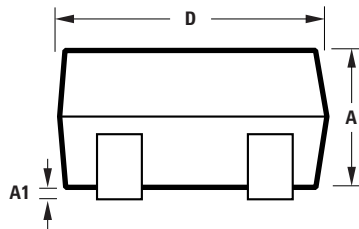
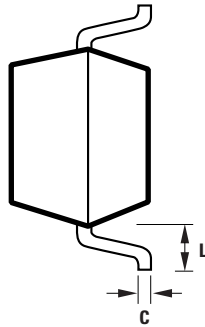
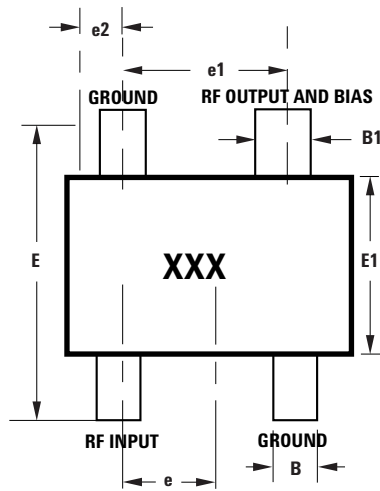

Figure 4. Noise Figure vs. Frequency,  $I_d = 22 \text{ mA}$ .

## SOT-143 Package Dimensions



Notes:  
 XXX-package marking  
 Drawings are not to scale

SYMBOL	DIMENSIONS (mm)	
	MIN.	MAX.
A	0.79	1.097
A1	0.013	0.10
B	0.36	0.54
B1	0.76	0.92
C	0.086	0.152
D	2.80	3.06
E1	1.20	1.40
e	0.89	1.02
e1	1.78	2.04
e2	0.45	0.60
E	2.10	2.65
L	0.45	0.69

For product information and a complete list of distributors, please go to our web site: [www.avagotech.com](http://www.avagotech.com)

Avago, Avago Technologies, and the A logo are trademarks of Avago Technologies, Limited in the United States and other countries. Data subject to change. Copyright © 2006 Avago Technologies, Limited. All rights reserved. Obsoletes 5989-4454EN AV02-0790EN - October 31, 2007

