

16-bit buffer/line driver (3-State)

74LVC16241A

FEATURES

- 5 volt tolerant inputs/outputs for interfacing with 5V logic
- Wide supply voltage range of 1.2V to 3.6V
- Complies with JEDEC standard no. 8-1A
- CMOS low power consumption
- MULTIBYTE™ flow-through standard pin-out architecture
- Low inductance multiple power and ground pins for minimum noise and ground bounce
- Direct interface with TTL levels

DESCRIPTION

The 74LVC16241A is a high-performance, low-power, low-voltage, Si-gate CMOS device, superior to most advanced CMOS compatible TTL families. Inputs can be driven from either 3.3V or 5V devices. In 3-State operation, outputs can handle 5V. These features allow the use of these devices in a mixed 3.3V/5V environment.

The 74LVC16241A is a 16-bit buffer/line driver with 3-State outputs. The 3-State outputs are controlled by the output enable inputs nOE and nOE. Schmitt-trigger action at all inputs makes the circuit highly tolerant for slower input rise and fall times. The device can be used as four 4-bit buffers, two 8-bit buffers or one 16-bit buffer.

PIN CONFIGURATION

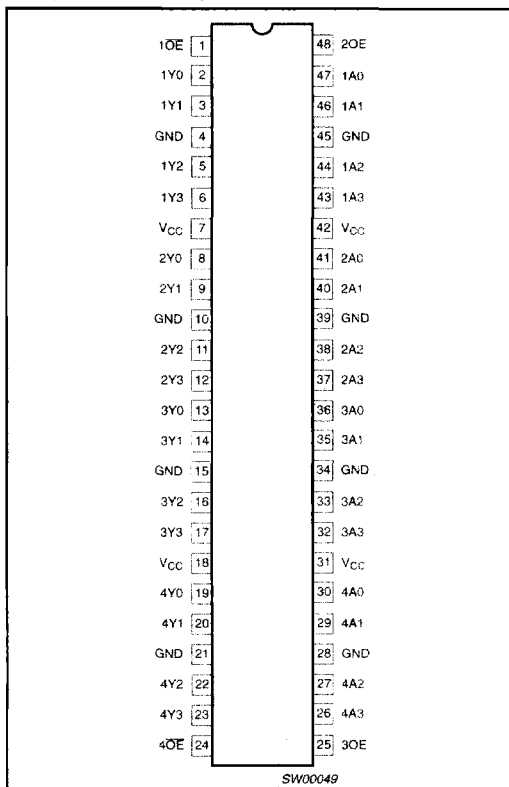

QUICK REFERENCE DATA

GND = 0 V; T_{amb} = 25 °C; t_r = t_f ≤ 2.5 ns

SYMBOL	PARAMETER	CONDITIONS	TYPICAL	UNIT
t _{PHL} /t _{PLH}	Propagation delay nAn to nYn	C _L = 50pF V _{CC} = 3.3V	2.9	ns
C _i	Input capacitance		5.0	pF
C _{PD}	Power dissipation capacitance per buffer	V _i = GND to V _{CC} ¹	25	pF

NOTES:

1. C_{PD} is used to determine the dynamic power dissipation (P_D in μW):

$$P_D = C_{PD} \times V_{CC}^2 \times f_i + \sum (C_L \times V_{CC}^2 \times f_o)$$
 where:
 f_i = input frequency in MHz; C_L = output load capacity in pF;
 f_o = output frequency in MHz; V_{CC} = supply voltage in V;
 ∑ (C_L × V_{CC}² × f_o) = sum of outputs.

ORDERING INFORMATION

PACKAGES	TEMPERATURE RANGE	OUTSIDE NORTH AMERICA	NORTH AMERICA	DWG NUMBER
48-Pin Plastic SSOP Type III	-40°C to +85°C	74LVC16241A DL	VC16241A DL	SOT370-1
48-Pin Plastic TSSOP Type II	-40°C to +85°C	74LVC16241A DGG	VC16241A DGG	SOT362-1

16-bit buffer/line driver (3-State)

74LVC16241A

PIN DESCRIPTION

PIN NUMBER	SYMBOL	NAME AND FUNCTION
1	1OE	Output enable input (active LOW)
2, 3, 5, 6	1Y0 to 1Y3	Data outputs
4, 10, 15, 21, 28, 34, 39, 45	GND	Ground (0V)
7, 18, 31, 42	VCC	Positive supply voltage
8, 9, 11, 12	2Y0 to 2Y3	Data outputs
13, 14, 16, 17	3Y0 to 3Y3	Data outputs
19, 20, 22, 23	4Y0 to 4Y3	Data outputs
24	4OE	Output enable input (active LOW)
25	3OE	Output enable input (active LOW)
30, 29, 27, 26	4A0 to 4A3	Data inputs
36, 35, 33, 32	3A0 to 3A3	Data inputs
41, 40, 38, 37	2A0 to 2A3	Data inputs
47, 46, 44, 43	1A0 to 1A3	Data inputs
48	2OE	Output enable input (active LOW)

LOGIC SYMBOL (IEEE/IEC)

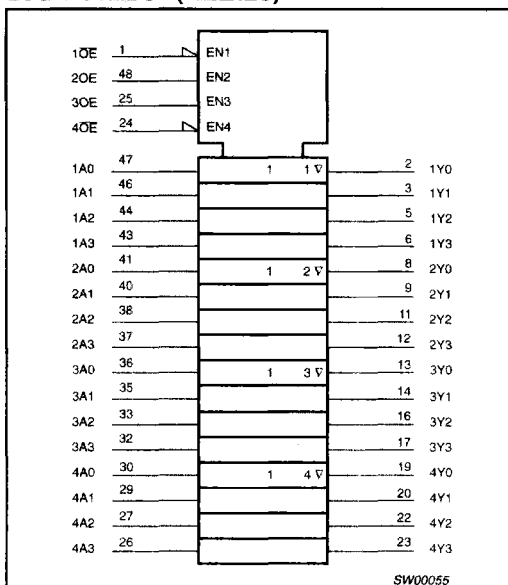

LOGIC SYMBOL

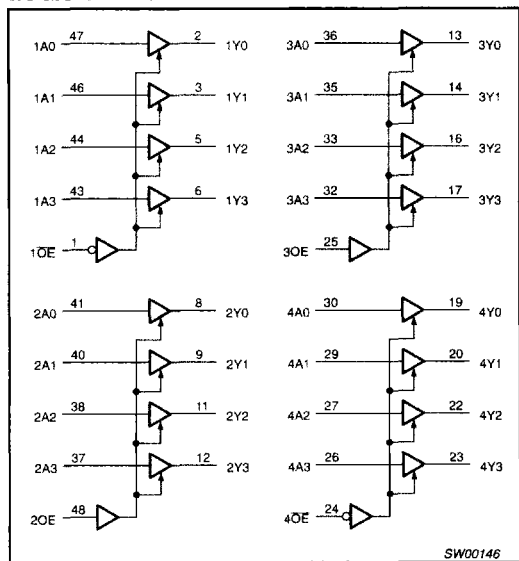

FUNCTION TABLES

INPUTS		OUTPUT
nOE	1An, 4An	1Yn, 4Yn
L	H	H
L	L	L
H	X	Z

INPUTS		OUTPUT
nOE	2An, 3An	2Yn, 3Yn
H	H	H
H	L	L
L	X	Z

H = HIGH voltage level
 L = LOW voltage level
 X = don't care
 Z = high impedance OFF-state

16-bit buffer/line driver (3-State)

74LVC16241A

RECOMMENDED OPERATING CONDITIONS

SYMBOL	PARAMETER	CONDITIONS	LIMITS		UNIT
			MIN.	MAX.	
V_{CC}	DC supply voltage (for max. speed performance)		2.7	3.6	V
V_{CC}	DC supply voltage (for low-voltage applications)		1.2	3.6	V
V_I	DC Input voltage range		0	5.5	V
V_O	DC output voltage range; output HIGH or LOW state		0	V_{CC}	V
V_O	DC output voltage range; output 3-State		0	5.5	V
T_{amb}	Operating ambient temperature range in free air	See DC and AC characteristics for individual device	-40	+85	°C
t_r, t_f	Input rise and fall times	$V_{CC} = 1.2$ to $2.7V$ $V_{CC} = 2.7$ to $3.6V$	0 0	20 10	ns/V

ABSOLUTE MAXIMUM RATINGS¹

In accordance with the Absolute Maximum Rating System (IEC 134) Voltages are referenced to GND (ground = 0V)

SYMBOL	PARAMETER	CONDITIONS	LIMITS		UNIT
			MIN	MAX	
V_{CC}	DC supply voltage		-0.5	+6.5	V
I_{IK}	DC input diode current	$V_I < 0$	-	-50	mA
V_I	DC input voltage	Note 2	-0.5	+6.5	V
I_{OK}	DC output diode current	$V_O > V_{CC}$ or $V_O < 0$	-	± 50	mA
V_O	DC output voltage; output HIGH or LOW state	Note 2	-0.5	$V_{CC} + 0.5$	V
V_O	DC output voltage; output 3-State	Note 2	-0.5	6.5	V
I_O	DC output source or sink current	$V_O = 0$ to V_{CC}	-	± 100	mA
I_{GND}, I_{CC}	DC V_{CC} or GND current		-	± 100	mA
T_{stg}	Storage temperature range		-65	+150	°C
P_{tot}	Power dissipation per package - SO package - SSOP and TSSOP package	Above +70°C derate linearly 8mW/K Above +60°C derate linearly 5.5mW/K		500 500	mW

NOTES:

- Stresses beyond those listed may cause permanent damage to the device. These are stress ratings only and functional operation of the device at these or any other conditions beyond those indicated under "recommended operating conditions" is not implied. Exposure to absolute-maximum-rated conditions for extended periods may affect device reliability.
- The input and output voltage ratings may be exceeded if the input and output clamp current ratings are observed.

16-bit buffer/line driver (3-State)

74LVC16241A

DC ELECTRICAL CHARACTERISTICS

Over recommended operating conditions. Voltages are referenced to GND (ground = 0V)

SYMBOL	PARAMETER	TEST CONDITIONS	LIMITS			UNIT
			Temp = -40°C to +85°C			
			MIN	TYP ¹	MAX	
V _{IH}	HIGH level Input voltage	V _{CC} = 1.2V	V _{CC}			V
		V _{CC} = 2.7 to 3.6V	2.0			
V _{IL}	LOW level Input voltage	V _{CC} = 1.2V			GND	V
		V _{CC} = 2.7 to 3.6V			0.8	
V _{OH}	HIGH level output voltage	V _{CC} = 2.7V; V _I = V _{IH} or V _{IL} ; I _O = -12mA	V _{CC} - 0.5			V
		V _{CC} = 3.0V; V _I = V _{IH} or V _{IL} ; I _O = -100μA	V _{CC} - 0.2	V _{CC}		
		V _{CC} = 3.0V; V _I = V _{IH} or V _{IL} ; I _O = -18mA	V _{CC} - 0.6			
		V _{CC} = 3.0V; V _I = V _{IH} or V _{IL} ; I _O = -24mA	V _{CC} - 0.8			
V _{OL}	LOW level output voltage	V _{CC} = 2.7V; V _I = V _{IH} or V _{IL} ; I _O = 12mA			0.40	V
		V _{CC} = 3.0V; V _I = V _{IH} or V _{IL} ; I _O = 100μA		GND	0.20	
		V _{CC} = 3.0V; V _I = V _{IH} or V _{IL} ; I _O = 24mA			0.55	
I _I	Input leakage current	V _{CC} = 3.6V; V _I = 5.5V or GND		±0.1	±5	μA
I _{OZ}	3-State output OFF-state current	V _{CC} = 3.6V; V _I = V _{IH} or V _{IL} ; V _O = 5.5V or GND		0.1	±5	μA
I _{off}	Power off leakage supply	V _{CC} = 0.0V; V _I or V _O = 5.5V		0.1	±10	μA
I _{CC}	Quiescent supply current	V _{CC} = 3.6V; V _I = V _{CC} or GND; I _O = 0		0.1	20	μA
ΔI _{CC}	Additional quiescent supply current per input pin	V _{CC} = 2.7V to 3.6V; V _I = V _{CC} - 0.6V; I _O = 0		5	500	μA

NOTE:1. All typical values are at V_{CC} = 3.3V and T_{amb} = 25°C.**AC CHARACTERISTICS**GND = 0V; t_R = t_F = 2.5ns; C_L = 50pF; R_L = 500Ω; T_{amb} = -40°C to +85°C.

SYMBOL	PARAMETER	WAVEFORM	LIMITS					LIMITS V _{CC} = 1.2V	UNIT
			V _{CC} = 3.3V ±0.3V			V _{CC} = 2.7V			
			MIN	TYP ¹	MAX	MIN	MAX		
t _{PHL} t _{PLH}	Propagation delay nAn to nYn; nAn to nYn	1, 4	1.5	2.9	4.4	1.5	5.4	13	ns
t _{PZH} t _{PZL}	3-State output enable time 1OE to 1Yn; 4OE to 4Yn	3, 4	1.5	4.4	5.8	1.5	6.8	17	ns
t _{PHZ} t _{PLZ}	3-State output disable time 1OE to 1Yn; 4OE to 4Yn	3, 4	1.5	4.3	5.8	1.5	6.8	11	ns
t _{PZH} t _{PZL}	3-State output enable time 2OE to 2Yn; 3OE to 3Yn	2, 4	1.5	4.4	5.5	1.5	6.5	19	ns
t _{PHZ} t _{PLZ}	3-State output disable time 2OE to 2Yn; 3OE to 3Yn	2, 4	1.5	4.9	5.4	1.5	6.4	12	ns

NOTE:1. All typical values are at V_{CC} = 3.3V and T_{amb} = 25°C.

16-bit buffer/line driver (3-State)

74LVC16241A

AC WAVEFORMS

$V_M = 1.5V$ at $V_{CC} \geq 2.7V$; $V_M = 0.5 V_{CC}$ at $V_{CC} < 2.7V$.
 V_{OL} and V_{OH} are the typical output voltage drop that occur with the output load.
 $V_X = V_{OL} + 0.3V$ at $V_{CC} \geq 2.7V$; $V_X = V_{OL} + 0.1 V_{CC}$ at $V_{CC} < 2.7V$
 $V_Y = V_{OH} - 0.3V$ at $V_{CC} \geq 2.7V$; $V_Y = V_{OH} - 0.1 V_{CC}$ at $V_{CC} < 2.7V$

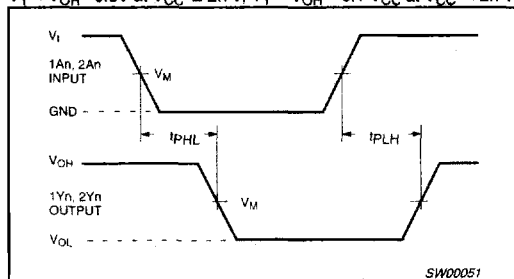

Waveform 1. Input (nAn) to output (nYn) propagation times

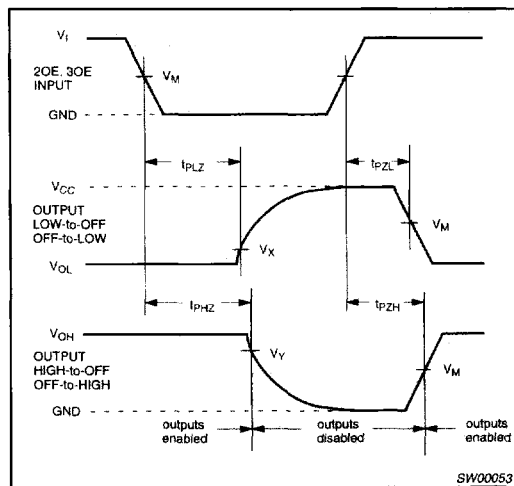

Waveform 2. 3-State enable and disable times for the input (20E, 30E)

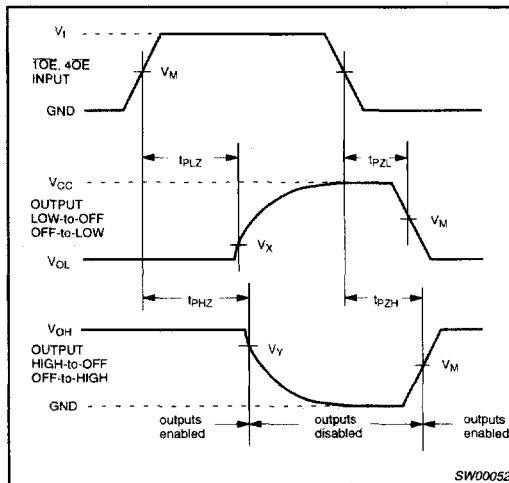

Waveform 3. 3-State enable and disable times for the input (10E, 40E)

TEST CIRCUIT

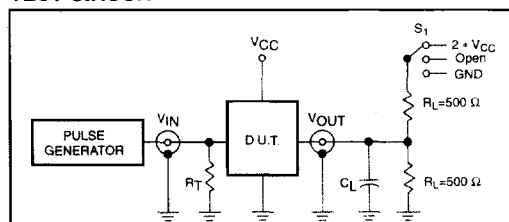

Test Circuit for 3-State Outputs

SWITCH POSITION

TEST	SWITCH
t_{PLH}/t_{PHL}	Open
t_{PLZ}/t_{PZL}	$2 \times V_{CC}$
t_{PHZ}/t_{PZH}	GND

V_{CC}	V_{IN}
$< 2.7V$	V_{CC}
$2.7 - 3.6V$	$2.7V$

DEFINITIONS

R_L = Load resistor
 C_L = Load capacitance includes jig and probe capacitance
 R_T = Termination resistance should be equal to Z_{OUT} of pulse generators.

SW00047

Waveform 4. Load circuitry for switching times