

ICL76XX

High Reliability ICL76XX Series Low Power CMOS Operational Amplifiers

2

GENERAL DESCRIPTION

The ICL761X/762X/764X series is a family of monolithic CMOS operational amplifiers. These devices provide the designer with high performance operation at low supply voltages and selectable quiescent currents, and are an ideal design tool when ultra low input current and low power dissipation are desired.

The basic amplifier will operate at supply voltages ranging from $\pm 1V$ to $\pm 8V$, and may be operated from a single Lithium cell.

A unique quiescent current programming pin allows setting of standby current to 1mA, 100 μ A, or 10 μ A, with no external components. This results in power consumption as low as 20 μ W. Output swings range to within a few millivolts of the supply voltages.

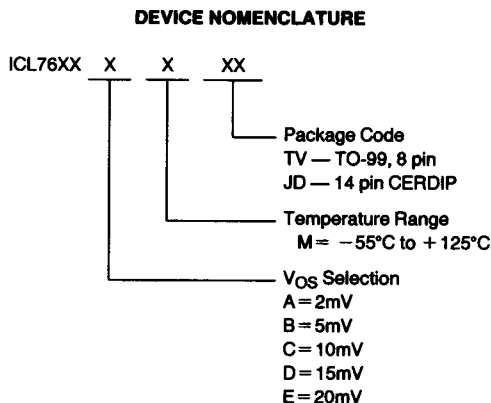
Of particular significance is the extremely low (1pA) input current, input noise current of .01pA/ $\sqrt{\text{Hz}}$, and $10^{12}\Omega$ input impedance. These features optimize performance in very high source impedance applications.

The inputs are internally protected and require no special handling procedures. Outputs are fully protected against short circuits to ground or to either supply.

AC performance is excellent, with a slew rate of 1.6V/ μ s, and unity gain bandwidth of 1MHz at $I_Q = 1\text{mA}$.

Because of the low power dissipation, operating temperatures and drift are quite low. Applications utilizing these features may include stable instruments, extended life designs, or high density packages.

SELECTION GUIDE



FEATURES

- Wide Operating Voltage Range $\pm 1V$ to $\pm 8V$
- High Input Impedance — $10^{12}\Omega$
- Programmable Power Consumption — Low As 20 μ W
- Input Current Lower Than BIFETs — Typ 1pA
- Available As Singles, Duals, and Quads
- Output Voltage Swings to Within Millivolts Of V^- and V^+
- Low Power Replacement for Many Standard Op Amps
- Compensated and Uncompensated Versions
- Input Common Mode Voltage Range Greater Than Supply Rails (ICL7612)

APPLICATIONS

- Portable Instruments
- Telephone Headsets
- Hearing Aid/Microphone Amplifiers
- Meter Amplifiers
- Medical Instruments
- High Impedance Buffers

SPECIAL FEATURE CODES

- | | | |
|---|---|--|
| C | = | INTERNALLY COMPENSATED |
| H | = | HIGH QUIESCENT CURRENT (1mA) |
| L | = | LOW QUIESCENT CURRENT (10 μ A) |
| M | = | MEDIUM QUIESCENT CURRENT (100 μ A) |
| O | = | OFFSET NULL CAPABILITY |
| P | = | PROGRAMMABLE QUIESCENT CURRENT |
| V | = | EXTENDED CMVR |

ICL76XX

ORDERING INFORMATION

Basic Part Number	Number of OP-AMPS in Package, and Special Features (SEE CODES)	Package Type and Suffix	
		8-Lead TO-99	Ceramic DIP (1)
		-55°C to +125°C	-55°C to +125°C
ICL7611 ICL7612	SINGLE OP-AMP: C, O, P C, O, P, V	AMTV BMTV DMTV	
ICL7621	DUAL OP-AMP: C, M	AMTV BMTV DMTV	
ICL7641 ICL7642	QUAD OP-AMP: C, H C, L		CMJD EMJD

NOTES: 1. Duals and quads are available in 14 pin DIP package.
 2. Ordering code must consist of basic part number and package suffix, e.g., ICL7611BCPA.

Device	Description	Pin Assignments
ICL7611XMTV ICL7612XMTV	Internal compensation, plus offset null capability and external I_Q control	<p>TO-99 (TOP VIEW) (outline dwg TV)</p> <p>Diagram showing pin assignments for TO-99 (TOP VIEW):</p> <ul style="list-style-type: none"> Pin 1: OFFSET Pin 2: -IN Pin 3: +IN Pin 4: V^- Pin 5: OFFSET Pin 6: OUTPUT Pin 7: V^+ Pin 8: I_Q SET <p>0131-1</p>

Figure 1: Pin Configurations

ICL76XX

2

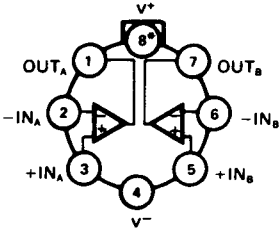
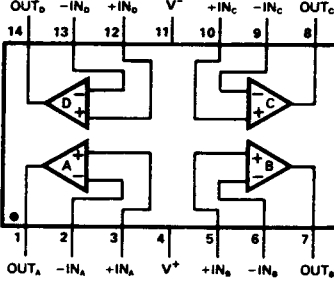
Device	Description	Pin Assignments
<p>ICL7621XMTV</p>	<p>Dual op amps with internal compensation; I_Q fixed at $100\mu\text{A}$ Pin compatible with Texas Inst. TL082 Motorola MC1458 Raytheon RC4558</p>	<p>TO-99 (TOP VIEW) (outline dwg TV)</p>  <p style="text-align: right;">0131-2</p> <p>*Pin 8 connected to case.</p>
<p>ICL7641XMJD ICL7642XMJD</p>	<p>Quad op amps with internal compensation. I_Q fixed at 1mA (ICL7641) I_Q fixed at $10\mu\text{A}$ (ICL7642) Pin compatible with Texas Instr. TL084 National LM324 Harris HA4741</p>	<p>14 PIN DIP (TOP VIEW) (outline dwg JD, PD)</p>  <p style="text-align: right;">0131-3</p>

Figure 1: Pin Configurations (Cont.)

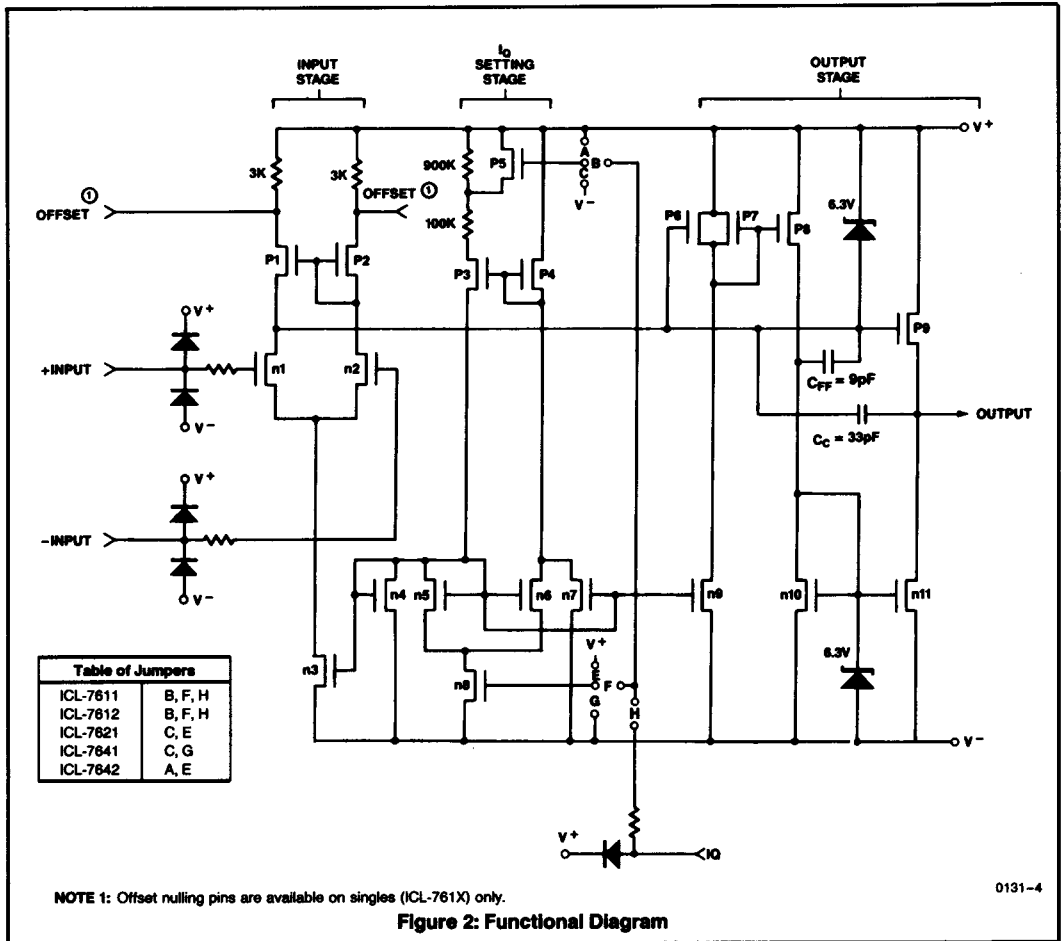


Figure 2: Functional Diagram

ICL76XX

ABSOLUTE MAXIMUM RATINGS

Total Supply Voltage V^+ to V^- 18V
 Input Voltage $V^- - 0.3$ to $V^+ + 0.3$ V
 Differential Input Voltage^[1] $\pm [(V^+ + 0.3) - (V^- - 0.3)]$ V
 Duration of Output Short Circuit^[2] Unlimited

Continuous Power Dissipation

	@25°C	Above 25°C
		derate as below:
TO-99	250mW	2mW/°C
8 Lead Minidip	250mW	2mW/°C
14 Lead CERDIP	500mW	4mW/°C
16 Lead Plastic	375mW	3mW/°C

Storage Temperature Range -65°C to +150°C
 Operating Temperature Range
 ICL76XXM -55°C to +125°C
 Lead Temperature (Soldering, 10sec) 300°C

2

NOTE: Stresses above those listed under "Absolute Maximum Ratings" may cause permanent damage to the device. These are stress ratings only and functional operation of the device at these or any other conditions above those indicated in the operational sections of the specifications is not implied. Exposure to absolute maximum rating conditions for extended periods may affect device reliability.

NOTE 1. Long term offset voltage stability will be degraded if large input differential voltages are applied for long periods of time.
NOTE 2. The outputs may be shorted to ground or to either supply, for $V_{SUPP} \leq 10V$. Care must be taken to insure that the dissipation rating is not exceeded.

ELECTRICAL CHARACTERISTICS (7611/12 and 7621 ONLY)

($V_{SUPPLY} = \pm 5.0V$, $T_A = 25^\circ C$, unless otherwise specified.)

Symbol	Parameter	Test Conditions	76XXA			76XXB			76XXD			Units
			Min	Typ	Max	Min	Typ	Max	Min	Typ	Max	
V_{OS}	Input Offset Voltage	$R_S \leq 100k\Omega$, $T_A = 25^\circ C$ $T_{MIN} \leq T_A \leq T_{MAX}$			2 3			5 7			15 20	mV
$\Delta V_{OS}/\Delta T$	Temperature Coefficient of V_{OS}	$R_S \leq 100k\Omega$		10			15			25		$\mu V/^\circ C$
I_{OS}	Input Offset Current	$T_A = 25^\circ C$ $\Delta T_A = M$		0.5	30 800		0.5	30 800		0.5	30 800	pA
I_{BIAS}	Input Bias Current	$T_A = 25^\circ C$ $\Delta T_A = M$		1.0	50 4000		1.0	50 4000		1.0	50 4000	pA
V_{CMR}	Common Mode Voltage Range (Except ICL7612)	$I_Q = 10\mu A^{(1)}$ $I_Q = 100\mu A$ $I_Q = 1mA^{(1)}$	± 4.4 ± 4.2 ± 3.7			± 4.4 ± 4.2 ± 3.7			± 4.4 ± 4.2 ± 3.7			V
V_{CMR}	Extended Common Mode Voltage Range (ICL7612 Only)	$I_Q = 10\mu A$ $I_Q = 100\mu A$ $I_Q = 1mA$	± 5.3 +5.3 -5.1 +5.3 -4.5			± 5.3 +5.3 -5.1 +5.3 -4.5			± 5.3 +5.3 -5.1 +5.3 -4.5			V
V_{OUT}	Output Voltage Swing	(1) $I_Q = 10\mu A$, $R_L = 1M\Omega$ $T_A = 25^\circ C$ $\Delta T_A = M$ $I_Q = 100\mu A$, $R_L = 100k\Omega$ $T_A = 25^\circ C$ $\Delta T_A = M$ (1) $I_Q = 1mA$, $R_L = 10k\Omega$ $T_A = 25^\circ C$ $\Delta T_A = M$	± 4.9 ± 4.7 ± 4.9 ± 4.5 ± 4.5 ± 4.0			± 4.9 ± 4.7 ± 4.9 ± 4.5 ± 4.5 ± 4.0			± 4.9 ± 4.7 ± 4.9 ± 4.5 ± 4.5 ± 4.0			V

ICL76XX

ELECTRICAL CHARACTERISTICS (7611/12 and 7621 ONLY) (Continued)

(V_{SUPPLY} = ±5.0V, T_A = 25°C, unless otherwise specified.)

Symbol	Parameter	Test Conditions	76XXA			76XXB			76XXD			Units
			Min	Typ	Max	Min	Typ	Max	Min	Typ	Max	
A _{VOL}	Large Signal Voltage Gain	V _O = ±4.0V, R _L = 1MΩ I _Q = 10μA ⁽¹⁾ , T _A = 25°C ΔT _A = M	86 74	104		80 68	104		80 68	104		dB
		V _O = ±4.0V, R _L = 100kΩ I _Q = 100μA, T _A = 25°C ΔT _A = M	86 74	102		80 68	102		80 68	102		
		V _O = ±4.0V, R _L = 10kΩ I _Q = 1mA ⁽¹⁾ , T _A = 25°C ΔT _A = M	80 72	83		76 68	83		76 68	83		
GBW	Unity Gain Bandwidth	I _Q = 10μA ⁽¹⁾ I _Q = 100μA I _Q = 1mA ⁽¹⁾		0.044 0.48 1.4		0.044 0.48 1.4		0.044 0.48 1.4			MHz	
R _{IN}	Input Resistance			10 ¹²		10 ¹²		10 ¹²			Ω	
CMRR	Common Mode Rejection Ratio	R _S ≤ 100kΩ, I _Q = 10μA ⁽¹⁾	76	96		70	96		70	96		dB
		R _S ≤ 100kΩ, I _Q = 100μA	76	91		70	91		70	91		
		R _S ≤ 100kΩ, I _Q = 1mA ⁽¹⁾	66	87		60	87		60	87		
PSRR	Power Supply Rejection Ratio	R _S ≤ 100kΩ, I _Q = 10μA ⁽¹⁾	80	94		80	94		80	94		dB
		R _S ≤ 100kΩ, I _Q = 100μA	80	86		80	86		80	86		
		R _S ≤ 100kΩ, I _Q = 1mA ⁽¹⁾	70	77		70	77		70	77		
e _n	Input Referred Noise Voltage	R _S = 100Ω, f = 1kHz		100		100		100			nV/√Hz	
i _n	Input Referred Noise Current	R _S = 100Ω, f = 1kHz		0.01		0.01		0.01			pA/√Hz	
I _{SUPPLY}	Supply Current (Per Amplifier)	No Signal, No Load I _Q SET = +5V ⁽¹⁾ I _Q SET = 0V I _Q SET = -5V ⁽¹⁾		0.01 0.1 1.0	0.02 0.25 2.5		0.01 0.1 1.0	0.02 0.25 2.5		0.01 0.1 1.0	0.02 0.25 2.5	mA
V _{O1} /V _{O2}	Channel Separation	A _{VOL} = 100		120		120		120			dB	
SR	Slew Rate	A _{VOL} = 1, C _L = 100pF V _{IN} = 8Vp-p I _Q = 10μA ⁽¹⁾ , R _L = 1MΩ I _Q = 100μA, R _L = 100kΩ I _Q = 1mA ⁽¹⁾ , R _L = 10kΩ		0.016 0.16 1.6		0.016 0.16 1.6		0.016 0.16 1.6			V/μs	
t _r	Rise Time	V _{IN} = 50mV, C _L = 100pF I _Q = 10μA ⁽¹⁾ , R _L = 1MΩ I _Q = 100μA, R _L = 100kΩ I _Q = 1mA ⁽¹⁾ , R _L = 10kΩ		20 2 0.9		20 2 0.9		20 2 0.9			μs	
	Overshoot Factor	V _{IN} = 50mV, C _L = 100pF I _Q = 10μA ⁽¹⁾ , R _L = 1MΩ I _Q = 100μA, R _L = 100kΩ I _Q = 1mA ⁽¹⁾ , R _L = 10kΩ		5 10 40		5 10 40		5 10 40			%	

NOTES: 1. ICL7611, 7612 only.

M = Military Temperature Range: -55°C to +125°C

ICL76XX

ELECTRICAL CHARACTERISTICS (7641/42 ONLY)

(V_{SUPPLY} = ±5.0V, T_A = 25°C, unless otherwise specified.)

Symbol	Parameter	Test Conditions	76XXC (6)			76XXE (6)			Units
			Min	Typ	Max	Min	Typ	Max	
V _{OS}	Input Offset Voltage	R _S ≤ 100kΩ, T _A = 25°C T _{MIN} ≤ T _A ≤ T _{MAX}			10 15			20 25	mV
ΔV _{OS} /ΔT	Temperature Coefficient of V _{OS}	R _S ≤ 100kΩ		20			30		
I _{OS}	Input Offset Current	T _A = 25°C ΔT _A = M		0.5	30 800		0.5	30 800	pA
I _{BIAS}	Input Bias Current	T _A = 25°C ΔT _A = M		1.0	50 4000		1.0	50 4000	pA
V _{CMR}	Common Mode Voltage Range	I _Q = 10μA (ICL7642) I _Q = 1mA (ICL7641)	±4.4 ±3.7			±4.4 ±3.7			V
V _{OUT}	Output Voltage Swing	ICL7642 I _Q = 10μA, R _L = 1MΩ T _A = 25°C ΔT _A = M	±4.9 ±4.7			±4.9 ±4.7			V
		ICL7641 I _Q = 1mA, R _L = 10kΩ T _A = 25°C ΔT _A = M	±4.5 ±4.0			±4.5 ±4.0			
A _{VOL}	Large Signal Voltage Gain	ICL7642 V _O = ±4.0V, R _L = 1MΩ I _Q = 10μA, T _A = 25°C ΔT _A = M	80 68	104		80 68	104		dB
		ICL7641 V _O = ±4.0V, R _L = 10kΩ I _Q = 1mA, T _A = 25°C ΔT _A = M	76 68	98		76 68	98		
GBW	Unity Gain Bandwidth	I _Q = 10μA (ICL7642) I _Q = 1mA (ICL7641)		0.044 1.4			0.044 1.4		MHz
R _{IN}	Input Resistance			10 ¹²			10 ¹²		Ω
CMRR	Common Mode Rejection Ratio	R _S ≤ 100kΩ, I _Q = 10μA ⁽¹⁾ R _S ≤ 100kΩ, I _Q = 1mA ⁽²⁾	70 60	96 87		70 60	96 87		dB

ICL76XX**ELECTRICAL CHARACTERISTICS (7641/42 ONLY)** (Continued)(V_{SUPPLY} = ±5.0V, T_A = 25°C, unless otherwise specified.)

Symbol	Parameter	Test Conditions	76XXC (6)			76XXE (6)			Units
			Min	Typ	Max	Min	Typ	Max	
PSRR	Power Supply Rejection Ratio	R _S ≤ 100kΩ, I _Q = 10μA ⁽¹⁾ R _S ≤ 100kΩ, I _Q = 1mA ⁽²⁾	80 70	94 77		80 70	94 77		dB
e _n	Input Referred Noise Voltage	R _S = 100Ω, f = 1kHz		100			100		nV/√Hz
i _n	Input Referred Noise Current	R _S = 100Ω, f = 1kHz		0.01			0.01		pA/√Hz
I _{SUPPLY}	Supply Current (Per Amplifier)	No Signal, No Load 7642 ONLY I _Q = 10μA (ICL7642) I _Q = 1mA (ICL7641)		0.01 0.01 1.0	0.03 0.022 2.5		0.01 0.01 1.0	0.03 0.022 2.5	mA
V _{O1} /V _{O2}	Channel Separation	A _{VOL} = 100		120			120		dB
SR	Slew Rate	A _{VOL} = 1, C _L = 100pF V _{IN} = 8Vp-p I _Q = 10μA ⁽¹⁾ , R _L = 1MΩ I _Q = 1mA ⁽²⁾ , R _L = 10kΩ		0.016 1.6			0.016 1.6		V/μs
t _r	Rise Time	V _{IN} = 50mV, C _L = 100pF I _Q = 10μA ⁽¹⁾ , R _L = 1MΩ I _Q = 1mA ⁽²⁾ , R _L = 10kΩ		20 0.9			20 0.9		μs
	Overshoot Factor	V _{IN} = 50mV, C _L = 100pF I _Q = 10μA ⁽¹⁾ , R _L = 1MΩ I _Q = 1mA ⁽²⁾ , R _L = 10kΩ		5 40			5 40		%

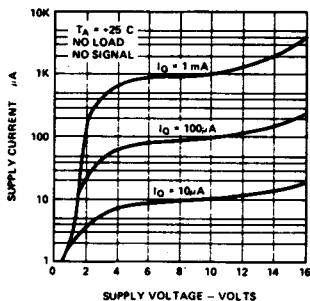
NOTES: 1. ICL7642 only.
2. ICL7641 only.

For Test Conditions:
M = Military Temperature Range: -55°C to +125°C

ICL76XX

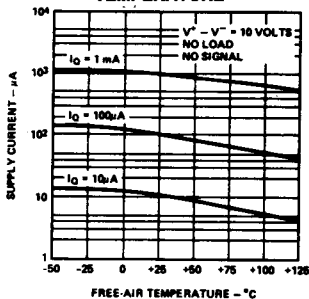
TYPICAL PERFORMANCE CHARACTERISTICS

SUPPLY CURRENT PER AMPLIFIER AS A FUNCTION OF SUPPLY VOLTAGE



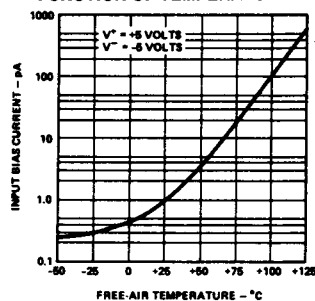
0131-5

SUPPLY CURRENT PER AMPLIFIER AS A FUNCTION OF FREE-AIR TEMPERATURE



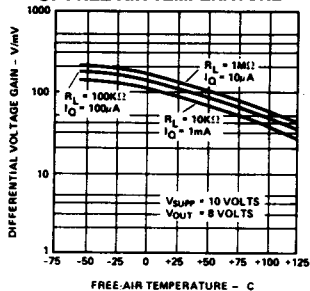
0131-6

INPUT BIAS CURRENT AS A FUNCTION OF TEMPERATURE



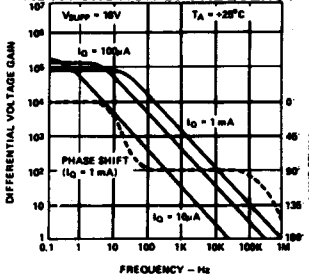
0131-7

LARGE SIGNAL DIFFERENTIAL VOLTAGE GAIN AS A FUNCTION OF FREE-AIR TEMPERATURE



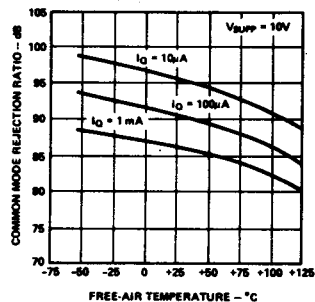
0131-8

LARGE SIGNAL DIFFERENTIAL VOLTAGE GAIN AND PHASE SHIFT AS A FUNCTION OF FREQUENCY



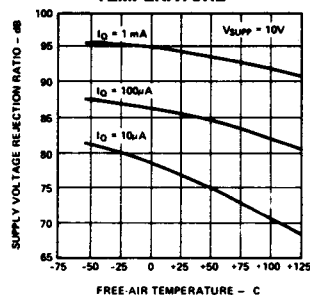
0131-9

COMMON MODE REJECTION RATIO AS A FUNCTION OF FREE-AIR TEMPERATURE



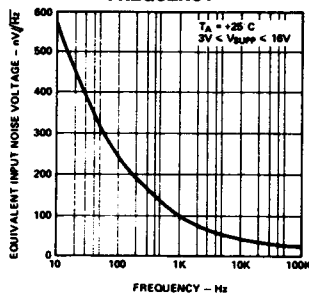
0131-10

POWER SUPPLY REJECTION RATIO AS A FUNCTION OF FREE-AIR TEMPERATURE



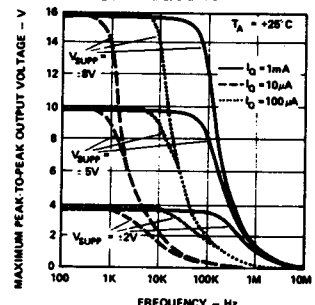
0131-11

EQUIVALENT INPUT NOISE VOLTAGE AS A FUNCTION OF FREQUENCY



0131-12

PEAK-TO-PEAK OUTPUT VOLTAGE AS A FUNCTION OF FREQUENCY



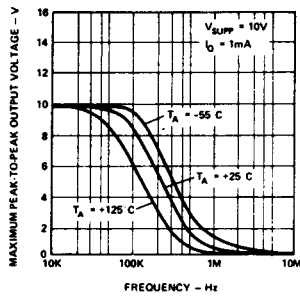
0131-13

2

ICL76XX

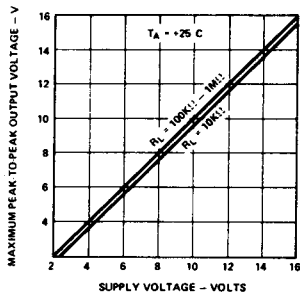
TYPICAL PERFORMANCE CHARACTERISTICS

MAXIMUM PEAK-TO-PEAK OUTPUT VOLTAGE AS A FUNCTION OF FREQUENCY



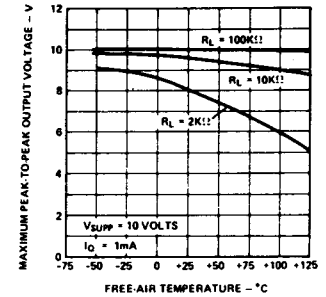
0131-14

MAXIMUM PEAK-TO-PEAK OUTPUT VOLTAGE AS A FUNCTION OF SUPPLY VOLTAGE



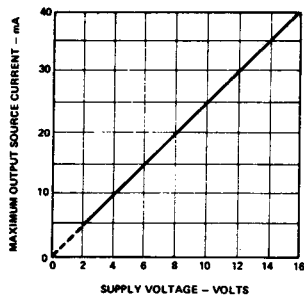
0131-15

MAXIMUM PEAK-TO-PEAK OUTPUT VOLTAGE AS A FUNCTION OF FREE-AIR TEMPERATURE



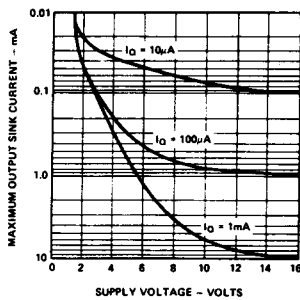
0131-16

MAXIMUM OUTPUT SOURCE CURRENT AS A FUNCTION OF SUPPLY VOLTAGE



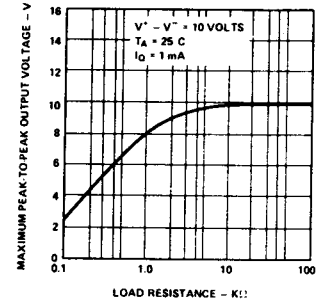
0131-17

MAXIMUM OUTPUT SINK CURRENT AS A FUNCTION OF SUPPLY VOLTAGE



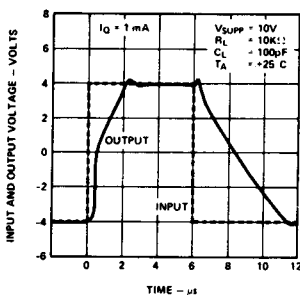
0131-18

MAXIMUM PEAK-TO-PEAK OUTPUT VOLTAGE AS A FUNCTION OF LOAD RESISTANCE



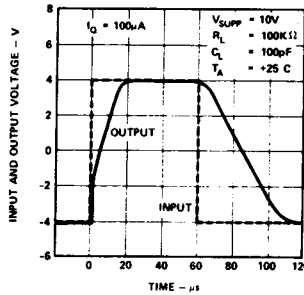
0131-19

VOLTAGE FOLLOWER LARGE SIGNAL PULSE RESPONSE



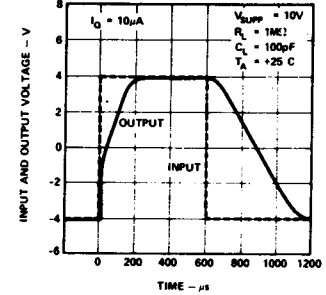
0131-20

VOLTAGE FOLLOWER LARGE SIGNAL PULSE RESPONSE



0131-21

VOLTAGE FOLLOWER LARGE SIGNAL PULSE RESPONSE



0131-22

DETAILED DESCRIPTION

Static Protection

All devices are static protected by the use of input diodes. However, strong static fields should be avoided, as it is possible for the strong fields to cause degraded diode junction characteristics, which may result in increased input leakage currents.

Latchup Avoidance

Junction-isolated CMOS circuits employ configurations which produce a parasitic 4-layer (p-n-p-n) structure. The 4-layer structure has characteristics similar to an SCR, and under certain circumstances may be triggered into a low impedance state resulting in excessive supply current. To avoid this condition, no voltage greater than 0.3V beyond the supply rails may be applied to any pin. In general, the op-amp supplies must be established simultaneously with, or before any input signals are applied. If this is not possible, the drive circuits must limit input current flow to 2mA to prevent latchup.

Choosing the Proper I_Q

Each device in the ICL76XX family has a similar I_Q set-up scheme, which allows the amplifier to be set to nominal quiescent currents of 10 μ A, 100 μ A or 1mA. These current settings change only very slightly over the entire supply voltage range. The ICL7611/12 have an external I_Q control terminal, permitting user selection of each amplifiers' quiescent current. The 7621 and 7641/42 have fixed I_Q settings (refer to selector guide for details.) To set the I_Q of programmable versions, connect the I_Q terminal as follows:

$I_Q = 10\mu\text{A}$ — I_Q pin to V^+

$I_Q = 100\mu\text{A}$ — I_Q pin to ground. If this is not possible, any voltage from $V^+ - 0.8$ to $V^- + 0.8$ can be used.

$I_Q = 1\text{mA}$ — I_Q pin to V^-

NOTE: The negative output current available is a function of the quiescent current setting. For maximum p-p output voltage swings into low impedance loads, I_Q of 1mA should be selected.

Output Stage and Load Driving Considerations

Each amplifiers' quiescent current flows primarily in the output stage. This is approximately 70% of the I_Q settings. This allows output swings to almost the supply rails for output loads of 1M Ω , 100k Ω , and 10k Ω , using the output stage in a highly linear class A mode. In this mode, crossover distortion is avoided and the voltage gain is maximized. However, the output stage can also be operated in Class AB for higher output currents. (See graphs under Typical Operating Characteristics). During the transition from Class A to Class B operation, the output transfer characteristic is non-linear and the voltage gain decreases.

A special feature of the output stage is that it approximates a transconductance amplifier, and its gain is directly proportional to load impedance. Approximately the same open loop gains are obtained at each of the I_Q settings if corresponding loads of 10k Ω , 100k Ω , and 1M Ω are used.

Input Offset Nulling

For ICL7611/12 models provided with OFFSET NULLING pins, nulling may be achieved by connecting a 25K pot between the OFFSET terminals with the wiper connected to V^+ . At quiescent currents of 1mA and 100 μ A, the nulling range provided is adequate for all V_{OS} selections; however with $I_Q = 10\mu\text{A}$, nulling may not be possible with higher values of V_{OS} .

Frequency Compensation

The ICL76XX are internally compensated, and are stable for closed loop gains as low as unity with capacitive loads up to 100pF.

Extended Common Mode Input Range

The ICL7612 incorporates additional processing which allows the input CMVR to exceed each power supply rail by 0.1 volt.

ICL76XX

The user is cautioned that, due to extremely high input impedances, care must be exercised in layout, construction, board cleanliness, and supply filtering to avoid hum and noise pickup.

APPLICATIONS

Note that in no case is I_Q shown. The value of I_Q must be chosen by the designer with regard to frequency response and power dissipation.

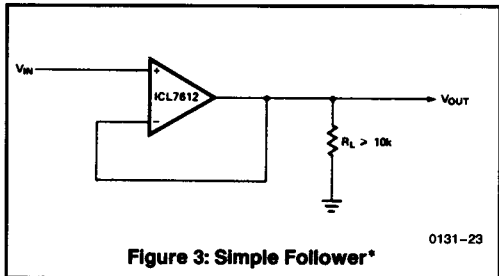


Figure 3: Simple Follower*

0131-23

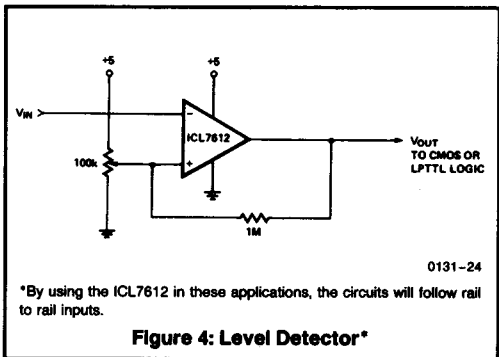


Figure 4: Level Detector*

0131-24

*By using the ICL7612 in these applications, the circuits will follow rail to rail inputs.

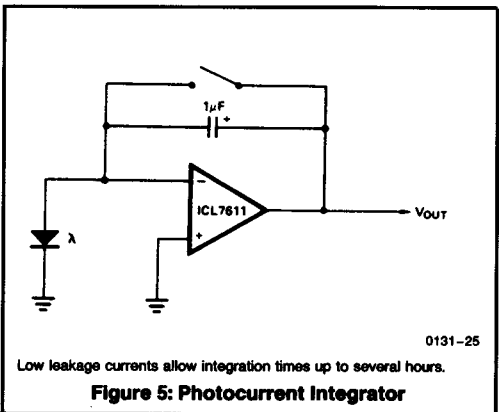


Figure 5: Photocurrent Integrator

0131-25

Low leakage currents allow integration times up to several hours.

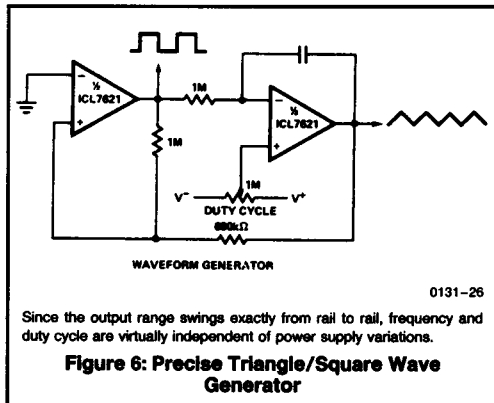


Figure 6: Precise Triangle/Square Wave Generator

0131-26

Since the output range swings exactly from rail to rail, frequency and duty cycle are virtually independent of power supply variations.

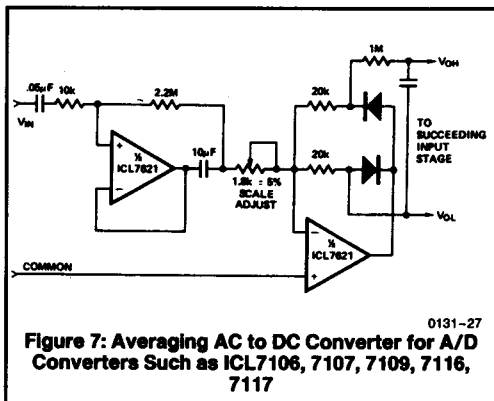


Figure 7: Averaging AC to DC Converter for A/D Converters Such as ICL7106, 7107, 7109, 7116, 7117

0131-27

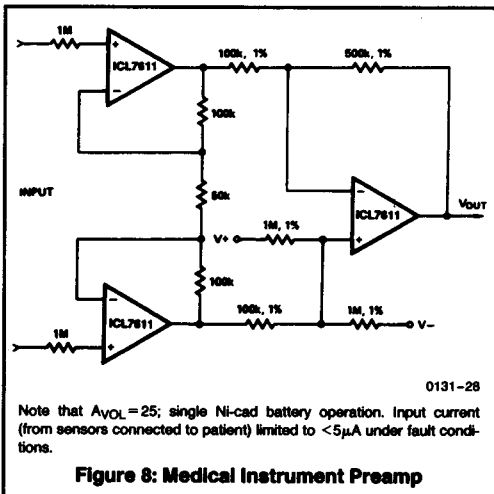


Figure 8: Medical Instrument Preamp

0131-28

Note that $A_{VOL} = 25$; single Ni-cad battery operation. Input current (from sensors connected to patient) limited to $< 5\mu A$ under fault conditions.

ICL76XX

2

