

High Intensity LED, Ø 5 mm Tinted Diffused

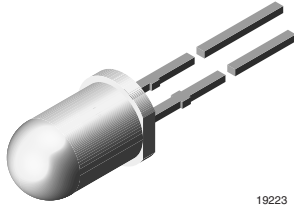

19223

DESCRIPTION

This LED contains the double heterojunction (DH) GaAlAs on GaAs technology.

This deep red LED can be utilized over a wide range of drive current. It can be DC or pulse driven to achieve desired light output.

The device is available in a tinted diffused 5 mm package with a wide radiation angle.

PRODUCT GROUP AND PACKAGE DATA

- Product group: LED
- Package: 5 mm
- Product series: standard
- Angle of half intensity: $\pm 30^\circ$

FEATURES

- Exceptional brightness
- Wide viewing angle
- Low forward voltage
- 5 mm (T-1 $\frac{3}{4}$ ") tinted diffused package
- Deep red color
- Very high intensity even at low drive currents
- Categorized for luminous intensity
- Outstanding material efficiency
- Compliant to RoHS directive 2002/95/EC and in accordance to WEEE 2002/96/EC

RoHS
COMPLIANT

APPLICATIONS

- Bright ambient lighting conditions
- Battery powered equipment
- Indoor and outdoor information displays
- Portable equipment
- Telecommunication indicators
- General use

PARTS TABLE

PART	COLOR, LUMINOUS INTENSITY	TECHNOLOGY
TLDR5400	Red, $I_V \geq 35$ mcd	GaAlAs on GaAs

ABSOLUTE MAXIMUM RATINGS ¹⁾ TLDR5400

PARAMETER	TEST CONDITION	SYMBOL	VALUE	UNIT
Reverse voltage ²⁾		V_R	6	V
DC Forward current		I_F	50	mA
Surge forward current	$t_p \leq 10 \mu s$	I_{FSM}	1	A
Power dissipation		P_V	100	mW
Junction temperature		T_j	100	$^\circ C$
Operating temperature range		T_{amb}	- 40 to + 100	$^\circ C$
Storage temperature range		T_{stg}	- 55 to + 100	$^\circ C$
Soldering temperature	$t \leq 5$ s, 2 mm from body	T_{sd}	260	$^\circ C$
Thermal resistance junction/ambient		R_{thJA}	350	K/W

Note:

¹⁾ $T_{amb} = 25^\circ C$, unless otherwise specified

²⁾ Driving the LED in reverse direction is suitable for a short term application

OPTICAL AND ELECTRICAL CHARACTERISTICS ¹⁾ TLDR5400, RED						
PARAMETER	TEST CONDITION	SYMBOL	MIN.	TYP.	MAX.	UNIT
Luminous intensity	$I_F = 20 \text{ mA}$	I_V	35	70		mcd
Luminous intensity	$I_F = 1 \text{ mA}$	I_V		3		mcd
Dominant wavelength	$I_F = 20 \text{ mA}$	λ_d		648		nm
Peak wavelength	$I_F = 20 \text{ mA}$	λ_p		650		nm
Spectral line half width		$\Delta\lambda$		20		nm
Angle of half intensity	$I_F = 20 \text{ mA}$	φ		± 30		deg
Forward voltage	$I_F = 20 \text{ mA}$	V_F		1.8	2.2	V
Reverse current	$V_R = 6 \text{ V}$	I_R			10	μA
Junction capacitance	$V_R = 0, f = 1 \text{ MHz}$	C_j		30		pF

Note:

¹⁾ $T_{amb} = 25 \text{ }^\circ\text{C}$, unless otherwise specified

LUMINOUS INTENSITY CLASSIFICATION		
GROUP	LUMINOUS INTENSITY (mcd)	
STANDARD	MIN.	MAX.
Tb	35	50
U	40	80
V	63	125
W	100	200
X	130	260
Y	180	360
Z	240	480
AA	320	640
BB	430	860

Note:

Luminous intensity is tested at a current pulse duration of 25 ms and an accuracy of $\pm 11 \%$.

The above type numbers represent the order groups which include only a few brightness groups. Only one group will be shipped on each bag (there will be no mixing of two groups in each bag).

In order to ensure availability, single brightness groups will not be orderable.

In a similar manner for colors where wavelength groups are measured and binned, single wavelength groups will be shipped on any one bag.

In order to ensure availability, single wavelength groups will not be orderable.

TYPICAL CHARACTERISTICS

$T_{amb} = 25 \text{ }^\circ\text{C}$, unless otherwise specified

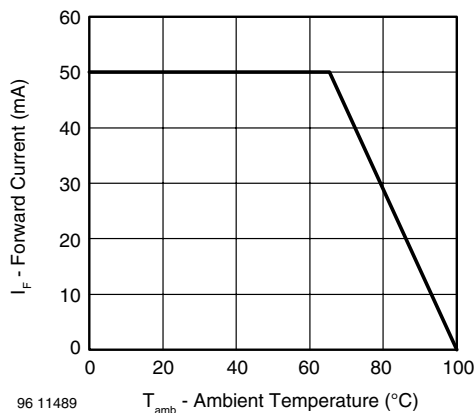

Figure 1. Forward Current vs. Ambient Temperature for AlInGaP

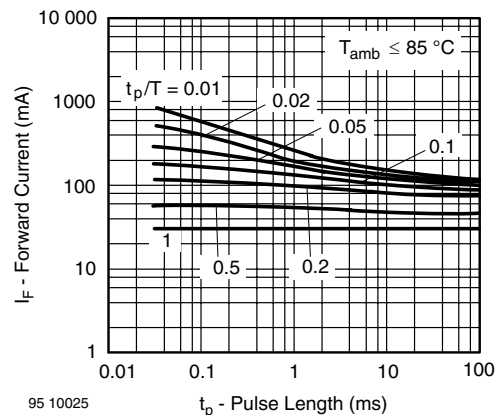
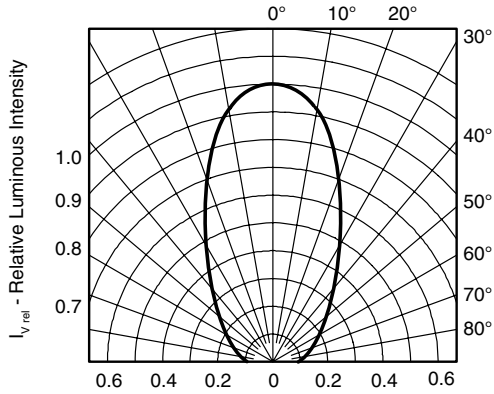
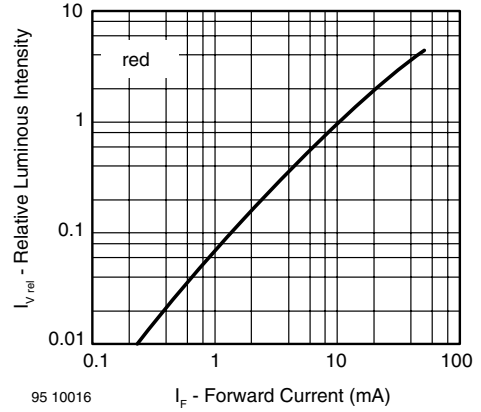

Figure 2. Forward Current vs. Pulse Length



95 10021

Figure 3. Rel. Luminous Intensity vs. Angular Displacement



95 10016

Figure 6. Relative Luminous Intensity vs. Forward Current

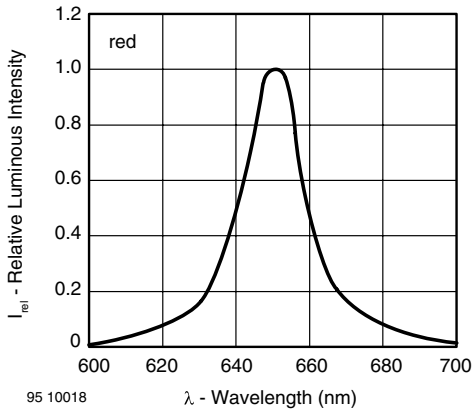

95 10018

Figure 4. Relative Intensity vs. Wavelength

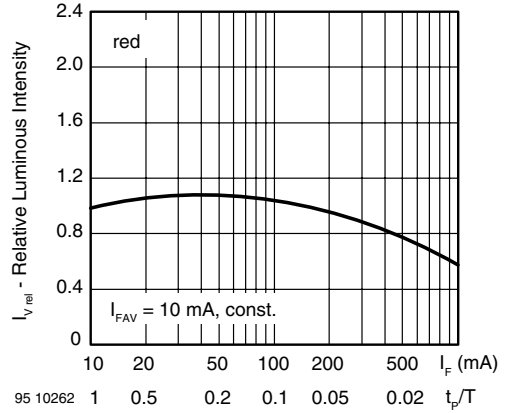

95 10262

Figure 7. Rel. Lumin. Intensity vs. Forw. Current/Duty Cycle

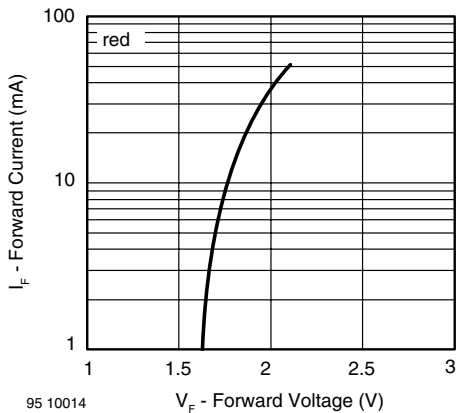

95 10014

Figure 5. Forward Current vs. Forward Voltage

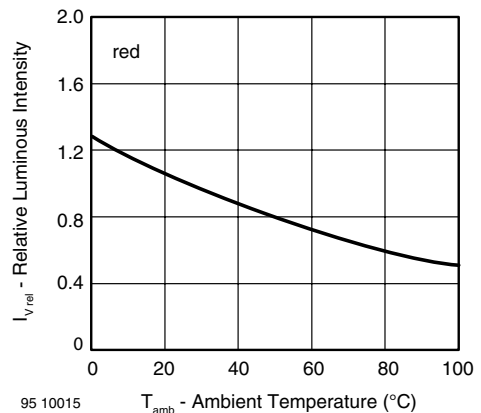

95 10015

Figure 8. Rel. Luminous Intensity vs. Ambient Temperature

PACKAGE DIMENSIONS in millimeters

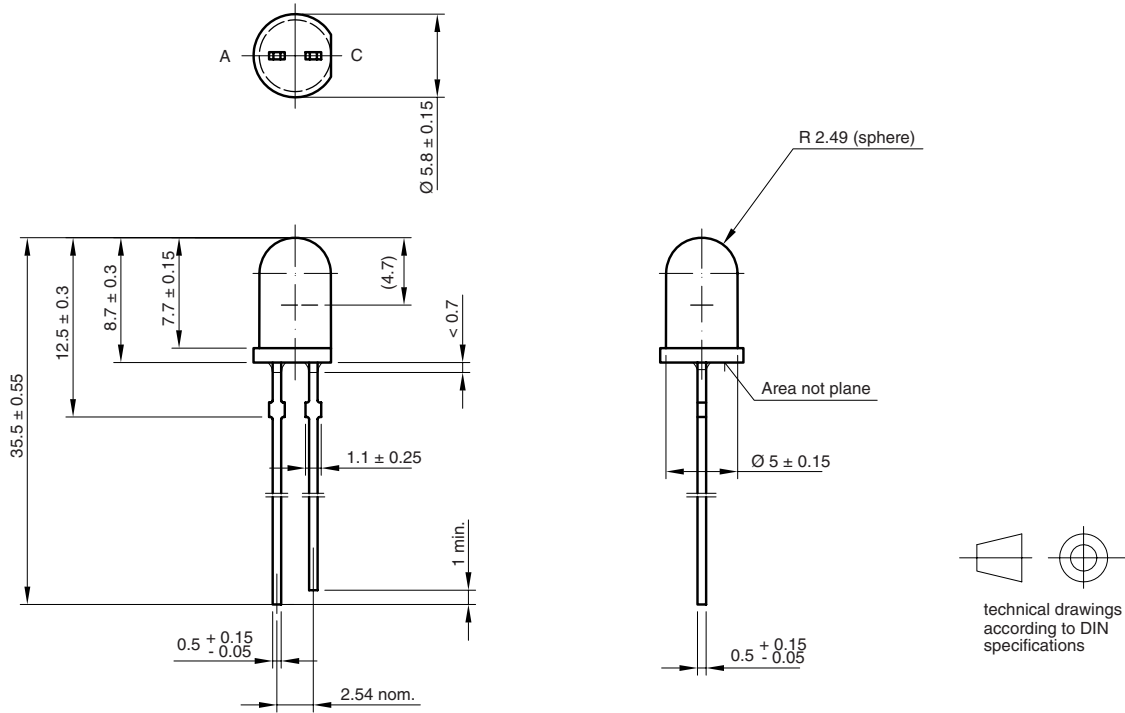

6.544-5258.02-4
Issue: 6; 19.05.09
95 10916



Disclaimer

ALL PRODUCT, PRODUCT SPECIFICATIONS AND DATA ARE SUBJECT TO CHANGE WITHOUT NOTICE TO IMPROVE RELIABILITY, FUNCTION OR DESIGN OR OTHERWISE.

Vishay Intertechnology, Inc., its affiliates, agents, and employees, and all persons acting on its or their behalf (collectively, "Vishay"), disclaim any and all liability for any errors, inaccuracies or incompleteness contained in any datasheet or in any other disclosure relating to any product.

Vishay makes no warranty, representation or guarantee regarding the suitability of the products for any particular purpose or the continuing production of any product. To the maximum extent permitted by applicable law, Vishay disclaims (i) any and all liability arising out of the application or use of any product, (ii) any and all liability, including without limitation special, consequential or incidental damages, and (iii) any and all implied warranties, including warranties of fitness for particular purpose, non-infringement and merchantability.

Statements regarding the suitability of products for certain types of applications are based on Vishay's knowledge of typical requirements that are often placed on Vishay products in generic applications. Such statements are not binding statements about the suitability of products for a particular application. It is the customer's responsibility to validate that a particular product with the properties described in the product specification is suitable for use in a particular application. Parameters provided in datasheets and/or specifications may vary in different applications and performance may vary over time. All operating parameters, including typical parameters, must be validated for each customer application by the customer's technical experts. Product specifications do not expand or otherwise modify Vishay's terms and conditions of purchase, including but not limited to the warranty expressed therein.

Except as expressly indicated in writing, Vishay products are not designed for use in medical, life-saving, or life-sustaining applications or for any other application in which the failure of the Vishay product could result in personal injury or death. Customers using or selling Vishay products not expressly indicated for use in such applications do so at their own risk and agree to fully indemnify and hold Vishay and its distributors harmless from and against any and all claims, liabilities, expenses and damages arising or resulting in connection with such use or sale, including attorneys fees, even if such claim alleges that Vishay or its distributor was negligent regarding the design or manufacture of the part. Please contact authorized Vishay personnel to obtain written terms and conditions regarding products designed for such applications.

No license, express or implied, by estoppel or otherwise, to any intellectual property rights is granted by this document or by any conduct of Vishay. Product names and markings noted herein may be trademarks of their respective owners.