

HER201G THRU HER208G

List

List..... 1

Package outline..... 2

Features..... 2

Mechanical data..... 2

Maximum ratings2

Rating and characteristic curves..... 3

Pinning information.....4

Marking..... 4

Taping & bulk specifications for AXIAL devices..... 4

Suggested thermal profiles for soldering processes..... 5

High reliability test capabilities.....6

HER201G THRU HER208G

2.0A Axial Leaded High Efficiency Rectifiers-50-1000V

Features

- Axial lead type devices for through hole design.
- High current capability.
- Ultrafast recovery time for high efficiency.
- High surge current capability.
- Glass passivated chip junction.
- Lead-free parts meet RoHS requirements.
- Suffix "-H" indicates Halogen free parts, ex. HER201G-H.

Mechanical data

- Epoxy : UL94-V0 rated flame retardant
- Case : Molded plastic, DO-15
- Lead : Axial leads, solderable per MIL-STD-202, Method 208 guaranteed
- Polarity: Color band denotes cathode end
- Mounting Position : Any
- Weight : Approximated 0.40 gram

Package outline

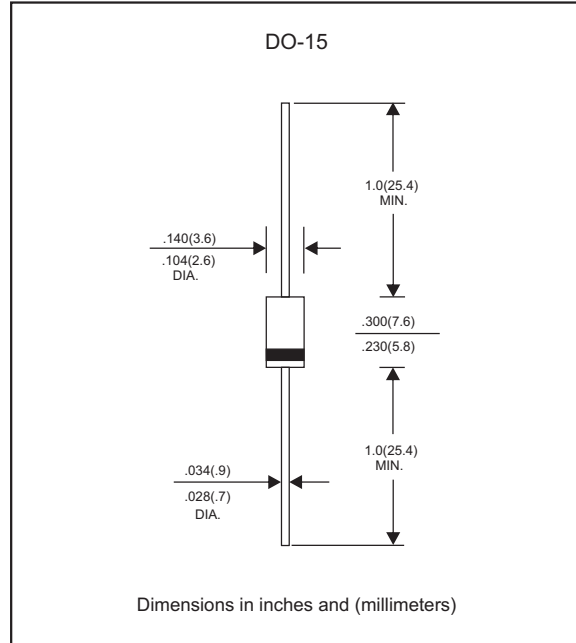

Maximum ratings and Electrical Characteristics (AT $T_A=25^{\circ}\text{C}$ unless otherwise noted)

PARAMETER	CONDITIONS	Symbol	MIN.	TYP.	MAX.	UNIT
Forward rectified current	Ambient temperature = 50°C	I_O			2.0	A
Forward surge current	8.3ms single half sine-wave (JEDEC method)	I_{FSM}			60	A
Reverse current	$V_R = V_{RRM}$ $T_J = 25^{\circ}\text{C}$	I_R			5.0	μA
	$V_R = V_{RRM}$ $T_J = 125^{\circ}\text{C}$				150	
Diode junction capacitance	f=1MHz and applied 4V DC reverse voltage	C_J		30		pF
Storage temperature		T_{STG}	-65		+175	$^{\circ}\text{C}$

SYMBOLS	V_{RRM}^{*1} (V)	V_{RMS}^{*2} (V)	V_R^{*3} (V)	V_F^{*4} (V)	t_{rr}^{*5} (ns)	Operating temperature T_J , ($^{\circ}\text{C}$)
HER201G	50	35	50	1.00	50	
HER202G	100	70	100			
HER203G	200	140	200			
HER204G	300	210	300	1.30		
HER205G	400	280	400			
HER206G	600	420	600	1.85	75	
HER207G	800	560	800			
HER208G	1000	700	1000			

- *1 Repetitive peak reverse voltage
- *2 RMS voltage
- *3 Continuous reverse voltage
- *4 Maximum forward voltage@ $I_F=2.0\text{A}$
- *5 Maximum Reverse recovery time, note 1

Note 1. Reverse recovery time test condition, $I_F=0.5\text{A}$, $I_R=1.0\text{A}$, $I_{RR}=0.25\text{A}$

Rating and characteristic curves (HER201G THRU HER208G)

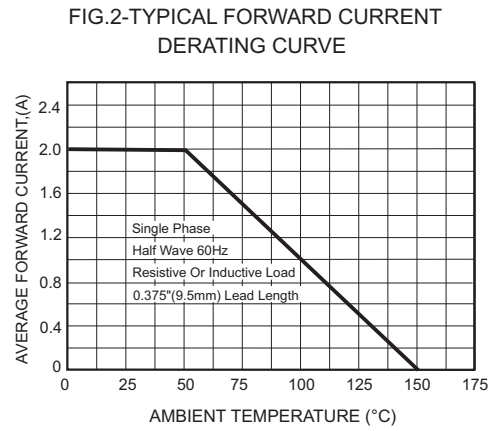
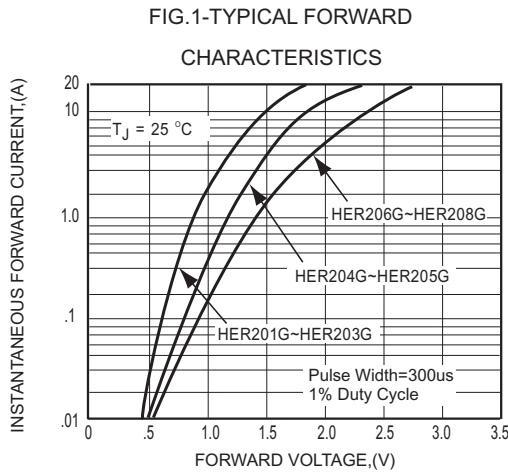
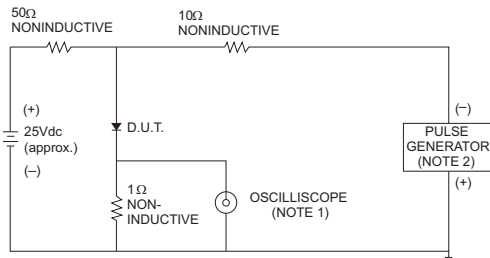

FIG.3- TEST CIRCUIT DIAGRAM AND REVERSE RECOVERY TIME CHARACTERISTICS



NOTES: 1. Rise Time = 7ns max., Input Impedance = 1 megohm, 22pF.
2. Rise Time = 10ns max., Source Impedance = 50 ohms.

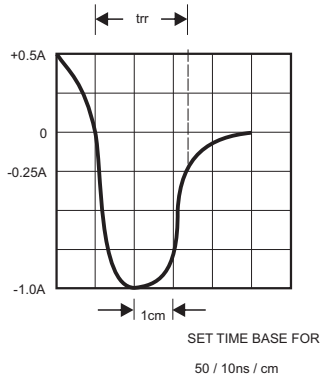

FIG.4-MAXIMUM NON-REPETITIVE FORWARD SURGE CURRENT

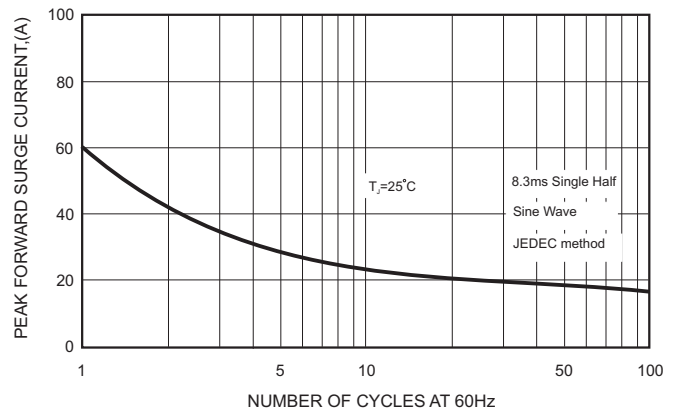
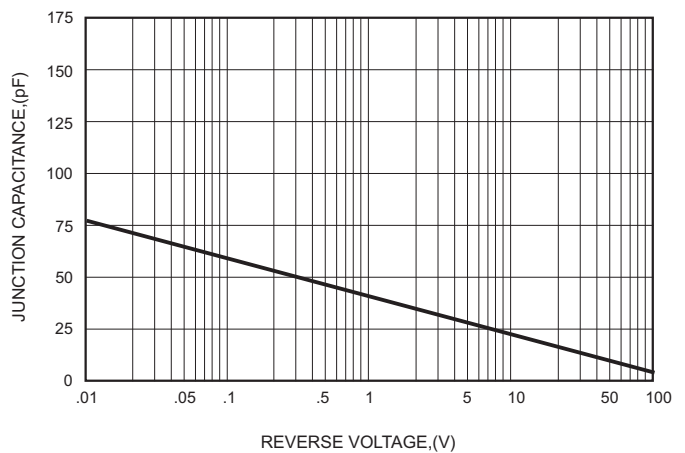

FIG.5-TYPICAL JUNCTION CAPACITANCE



HER201G THRU HER208G

Pinning information

Pin	Simplified outline	Symbol
Pin1 cathode Pin2 anode		

Marking

Type number	Marking code
HER201G	HER201G
HER202G	HER202G
HER203G	HER203G
HER204G	HER204G
HER205G	HER205G
HER206G	HER206G
HER207G	HER207G
HER208G	HER208G

Taping & bulk specifications for AXIAL devices

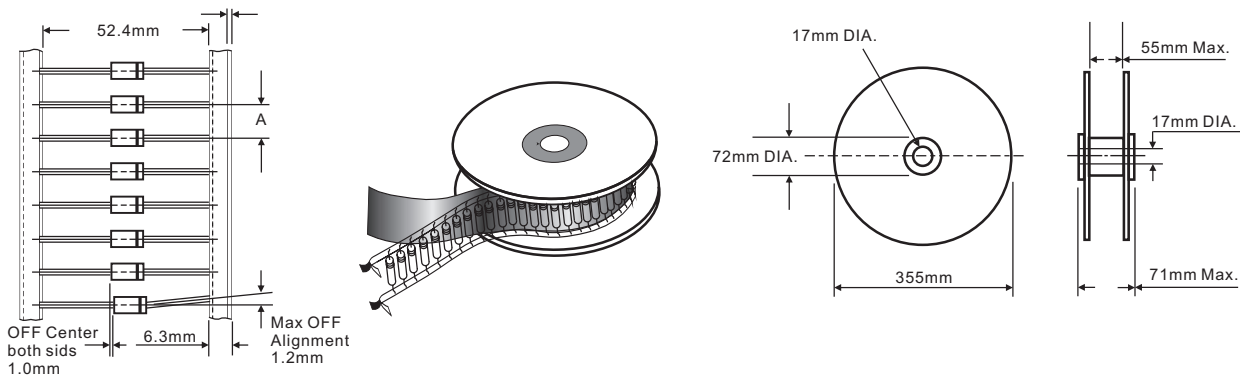

REEL PACKING

DEVICE CASE TYPE	Q'TY 1 (PCS / REEL)	COMPONENT SPACING "A" in FIG. A	CARTON SIZE (m/m)	Q'TY 2 (PCS / CARTON)	APPROX. CROSS WEIGHT(kg)
DO-15	4,000	5 mm	380 * 340 * 370	16,000	9.9

AMMO PACKING

DEVICE CASE TYPE	Q'TY 1 (PCS / BOX)	INNER BOX SIZE (m/m)	CARTON SIZE (m/m)	Q'TY 2 (PCS / CARTON)	APPROX. CROSS WEIGHT(kg)
DO-15	3,000	260 * 83 * 160	440 * 270 * 340	30,000	14.3

HER201G THRU HER208G

BULK PACKING

DEVICE CASE TYPE	Q'TY 1 (PCS / BOX)	INNER BOX SIZE (m/m)	CARTON SIZE (m/m)	Q'TY 2 (PCS / CARTON)	APPROX. CROSS WEIGHT(kg)
DO-15	500	194 * 84 * 20	465 * 220 * 260	25,000	12.9

Suggested thermal profiles for soldering processes

1. Lead free temperature profile wave-soldering

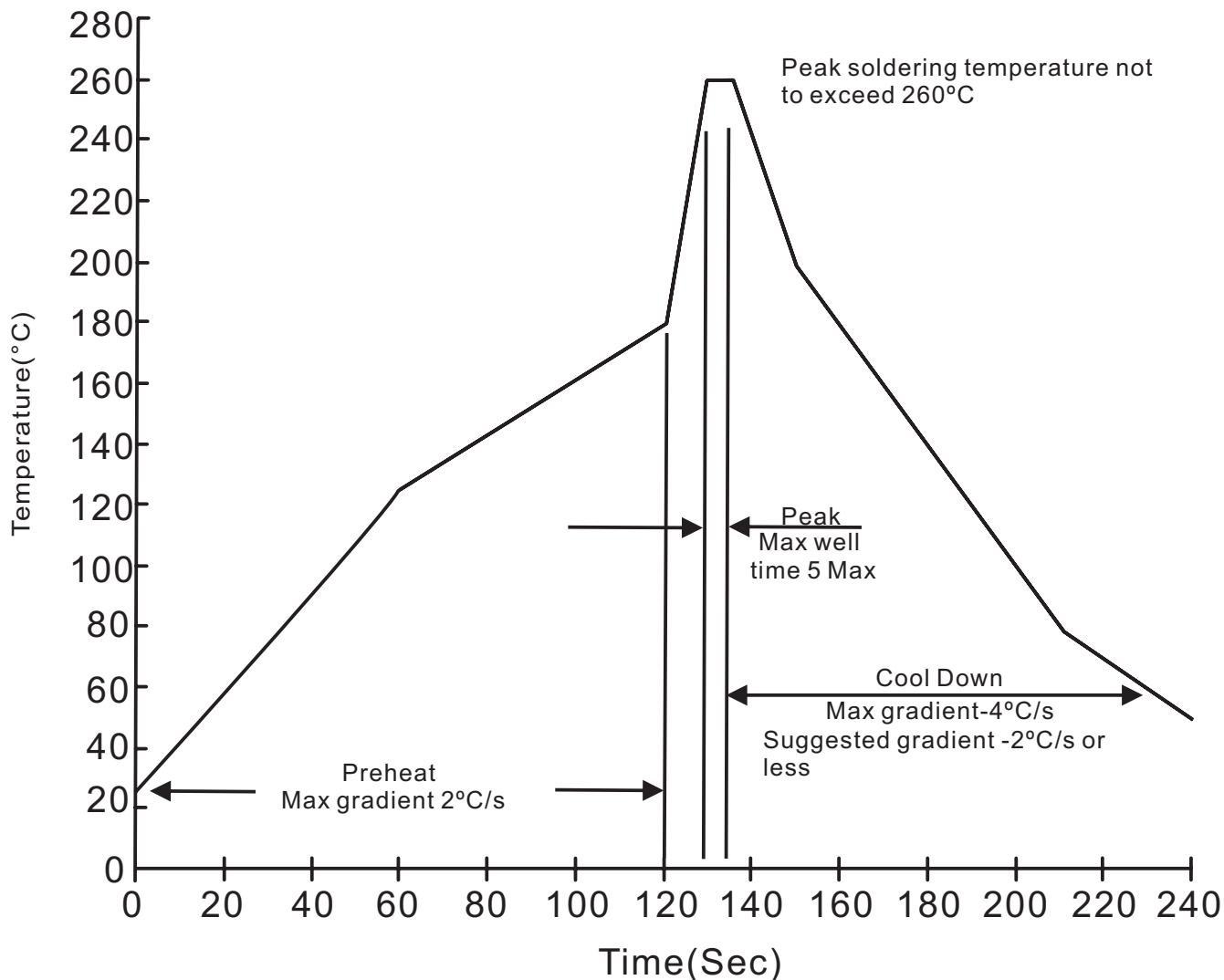

HER201G THRU HER208G**High reliability test capabilities**

Item Test	Conditions	Reference
1. Solder Resistance	at 260±5°C for 10±2sec. immerse body into solder 1/16"±1/32"	MIL-STD-750D METHOD-2031
2. Solderability	at 245±5°C for 5 sec.	MIL-STD-202F METHOD-208
3. Pull Test	1.0kg in axial lead direction for 10 sec. $I_F = I_O$	MIL-STD-202F METHOD-211A
4. Bend Lead	1.0kg weight applied to each lead bending arc 90°±5° for 3 times	MIL-STD-202F METHOD-211A
5. High Temperature Reverse Bias	$V_R = 80\%$ rate at $T_J = 150^\circ\text{C}$ for 168 hrs.	MIL-STD-750D METHOD-1038
6. Forward Operation Life	Rated average rectifier current at $T_A = 25^\circ\text{C}$ for 500hrs. $T_A = 25^\circ\text{C}$, $I_F = I_O$	MIL-STD-750D METHOD-1027
7. Intermittent Operation Life	On state: power on for 5 min. off state: power off for 5 min, on and off for 500 cycles.	MIL-STD-750D METHOD-1036
8. Pressure Cooker	15P _{sig} at $T_A = 121^\circ\text{C}$ for 4 hrs.	JESD22-A102
9. Temperature Cycling	-55°C to +125°C dwelled for 30 min. and transferred for 5min. total 10 cycles.	MIL-STD-750D METHOD-1051
10. Forward Surge	8.3ms single half sine-wave one surge.	MIL-STD-750D METHOD-4066-2
11. Humidity	at $T_A = 85^\circ\text{C}$, RH=85% for 1000hrs.	MIL-STD-750D METHOD-1021
12. High Temperature Storage Life	at 175°C for 1000 hrs.	MIL-STD-750D METHOD-1031