

## Standard Avalanche Sinterglass Diode

### Features

- Glass passivated junction
- Hermetically sealed package
- Controlled avalanche characteristics
- Low reverse current
- High surge current loading
- Lead (Pb)-free component
- Component in accordance to RoHS 2002/95/EC and WEEE 2002/96/EC

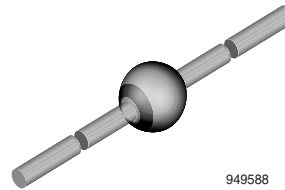

949588

### Mechanical Data

**Case:** SOD-64 Sintered glass case

**Terminals:** Plated axial leads, solderable per MIL-STD-750, Method 2026

**Polarity:** Color band denotes cathode end

**Mounting Position:** Any

**Weight:** approx. 858 mg

### Applications

Rectification, general purpose

### Parts Table

Part	Type differentiation	Package
1N5624	$V_R = 200 \text{ V}; I_{FAV} = 3 \text{ A}$	SOD-64
1N5625	$V_R = 400 \text{ V}; I_{FAV} = 3 \text{ A}$	SOD-64
1N5626	$V_R = 600 \text{ V}; I_{FAV} = 3 \text{ A}$	SOD-64
1N5627	$V_R = 800 \text{ V}; I_{FAV} = 3 \text{ A}$	SOD-64

### Absolute Maximum Ratings

$T_{amb} = 25 \text{ }^\circ\text{C}$ , unless otherwise specified

Parameter	Test condition	Part	Symbol	Value	Unit
Reverse voltage = Repetitive peak reverse voltage	see electrical characteristics	1N5624	$V_R = V_{RRM}$	200	V
		1N5625	$V_R = V_{RRM}$	400	V
		1N5626	$V_R = V_{RRM}$	600	V
		1N5627	$V_R = V_{RRM}$	800	V
Peak forward surge current	$t_p = 10 \text{ ms}$ , half sinewave		$I_{FSM}$	100	A
Repetitive peak forward current			$I_{FRM}$	18	A
Average forward current			$I_{FAV}$	3	A
Pulse avalanche peak power	$t_p = 20 \text{ } \mu\text{s}$ , half sine wave, $T_j = 175 \text{ }^\circ\text{C}$		$P_R$	1000	W
Pulse energy in avalanche mode, non repetitive (inductive load switch off)	$I_{(BR)R} = 1 \text{ A}$ , $T_j = 175 \text{ }^\circ\text{C}$		$E_R$	20	mJ
$i^2 \cdot t$ -rating			$i^2 \cdot t$	40	$\text{A}^2 \cdot \text{s}$
Junction and storage temperature range			$T_j = T_{stg}$	- 55 to + 175	$^\circ\text{C}$

### Maximum Thermal Resistance

$T_{amb} = 25\text{ }^{\circ}\text{C}$ , unless otherwise specified

Parameter	Test condition	Part	Symbol	Value	Unit
Junction ambient	$l = 10\text{ mm}$ , $T_L = \text{constant}$		$R_{thJA}$	25	K/W
	on PC board with spacing 25 mm		$R_{thJA}$	70	K/W

### Electrical Characteristics

$T_{amb} = 25\text{ }^{\circ}\text{C}$ , unless otherwise specified

Parameter	Test condition	Part	Symbol	Min	Typ.	Max	Unit
Forward voltage	$I_F = 3\text{ A}$		$V_F$			1.0	V
Reverse current	$V_R = V_{RRM}$		$I_R$		0.1	1	$\mu\text{A}$
	$V_R = V_{RRM}$ , $T_J = 100\text{ }^{\circ}\text{C}$		$I_R$		5	10	$\mu\text{A}$
Breakdown voltage	$I_R = 100\text{ }\mu\text{A}$ , $t_p/T = 0.01$ , $t_p = 0.3\text{ ms}$		$V_{(BR)}$			1600	V
Diode capacitance	$V_R = 4\text{ V}$ , $f = 1\text{ MHz}$		$C_D$		40	60	pF
Reverse recovery time	$I_F = 0.5\text{ A}$ , $I_R = 1\text{ A}$ , $i_R = 0.25\text{ A}$		$t_{rr}$		2	4	$\mu\text{s}$
	$I_F = 1\text{ A}$ , $d_i/d_t = 5\text{ A}/\mu\text{s}$ , $V_R = 50\text{ V}$		$t_{rr}$		3	6	$\mu\text{s}$
Reverse recovery charge	$I_F = 1\text{ A}$ , $d_i/d_t = 5\text{ A}/\mu\text{s}$		$Q_{rr}$		6	10	$\mu\text{C}$

### Typical Characteristics ( $T_{amb} = 25\text{ }^{\circ}\text{C}$ unless otherwise specified)

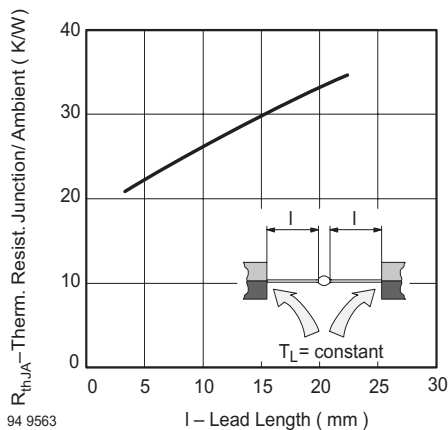

Figure 1. Max. Thermal Resistance vs. Lead Length

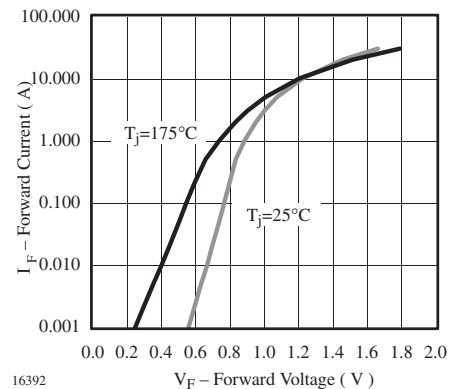

Figure 2. Forward Current vs. Forward Voltage

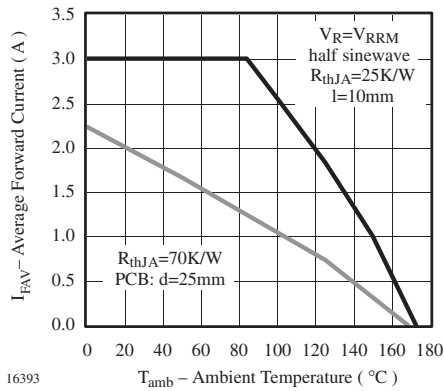

Figure 3. Max. Average Forward Current vs. Ambient Temperature

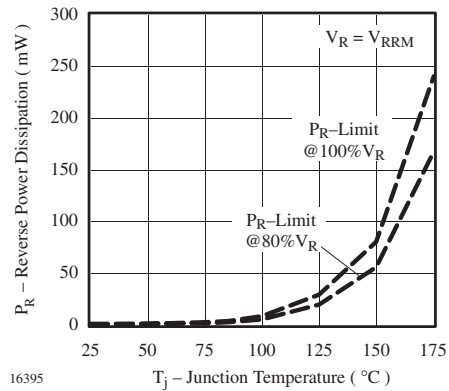

Figure 5. Max. Reverse Power Dissipation vs. Junction Temperature

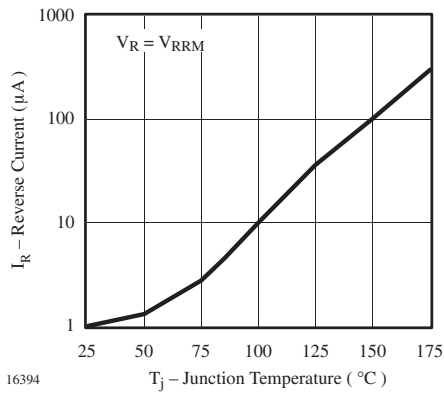

Figure 4. Reverse Current vs. Junction Temperature

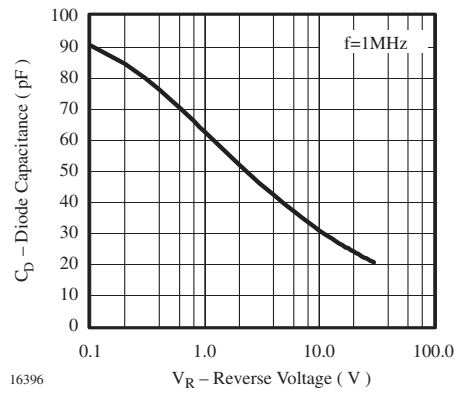
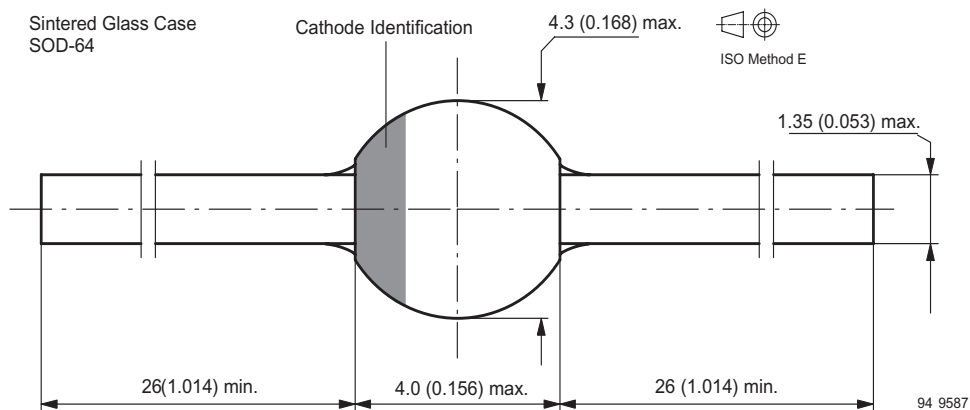

Figure 6. Diode Capacitance vs. Reverse Voltage

## Package Dimensions in mm (Inches)



### Ozone Depleting Substances Policy Statement

It is the policy of Vishay Semiconductor GmbH to

1. Meet all present and future national and international statutory requirements.
2. Regularly and continuously improve the performance of our products, processes, distribution and operating systems with respect to their impact on the health and safety of our employees and the public, as well as their impact on the environment.

It is particular concern to control or eliminate releases of those substances into the atmosphere which are known as ozone depleting substances (ODSs).

The Montreal Protocol (1987) and its London Amendments (1990) intend to severely restrict the use of ODSs and forbid their use within the next ten years. Various national and international initiatives are pressing for an earlier ban on these substances.

Vishay Semiconductor GmbH has been able to use its policy of continuous improvements to eliminate the use of ODSs listed in the following documents.

1. Annex A, B and list of transitional substances of the Montreal Protocol and the London Amendments respectively
2. Class I and II ozone depleting substances in the Clean Air Act Amendments of 1990 by the Environmental Protection Agency (EPA) in the USA
3. Council Decision 88/540/EEC and 91/690/EEC Annex A, B and C (transitional substances) respectively.

Vishay Semiconductor GmbH can certify that our semiconductors are not manufactured with ozone depleting substances and do not contain such substances.

We reserve the right to make changes to improve technical design  
and may do so without further notice.

Parameters can vary in different applications. All operating parameters must be validated for each customer application by the customer. Should the buyer use Vishay Semiconductors products for any unintended or unauthorized application, the buyer shall indemnify Vishay Semiconductors against all claims, costs, damages, and expenses, arising out of, directly or indirectly, any claim of personal damage, injury or death associated with such unintended or unauthorized use.

Vishay Semiconductor GmbH, P.O.B. 3535, D-74025 Heilbronn, Germany



## Disclaimer

All product specifications and data are subject to change without notice.

Vishay Intertechnology, Inc., its affiliates, agents, and employees, and all persons acting on its or their behalf (collectively, "Vishay"), disclaim any and all liability for any errors, inaccuracies or incompleteness contained herein or in any other disclosure relating to any product.

Vishay disclaims any and all liability arising out of the use or application of any product described herein or of any information provided herein to the maximum extent permitted by law. The product specifications do not expand or otherwise modify Vishay's terms and conditions of purchase, including but not limited to the warranty expressed therein, which apply to these products.

No license, express or implied, by estoppel or otherwise, to any intellectual property rights is granted by this document or by any conduct of Vishay.

The products shown herein are not designed for use in medical, life-saving, or life-sustaining applications unless otherwise expressly indicated. Customers using or selling Vishay products not expressly indicated for use in such applications do so entirely at their own risk and agree to fully indemnify Vishay for any damages arising or resulting from such use or sale. Please contact authorized Vishay personnel to obtain written terms and conditions regarding products designed for such applications.

Product names and markings noted herein may be trademarks of their respective owners.