



AS116

Low Dropout Voltage Three Terminal Regulator

FEATURES

- 3.5V, 3.3V, 3.0V and Adjustable Versions Available
- Very Low Dropout Voltage
- Output Current In Excess Of 100mA
- Low Standby Current (ON, No Load)
- Short Circuit Protection
- Internal Thermal Shutdown
- Available in TO-92, SO-8 & SO-89 Packages
- Direct Replacement Pin to Pin to TK116

APPLICATIONS

- Battery Powered Systems
- Cordless Telephones
- Radio Control Systems
- Portable/ Palm Top / Notebook Computers
- Portable Consumer Equipment
- Portable Instrumentation
- Pager
- Low Voltage Systems
- Cellular Phone

PRODUCT DESCRIPTION

The AS116 is a low power voltage regulators. This devices are an excellent choice for use in battery-powered applications such as cordless telephones, radio control systems, and pagers. The AS116 features very low quiescent current in ON (400µA no load and 2mA at 60mA load) and OFF mode and very low dropout voltage of less than 200mV at 80mA load through internal PNP pass-transistor. The junction temperature of 150°C is achieved through an internal thermal shutdown. In case of short circuit, the AS116 will shut down.

This device is available in 3.0V, 3.3V and 3.5V output voltages. This regulator is available in TO-92, SO-8 and SOT-89 packages, it can also be supplied in tape and reel. The AS116 is a direct replacement to TK116.

ORDERING INFORMATION

TO-92	SO-8	SOT-89 3-PIN	Oper. Temp. Range
AS116N-XX	AS116S-XX	AS116M1-XX	IND.

PIN CONNECTIONS

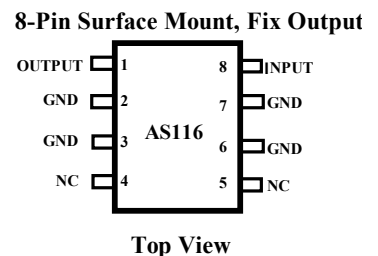
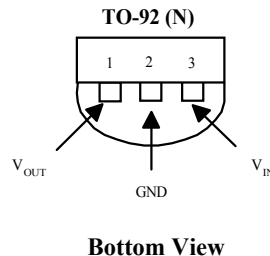
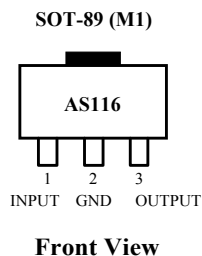

ABSOLUTE MAXIMUM RATINGS

Power Dissipation.....500 mW
 Lead Temp. (Soldering, 5 Seconds)..... 240°C
 Storage Temperature Range -65° to +150°C
 Operating Junction Temperature Range
 AS116..... +150°C

Input Supply Voltage -20 to +60V
 Feedback Input Voltage -1.5 to +30V
 Shutdown Input Voltage..... -0.3 to +30V
 Output Voltage..... $V_{OUT} \times 1.15$ V
 Load Current 180 mA

ELECTRICAL CHARACTERISTICS at Ta=25°C, unless otherwise specified.

Parameter	Symbol	Test Conditions	Min	Typ	Max	Units
Supply Voltage Range	V_{IN}		2.5		14	V
Supply Current	I_{IN1}	$I_{OUT}=0mA, V_{CONT}=0, ON Mode$		400		μA
Supply Current	I_{IN2}	$V_{CONT}=V_{IN}, OFF Mode$		800		μA
Regulated Output Voltage	V_{OUT}	$V_{IN}=V_{OUT} + 1 V, I_{OUT}=10mA$	-3.0	V_{OUT}	+3.0	%
Dropout voltage	V_{DROPI}	$I_{OUT}=10mA$		50		mV
Dropout Voltage	V_{DROPII}	$I_{OUT}=60mA$		170		mV
Output Current	I_{OUT}		100			mA
Line Regulation	LI_{REG}	$V_{OUT}+1.0V$ to $\leq V_{IN} \leq V_{OUT}+6.0V$		0.01		%/V
Load Regulation	LD_{REG}	$10 mA \leq I_{OUT} \leq 60mA, V_{IN}=V_{OUT}+1.5$		0.02		%/mA
Ripple Rejection	V_{RIPPLE}	$100mV_{RMS}, f=400Hz$ $V_{IN}=V_{OUT}+1.5V, I_{OUT}=10mA$		55		dB
Output Voltage Temperature Coefficient	$\Delta V_{OUT} / \Delta T_A$	$0^{\circ}C \leq T_A \leq 75^{\circ}C$ $V_{IN}=V_{OUT}+1.5V, I_{OUT}=10mA$		± 0.2		mV/°C
Output Noise Voltage	V_N	$V_{IN}=V_{OUT}+1.5V, I_{OUT}=10mA$ $10Hz < f < 100kHz, I_{OUT}=10mA$		150		μV_{RMS}

TEST CIRCUIT

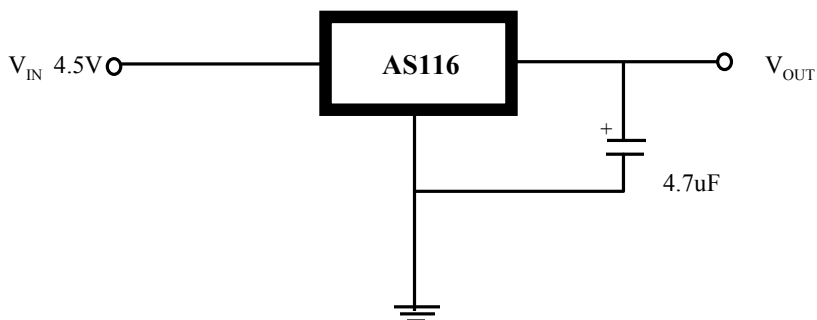

TYPICAL CHARACTERISTICS

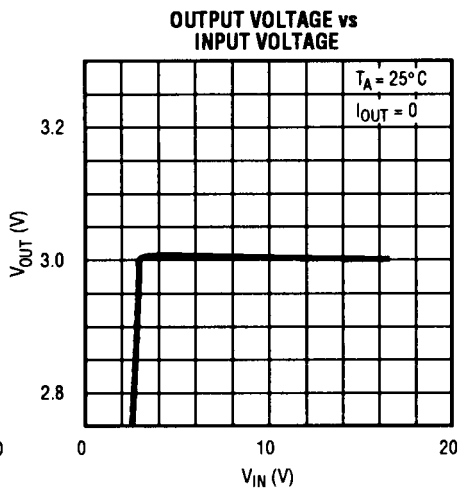
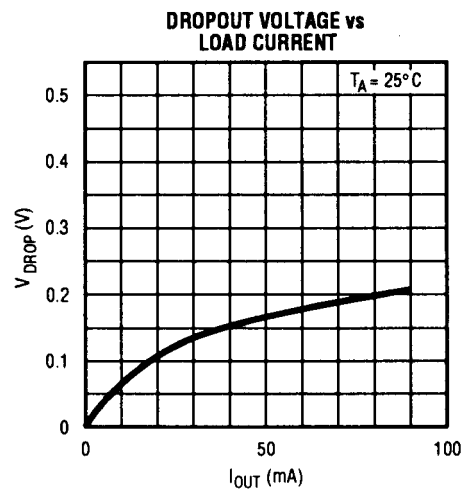
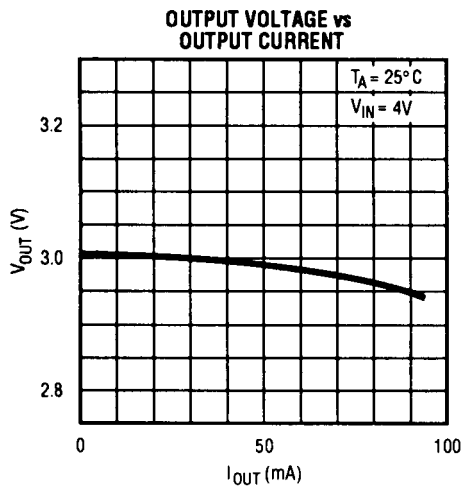
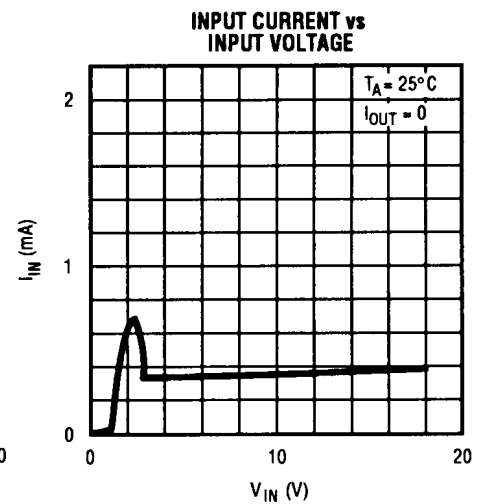
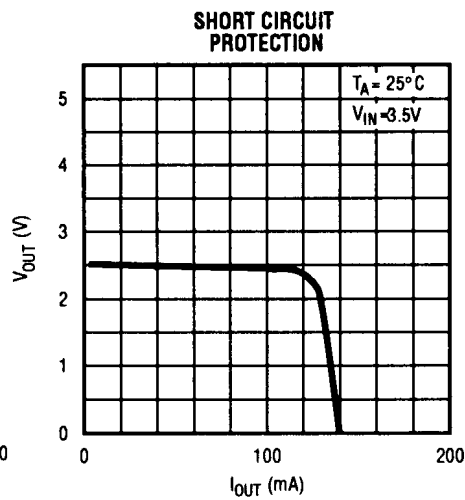
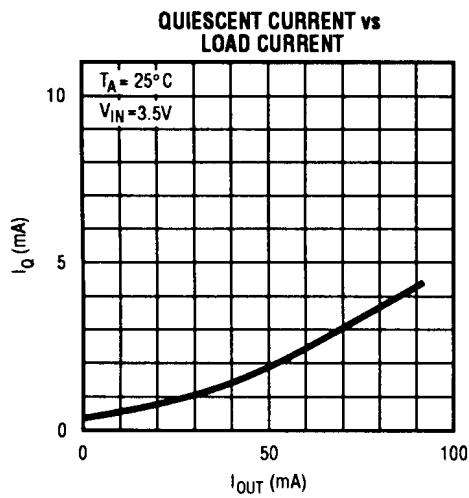
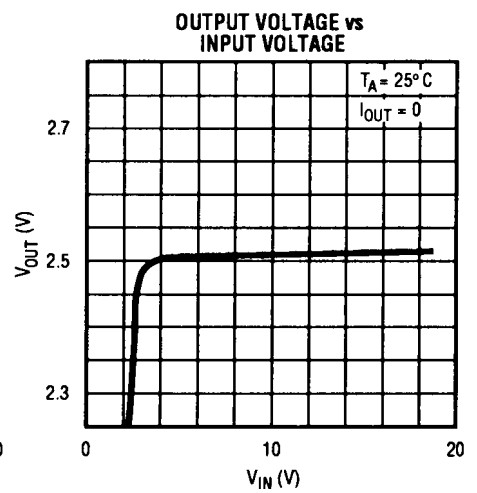
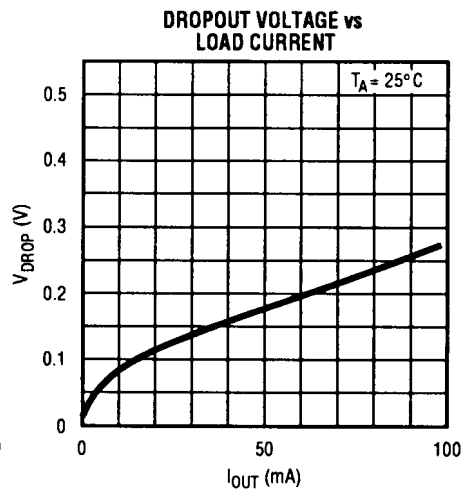
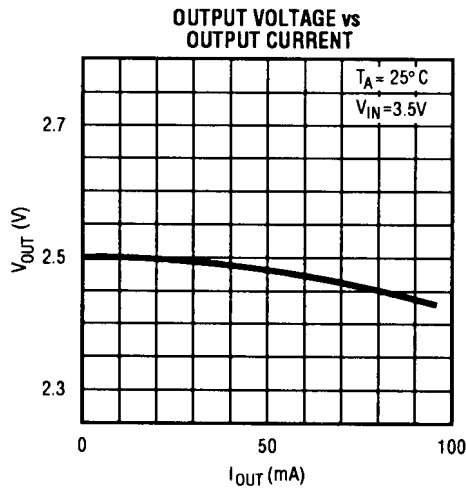

TYPICAL CHARACTERISTICS

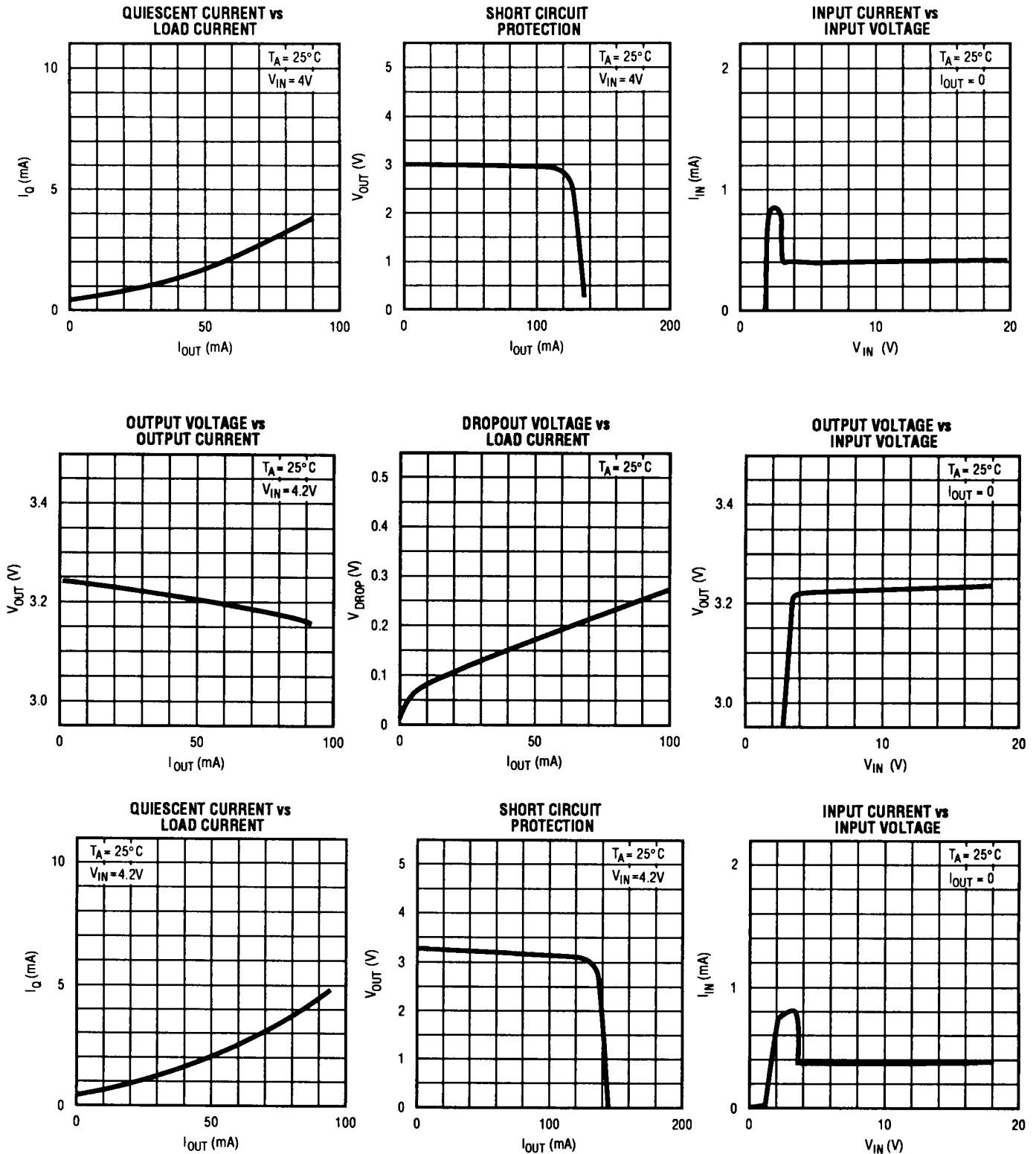

TYPICAL CHARACTERISTICS

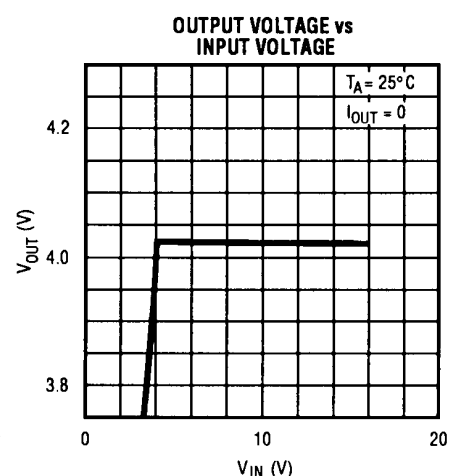
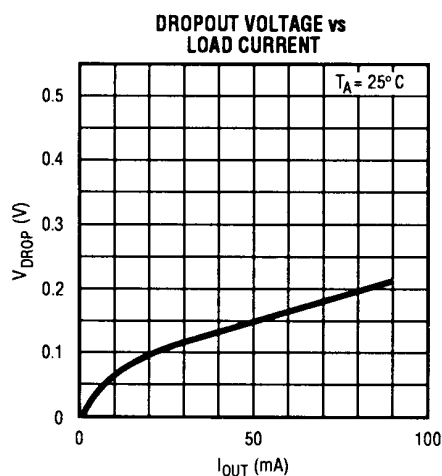
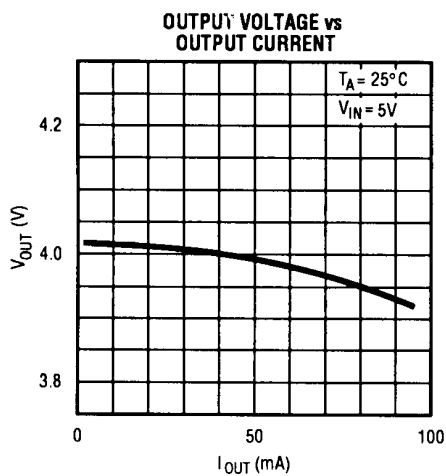
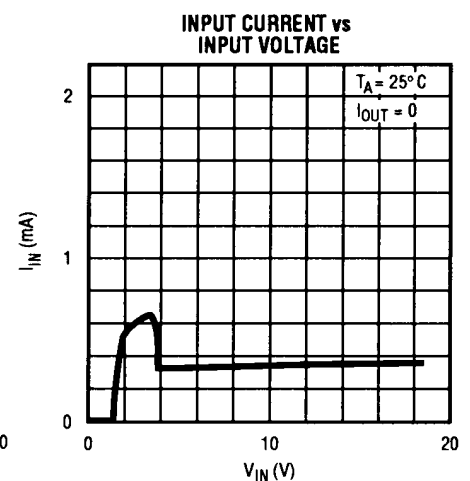
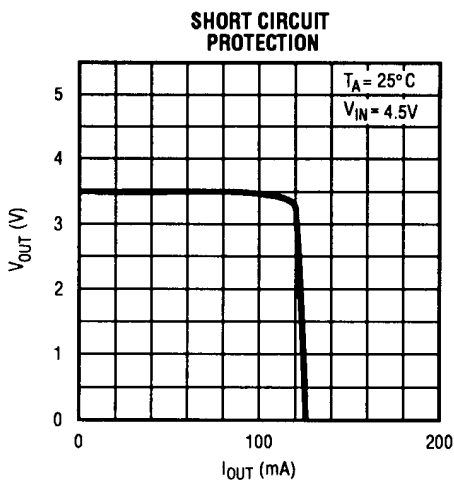
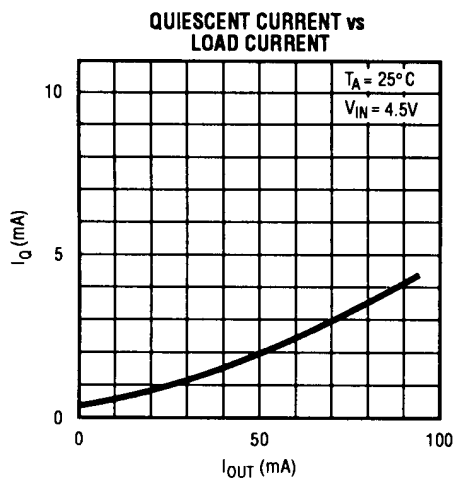
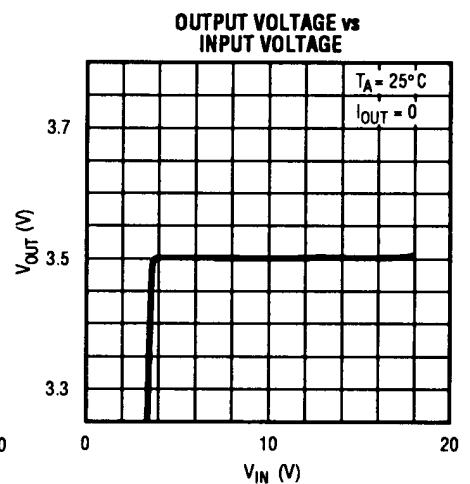
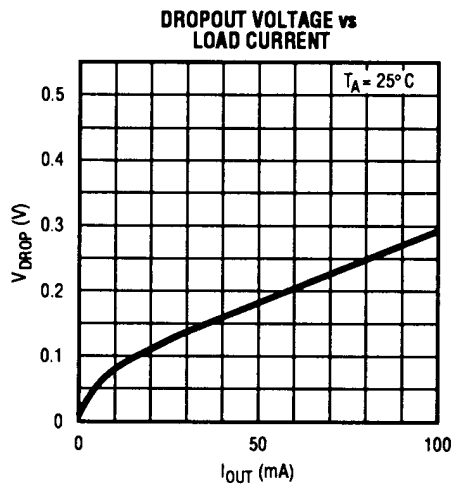
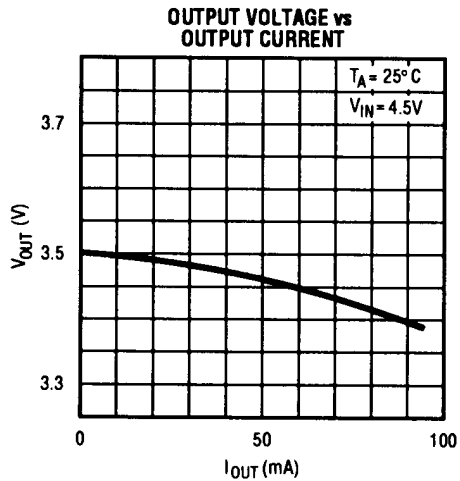

TYPICAL CHARACTERISTICS

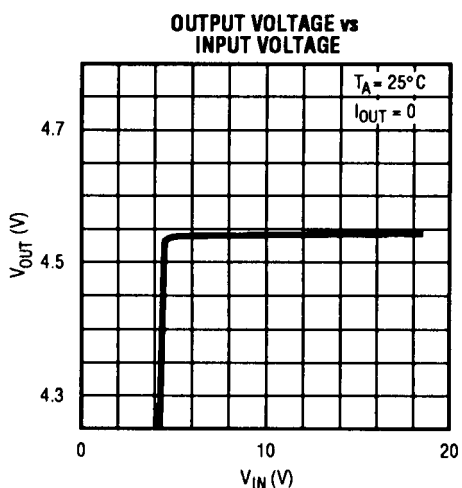
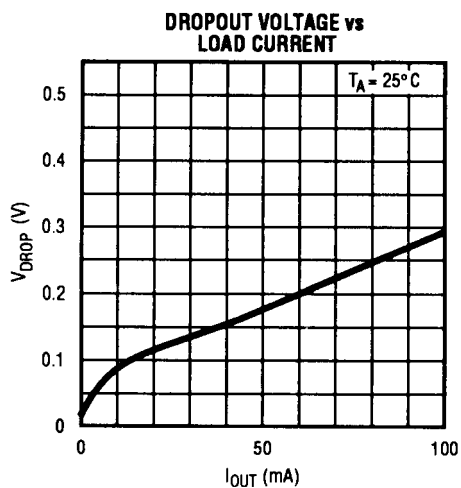
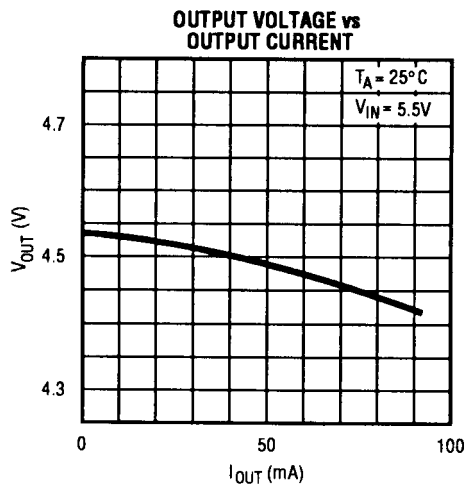
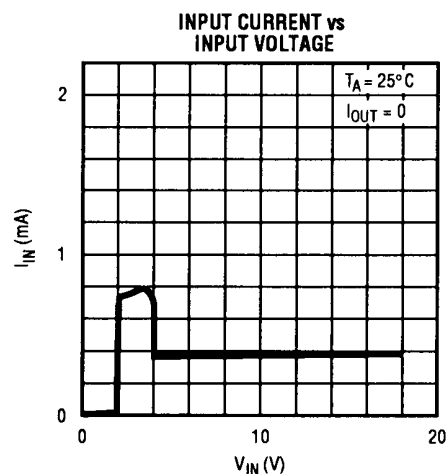
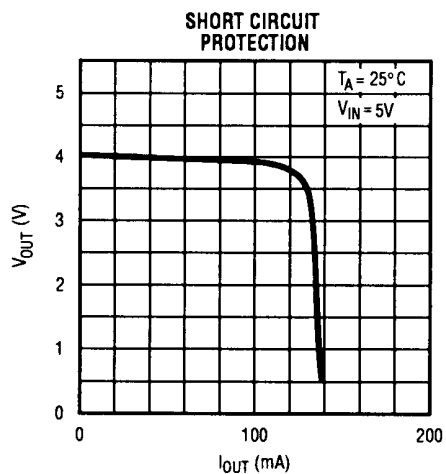
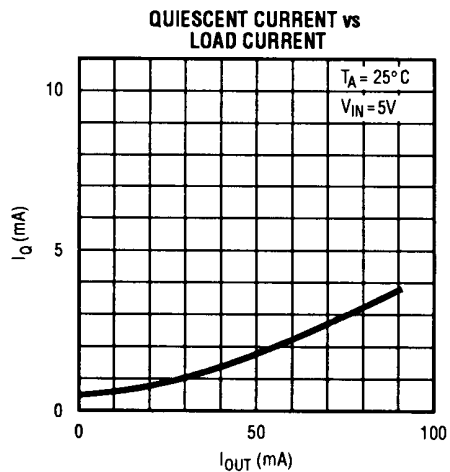

TYPICAL CHARACTERISTICS

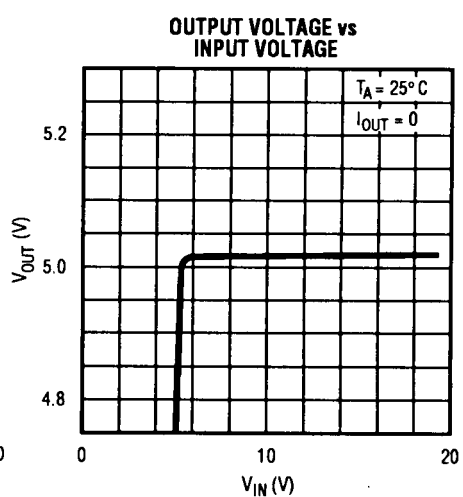
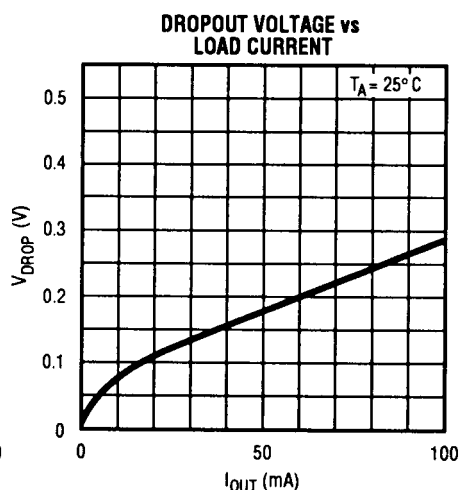
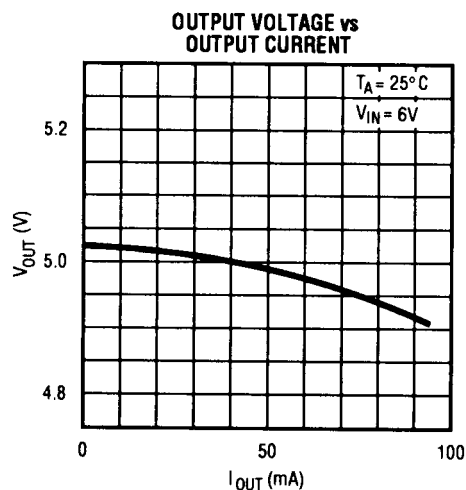
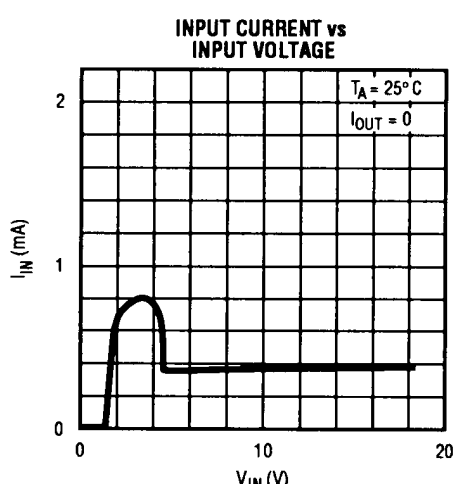
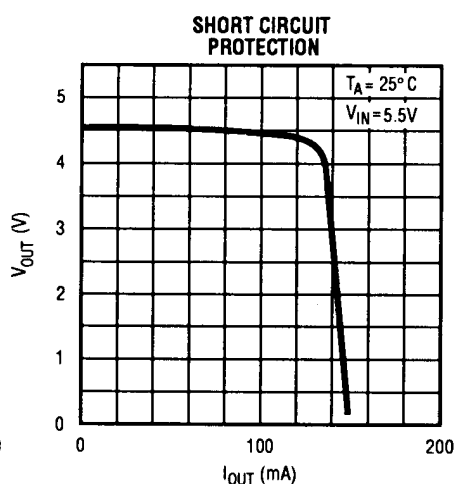
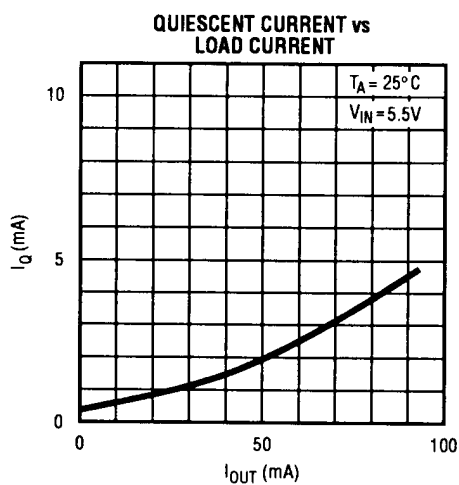

TYPICAL CHARACTERISTICS

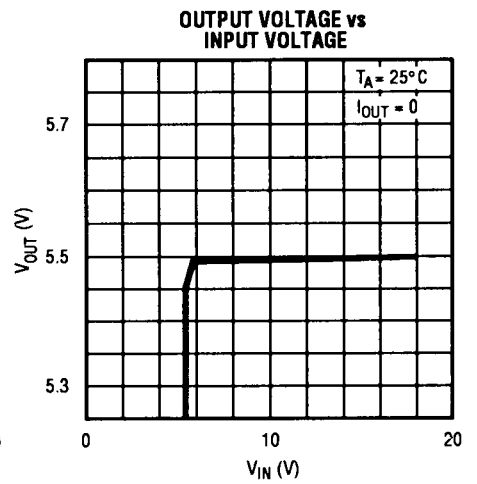
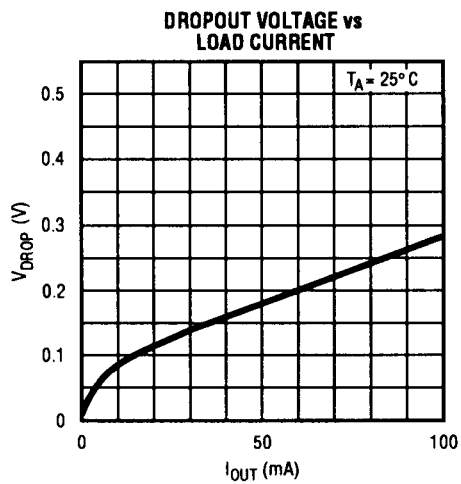
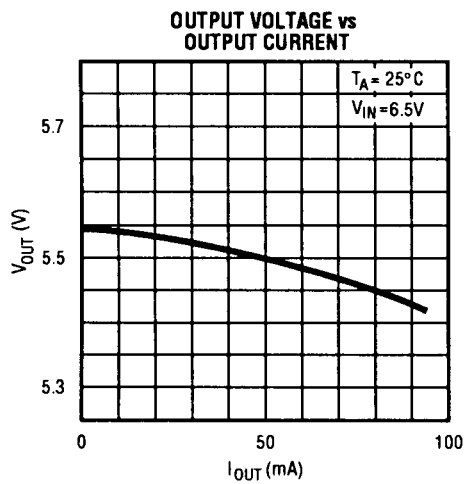
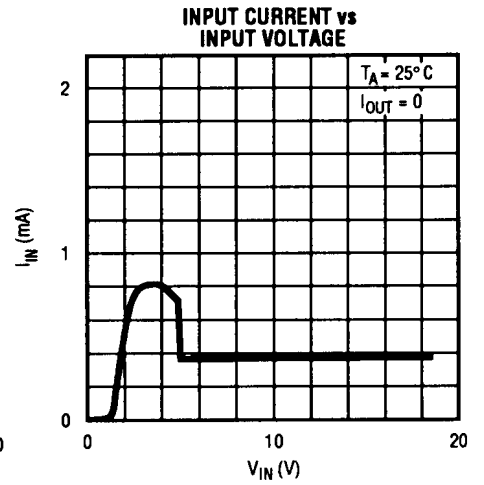
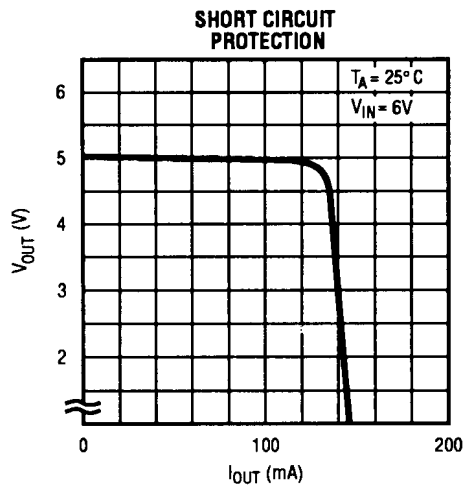
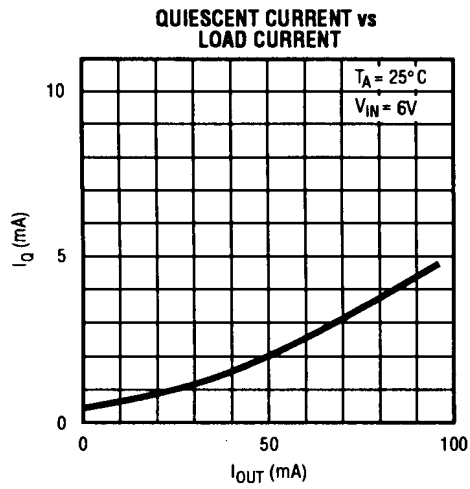

TYPICAL CHARACTERISTICS

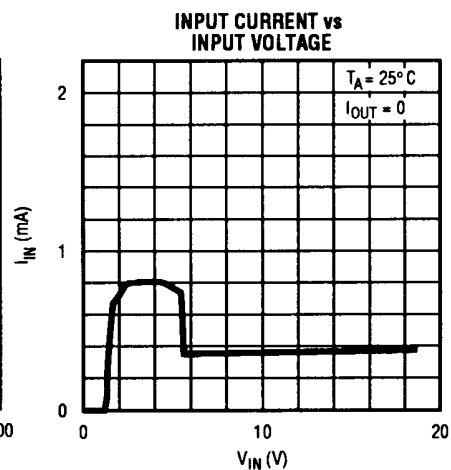
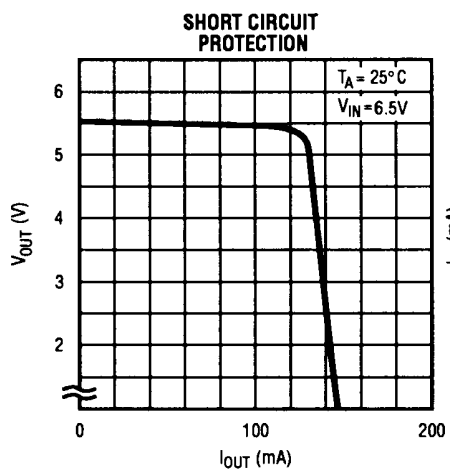
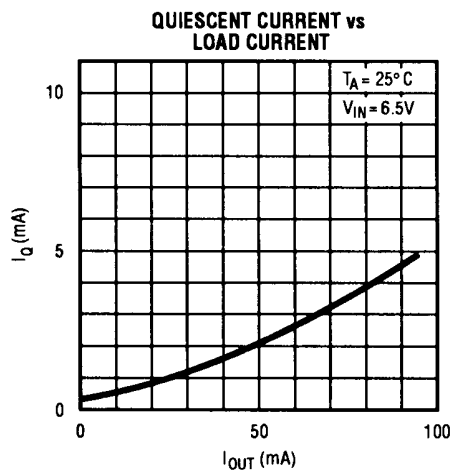

AS116 Adjustable Output

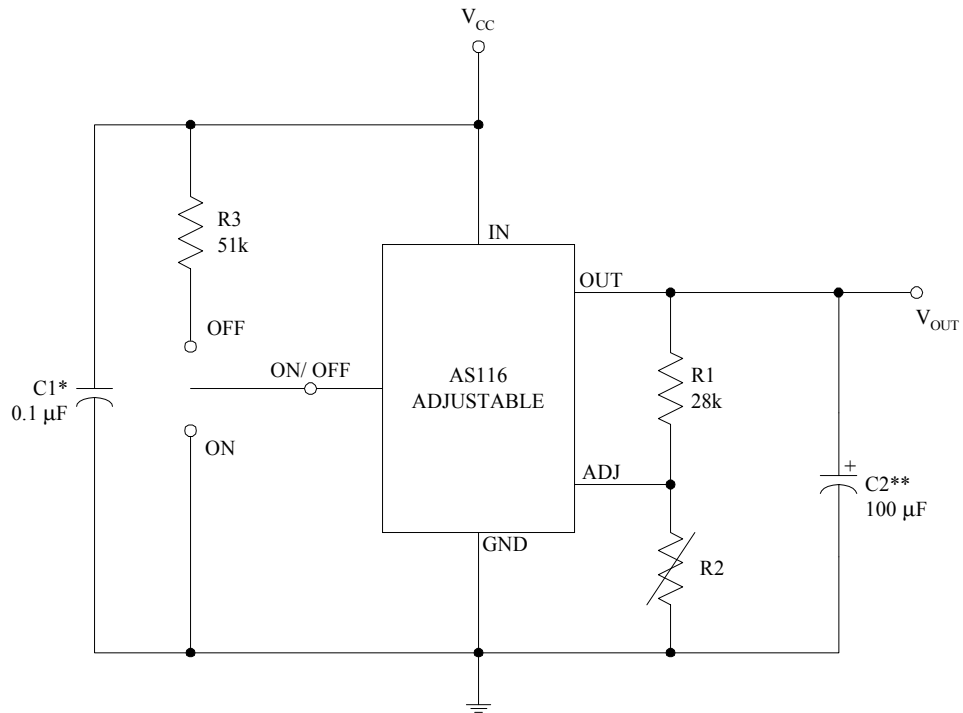

$$V_{OUT} = \text{Reference Voltage} \times \frac{R1 + R2}{R1}$$

Note: Using 27K for R1 will automatically compensate for errors in V_{OUT} due to the input bias current of the ADJ pin (approximately $1\mu A$).