



## 12 GHz Silicon NPN Planar RF Transistor

### Features

- Low power applications
- Very low noise figure
- High transition frequency  $f_T = 12$  GHz
- Lead (Pb)-free component
- Component in accordance to RoHS 2002/95/EC and WEEE 2002/96/EC



### Applications

For low noise applications such as preamplifiers, mixers and oscillators in analog and digital TV-systems (e.g., satellite tuners) up to microwave frequencies.

### Mechanical Data

**Typ:** TSDF1220

**Case:** SOT143 Plastic case

**Weight:** approx. 8.0 mg

**Pinning:** 1 = Collector, 2 = Emitter, 3 = Base, 4 = Emitter

**Typ:** TSDF1220R

**Case:** SOT143R Plastic case

**Weight:** approx. 8.0 mg

**Pinning:** 1 = Collector, 2 = Emitter, 3 = Base, 4 = Emitter

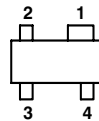

SOT-143

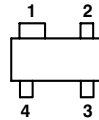
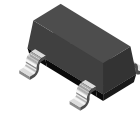

SOT-143R

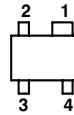
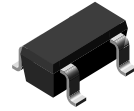

SOT-343

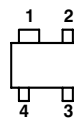
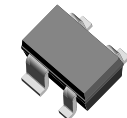

SOT-343R

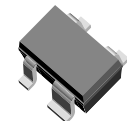

Electrostatic sensitive device.  
Observe precautions for handling.

13629

**Typ:** TSDF1220W

**Case:** SOT343 Plastic case

**Weight:** approx. 6.0 mg

**Pinning:** 1 = Collector, 2 = Emitter, 3 = Base, 4 = Emitter

**Typ:** TSDF1220RW

**Case:** SOT343R Plastic case

**Weight:** approx. 6.0 mg

**Pinning:** 1 = Collector, 2 = Emitter, 3 = Base, 4 = Emitter

### Parts Table

Part	Ordering Code	Type Marking	Remarks
TSDF1220	TSDF1220-GS08	F20	Tape and Reel
TSDF1220R	TSDF1220R-GS08	20F	Tape and Reel
TSDF1220RW	TSDF1220RW-GS08	W2F	Tape and Reel
TSDF1220W	TSDF1220W-GS08	WF2	Tape and Reel

### Absolute Maximum Ratings

$T_{amb} = 25\text{ }^{\circ}\text{C}$ , unless otherwise specified

Parameter	Test condition	Symbol	Value	Unit
Collector-base voltage		$V_{CBO}$	9	V
Collector-emitter voltage		$V_{CEO}$	6	V
Emitter-base voltage		$V_{EBO}$	2	V
Collector current		$I_C$	40	mA
Total power dissipation	$T_{amb} \leq 60\text{ }^{\circ}\text{C}$	$P_{tot}$	200	mW
Junction temperature		$T_j$	150	$^{\circ}\text{C}$
Storage temperature range		$T_{stg}$	- 65 to + 150	$^{\circ}\text{C}$

### Maximum Thermal Resistance

Parameter	Test condition	Symbol	Value	Unit
Junction to ambient air	1)	$R_{thJA}$	450	K/W

1) on glass fibre printed board (25 x 20 x 1.5) mm<sup>3</sup> plated with 35  $\mu\text{m}$  Cu

### Electrical DC Characteristics

$T_{amb} = 25\text{ }^{\circ}\text{C}$ , unless otherwise specified

Parameter	Test condition	Symbol	Min	Typ.	Max	Unit
Collector-emitter cut-off current	$V_{CE} = 12\text{ V}, V_{BE} = 0$	$I_{CES}$			100	$\mu\text{A}$
Collector-base cut-off current	$V_{CB} = 10\text{ V}, I_E = 0$	$I_{CBO}$			100	nA
Emitter-base cut-off current	$V_{EB} = 1\text{ V}, I_C = 0$	$I_{EBO}$			2	$\mu\text{A}$
Collector-emitter breakdown voltage	$I_C = 1\text{ mA}, I_B = 0$	$V_{(BR)CEO}$	6			V
Collector-emitter saturation voltage	$I_C = 30\text{ mA}, I_B = 3\text{ mA}$	$V_{CEsat}$		0.1	0.5	V
DC forward current transfer ratio	$V_{CE} = 5\text{ V}, I_C = 20\text{ mA}$	$h_{FE}$	50	100	150	

### Electrical AC Characteristics

$T_{amb} = 25\text{ }^{\circ}\text{C}$ , unless otherwise specified

Parameter	Test condition	Symbol	Min	Typ.	Max	Unit
Transition frequency	$V_{CE} = 5\text{ V}, I_C = 20\text{ mA}, f = 1\text{ GHz}$	$f_T$		12		GHz
Collector-base capacitance	$V_{CB} = 1\text{ V}, f = 1\text{ MHz}$	$C_{cb}$		0.3		pF
Collector-emitter capacitance	$V_{CE} = 1\text{ V}, f = 1\text{ MHz}$	$C_{ce}$		0.35		pF
Emitter-base capacitance	$V_{EB} = 0.5\text{ V}, f = 1\text{ MHz}$	$C_{eb}$		0.5		pF
Noise figure	$V_{CE} = 5\text{ V}, I_C = 3\text{ mA}, Z_S = Z_{Sopt}, Z_L = 50\ \Omega, f = 2\text{ GHz}$	F		1.2		dB
Power gain	$V_{CE} = 5\text{ V}, I_C = 20\text{ mA}, Z_S = Z_{Sopt}, Z_L = 50\ \Omega, f = 2\text{ GHz}$	$G_{pe}$		14		dB
Transducer gain	$V_{CE} = 5\text{ V}, I_C = 20\text{ mA}, Z_0 = 50\ \Omega, f = 2\text{ GHz}$	$ S_{21e} ^2$		12.5		dB
Third order intercept point at output	$V_{CE} = 5\text{ V}, I_C = 20\text{ mA}, f = 2\text{ GHz}$	$IP_3$		22		dBm



## Typical Characteristics

$T_{amb} = 25\text{ }^{\circ}\text{C}$  unless otherwise specified

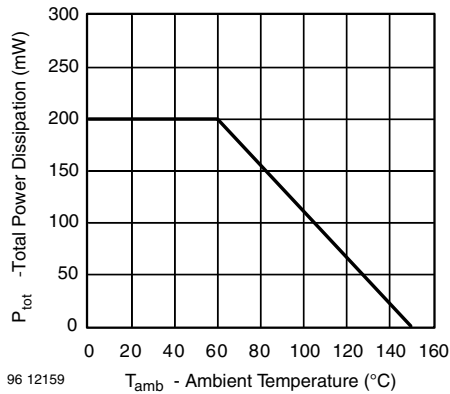

Figure 1. Total Power Dissipation vs. Ambient Temperature

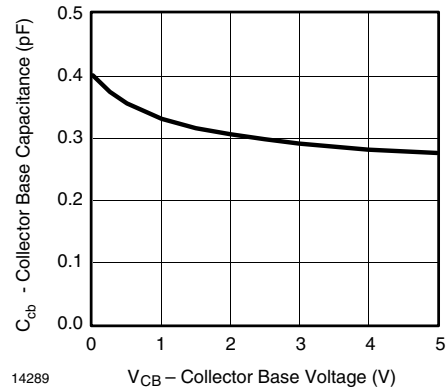

Figure 3. Collector Base Capacitance vs. Collector Base Voltage

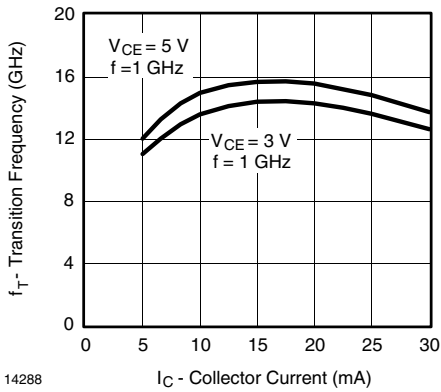

Figure 2. Transition Frequency vs. Collector Current

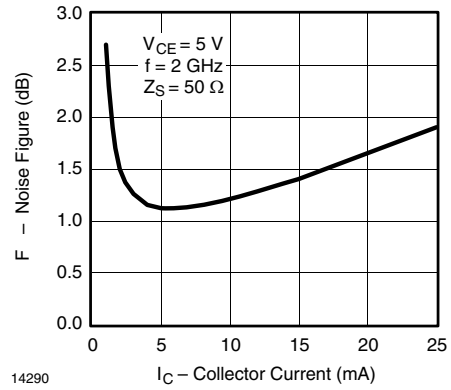

Figure 4. Noise Figure vs. Collector Current

# TSDF1220 / 1220R / 1220W / 1220RW



Vishay Semiconductors

## Package Dimensions in mm (Inches): SOT143

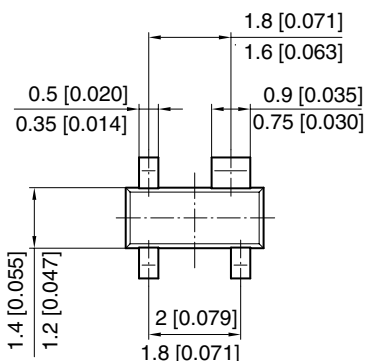
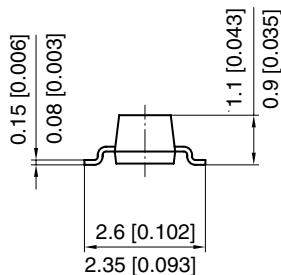
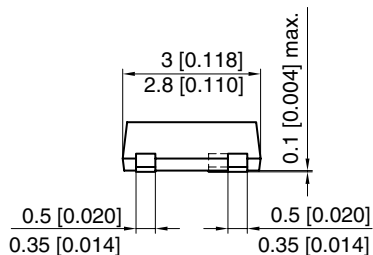

foot print recommendation:

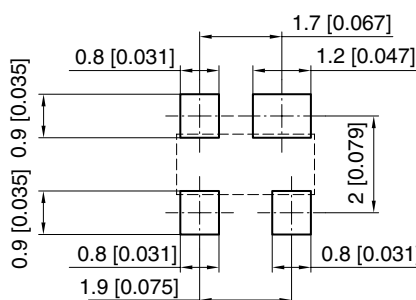

9612240  
Rev. 5 - Date: 25.January.2005  
Document no.:6.541-5015.01-4

## Package Dimensions in mm (Inches): SOT143R

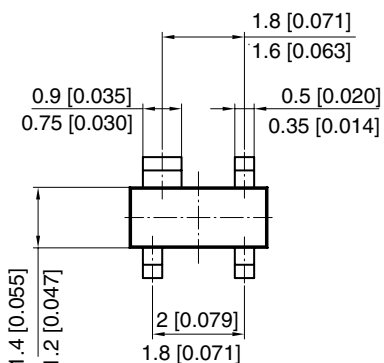
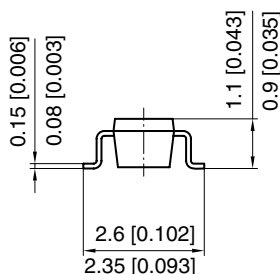
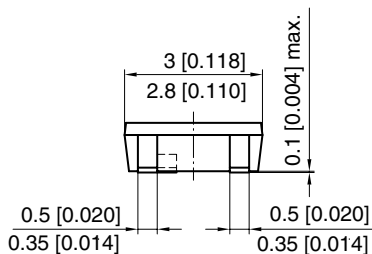

foot print recommendation:

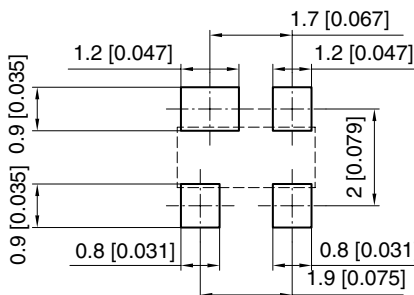

9612239  
Rev. 5 - Date: 25.January.2005  
Document no.:6.541-5016.01-4



# TSD1220 / 1220R / 1220W / 1220RW

Vishay Semiconductors

## Package Dimensions in mm (Inches): SOT343

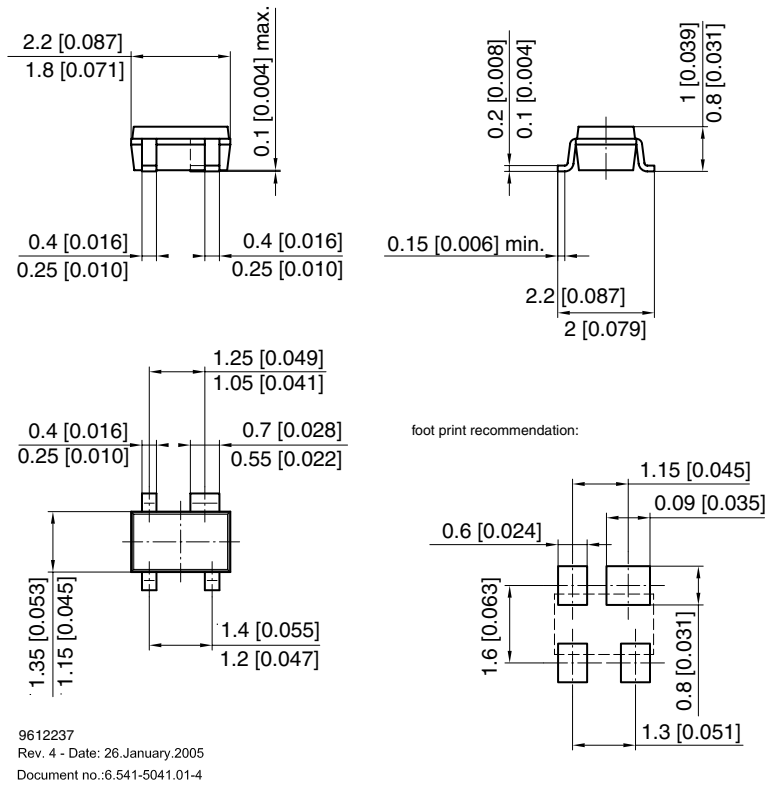

## Package Dimensions in mm (Inches): SOT343R

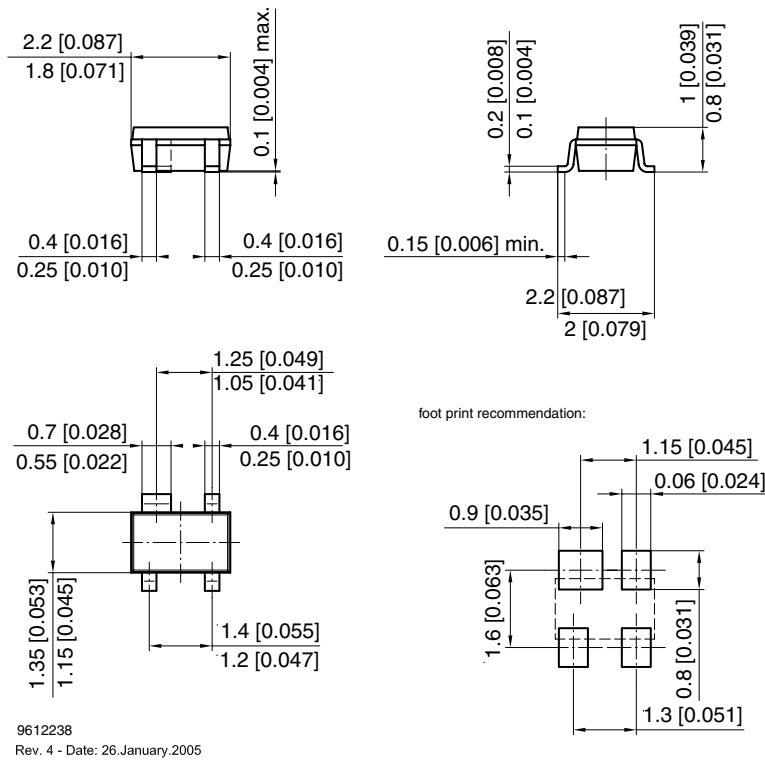

### Ozone Depleting Substances Policy Statement

It is the policy of Vishay Semiconductor GmbH to

1. Meet all present and future national and international statutory requirements.
2. Regularly and continuously improve the performance of our products, processes, distribution and operating systems with respect to their impact on the health and safety of our employees and the public, as well as their impact on the environment.

It is particular concern to control or eliminate releases of those substances into the atmosphere which are known as ozone depleting substances (ODSs).

The Montreal Protocol (1987) and its London Amendments (1990) intend to severely restrict the use of ODSs and forbid their use within the next ten years. Various national and international initiatives are pressing for an earlier ban on these substances.

Vishay Semiconductor GmbH has been able to use its policy of continuous improvements to eliminate the use of ODSs listed in the following documents.

1. Annex A, B and list of transitional substances of the Montreal Protocol and the London Amendments respectively
2. Class I and II ozone depleting substances in the Clean Air Act Amendments of 1990 by the Environmental Protection Agency (EPA) in the USA
3. Council Decision 88/540/EEC and 91/690/EEC Annex A, B and C (transitional substances) respectively.

Vishay Semiconductor GmbH can certify that our semiconductors are not manufactured with ozone depleting substances and do not contain such substances.

We reserve the right to make changes to improve technical design  
and may do so without further notice.

Parameters can vary in different applications. All operating parameters must be validated for each customer application by the customer. Should the buyer use Vishay Semiconductors products for any unintended or unauthorized application, the buyer shall indemnify Vishay Semiconductors against all claims, costs, damages, and expenses, arising out of, directly or indirectly, any claim of personal damage, injury or death associated with such unintended or unauthorized use.

Vishay Semiconductor GmbH, P.O.B. 3535, D-74025 Heilbronn, Germany



### Notice

Specifications of the products displayed herein are subject to change without notice. Vishay Intertechnology, Inc., or anyone on its behalf, assumes no responsibility or liability for any errors or inaccuracies.

Information contained herein is intended to provide a product description only. No license, express or implied, by estoppel or otherwise, to any intellectual property rights is granted by this document. Except as provided in Vishay's terms and conditions of sale for such products, Vishay assumes no liability whatsoever, and disclaims any express or implied warranty, relating to sale and/or use of Vishay products including liability or warranties relating to fitness for a particular purpose, merchantability, or infringement of any patent, copyright, or other intellectual property right.

The products shown herein are not designed for use in medical, life-saving, or life-sustaining applications. Customers using or selling these products for use in such applications do so at their own risk and agree to fully indemnify Vishay for any damages resulting from such improper use or sale.