

## Turbo 2 ultrafast high voltage rectifier

Datasheet – production data

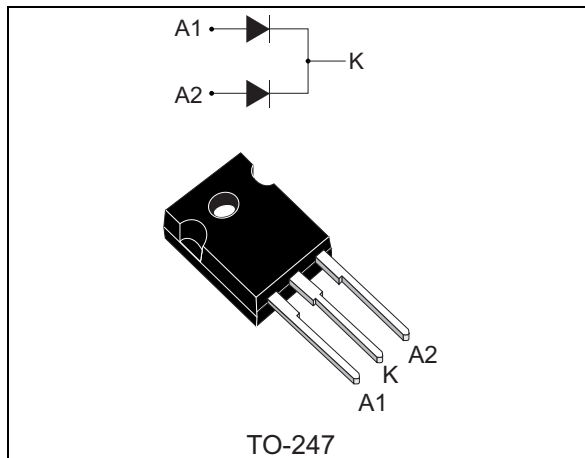

### Description

The STTH60SW03C uses ST Turbo 2 300 V technology. It is especially suited to be used for DC/DC and DC/AC converters in the secondary stage of MIG/MMA/TIG welding machines.

Housed in ST's TO-247, this device offers high power integration for all welding machines and industrial applications.

**Table 1. Device summary**

Symbol	Value
$I_{F(AV)}$	2 x 30A
$V_{RRM}$	300 V
$t_{rr}$ (typ)	20 ns
$V_F$ (typ)	1.05 V
$T_j$ (max)	175 °C

### Features

- Ultrafast switching
- Low reverse recovery current
- Reduces switching losses
- Low thermal resistance
- ECOPACK<sup>®</sup>2 compliant component

# 1 Characteristics

**Table 2. Absolute ratings (limiting values per diode at 25 °C, unless otherwise specified)**

Symbol	Parameter			Value	Unit
$V_{RRM}$	Repetitive peak reverse voltage			300	V
$I_{F(RMS)}$	Forward rms current			45	A
$I_{F(AV)}$	Average forward current, $\delta = 0.5$ square waveform	$T_C = 85\text{ °C}$	Per diode	30	A
		$T_C = 75\text{ °C}$	Per device	60	
$I_{FSM}$	Surge non repetitive forward current		$t_p = 10\text{ ms}$ sinusoidal	200	A
$T_{stg}$	Storage temperature range			-65 to +175	°C
$T_j$	Maximum operating junction temperature			175	°C

**Table 3. Thermal parameters**

Symbol	Parameter		Value	Unit
$R_{th(j-c)}$	Junction to case	Per diode	1.8	°C/W
		Total	1	
$R_{th(c)}$	Coupling		0.2	

When diodes 1 and 2 are used simultaneously:

$$T_{j(diode1)} = P_{(diode1)} \times R_{th(j-c)}(\text{per diode}) + P_{(diode2)} \times R_{th(c)}$$

**Table 4. Static electrical characteristics (per diode)**

Symbol	Parameter	Test conditions		Min.	Typ.	Max.	Unit
$I_R^{(1)}$	Reverse leakage current	$T_j = 25\text{ °C}$	$V_R = V_{RRM}$			15	$\mu\text{A}$
		$T_j = 125\text{ °C}$			15	150	
$V_F^{(2)}$	Forward voltage drop	$T_j = 25\text{ °C}$	$I_F = 30\text{ A}$			1.55	V
		$T_j = 150\text{ °C}$			1.05	1.25	
		$T_j = 25\text{ °C}$	$I_F = 60\text{ A}$			1.85	
		$T_j = 150\text{ °C}$			1.35	1.6	

1. Pulse test:  $t_p = 5\text{ ms}$ ,  $\delta < 2\%$

2. Pulse test:  $t_p = 380\text{ }\mu\text{s}$ ,  $\delta < 2\%$

To evaluate the conduction losses use the following equation:

$$P = 0.89 \times I_{F(AV)} + 0.012 I_{F(RMS)}^2$$

Table 5. Recovery characteristics (per diode)

Symbol	Parameter	Test conditions		Min.	Typ.	Max.	Unit
$t_{rr}$	Reverse recovery time	$T_j = 25\text{ }^\circ\text{C}$	$I_F = 1\text{ A}, V_R = 30\text{ V},$ $di_F/dt = -100\text{ A}/\mu\text{s}$		20	27	ns
$I_{RM}$	Reverse recovery current	$T_j = 125\text{ }^\circ\text{C}$	$I_F = 30\text{ A}, V_R = 200\text{ V},$ $di_F/dt = -200\text{ A}/\mu\text{s}$		7	9	A
$Q_{rr}$	Reverse recovery charge				190		nC
$S_{factor}$	Softness factor				0.3		
$t_{fr}$	Forward recovery time	$T_j = 25\text{ }^\circ\text{C}$	$I_F = 30\text{ A}, V_{FR} = 1.6\text{ V},$ $di_F/dt = +400\text{ A}/\mu\text{s}$			180	ns
$V_{FP}$	Forward recovery voltage				3.5	5	V

Figure 1. Average forward power dissipation versus average forward current (per diode)

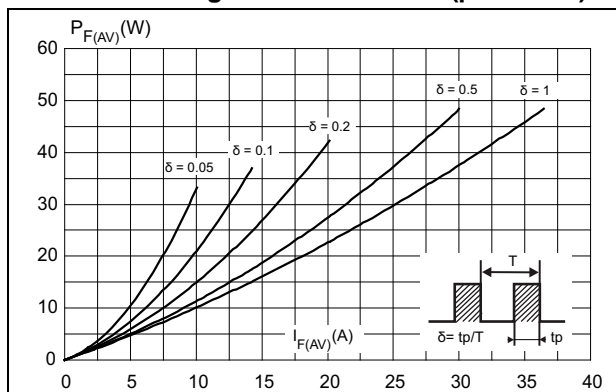

Figure 2. Forward voltage drop versus forward current (typical values, per diode)

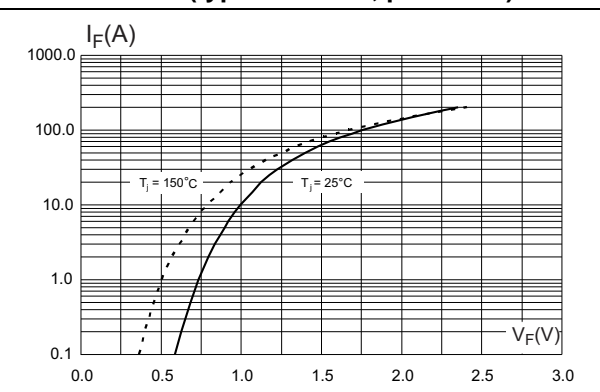

Figure 3. Forward voltage drop versus forward current (maximum values, per diode)

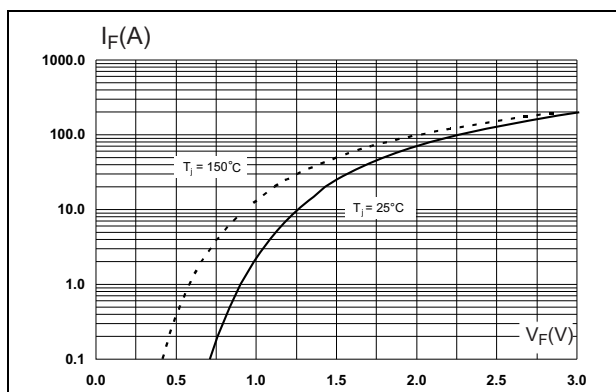

Figure 4. Relative variation of thermal impedance, junction to case, versus pulse duration

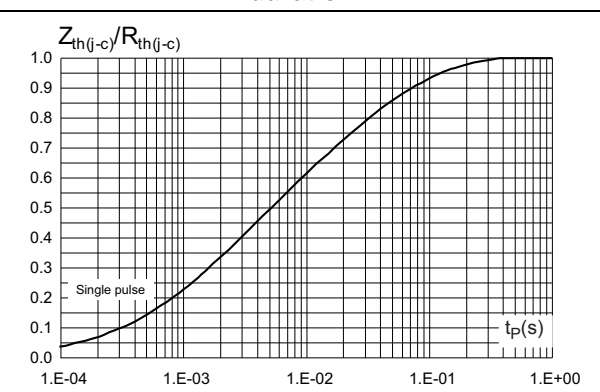

Figure 5. Peak reverse recovery current versus  $di_F/dt$  (typical values, per diode)

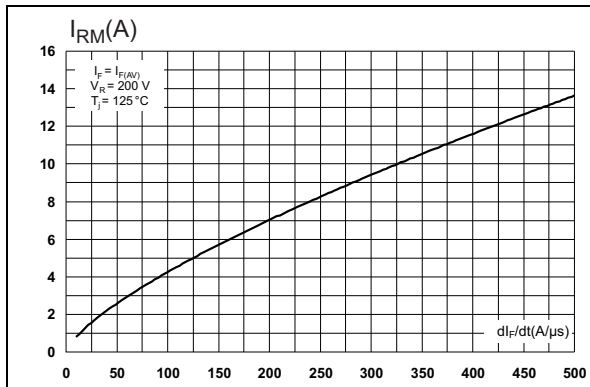

Figure 6. Reverse recovery time versus  $di_F/dt$  (typical values, per diode)

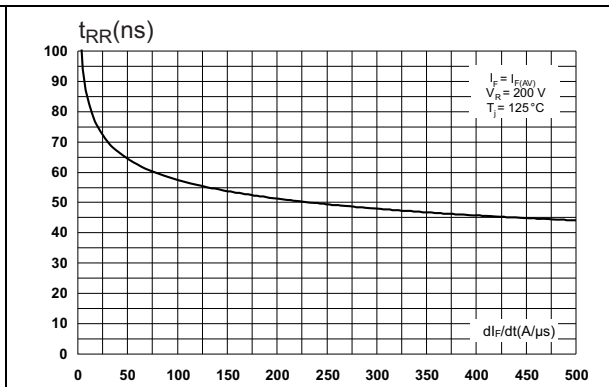

Figure 7. Reverse recovery charges versus  $di_F/dt$  (typical values, per diode)

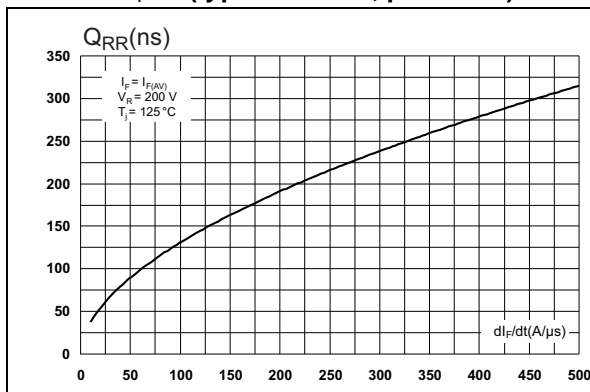

Figure 8. Reverse recovery softness factor versus  $di_F/dt$  (typical values, per diode)

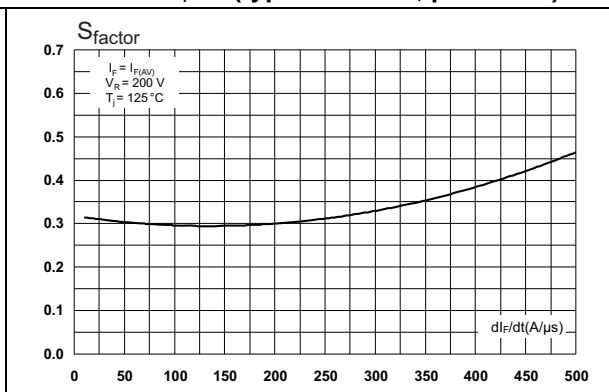

Figure 9. Relative variations of dynamic parameters versus junction temperature

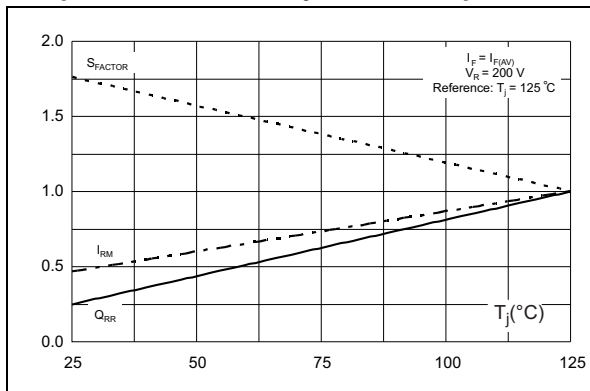

Figure 10. Transient peak forward voltage versus  $di_F/dt$  (typical values, per diode)

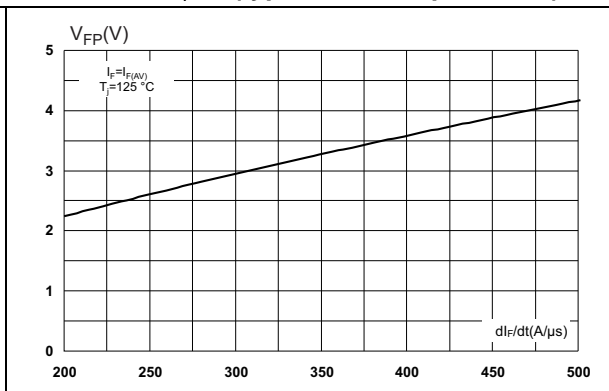

Figure 11. Forward recovery time versus  $di_F/dt$  (typical values, per diode)

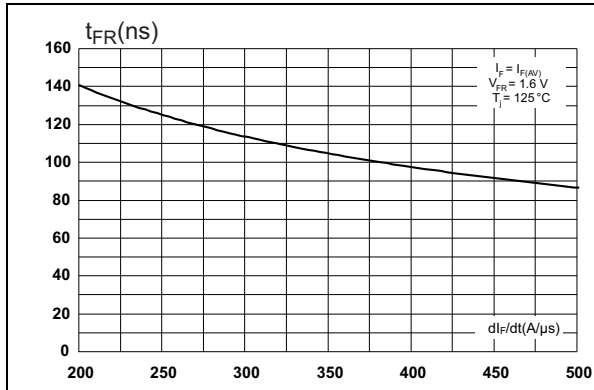
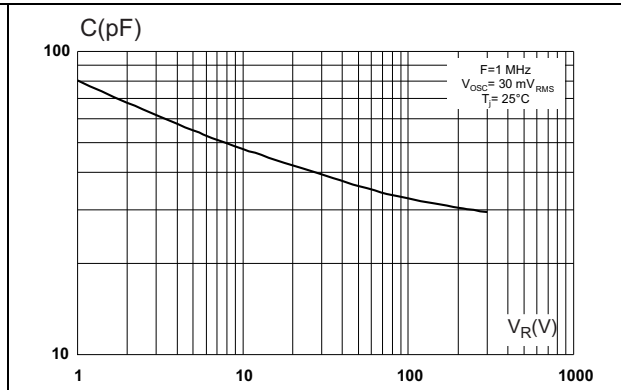

Figure 12. Junction capacitance versus reverse voltage applied (typical values, per diode)



## 2 Package information

- Epoxy meets UL94, V0
- Cooling method: by conduction (C)
- Recommended torque: TO-247 0.5 to 1.0 N·m

In order to meet environmental requirements, ST offers these devices in different grades of ECOPACK® packages, depending on their level of environmental compliance. ECOPACK® specifications, grade definitions and product status are available at: [www.st.com](http://www.st.com). ECOPACK® is an ST trademark.

Figure 13. TO-247 dimension definitions

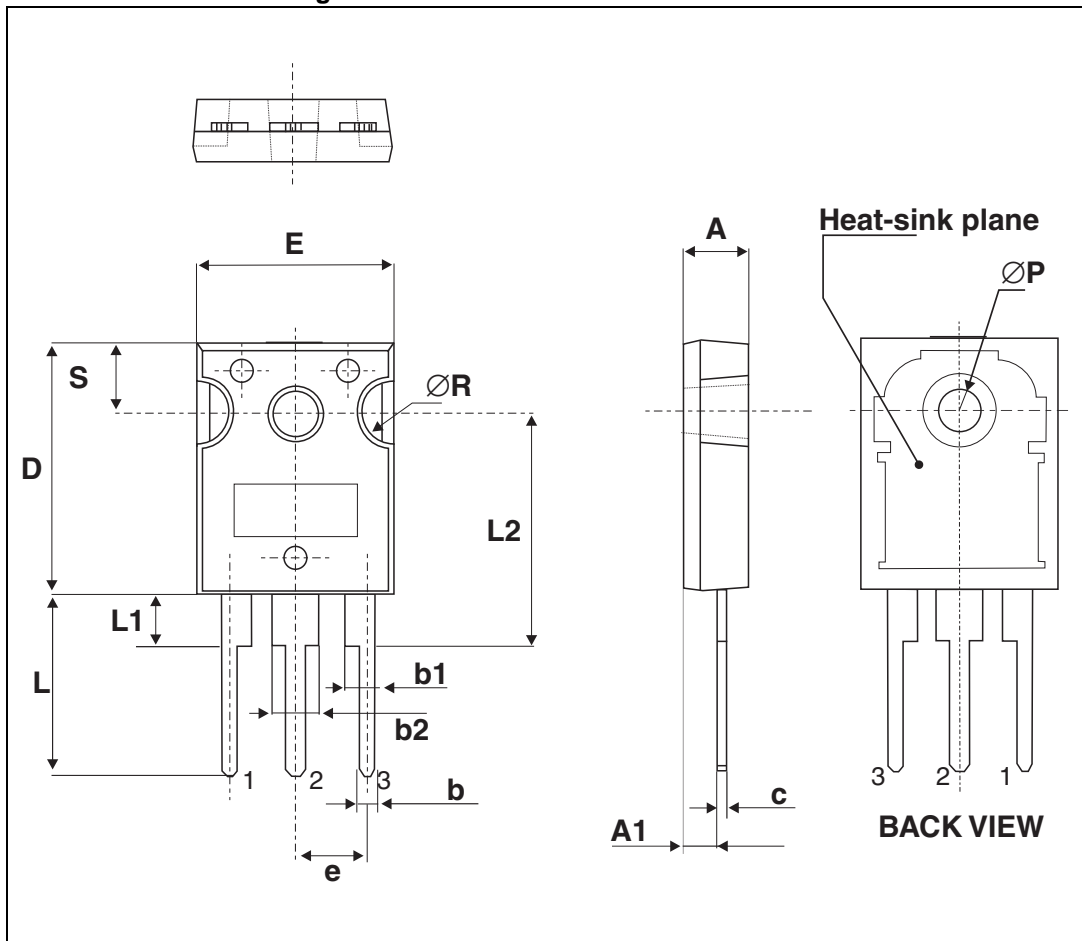

Table 6. TO-247 dimension values

Ref.	Dimensions					
	Millimeters			Inches		
	Min.	Typ.	Max.	Min.	Typ	Max.
A	4.85		5.15	0.191		0.203
A1	2.20		2.60	0.086		0.102
b	1.00		1.40	0.039		0.055
b1	2.00		2.40	0.078		0.094
b2	3.00		3.40	0.118		0.133
c	0.40		0.80	0.015		0.031
D <sup>(1)</sup>	19.85		20.15	0.781		0.793
E	15.45		15.75	0.608		0.620
e	5.30	5.45	5.60	0.209	0.215	0.220
L	14.20		14.80	0.559		0.582
L1	3.70		4.30	0.145		0.169
L2	18.50 typ.			0.728 typ.		
∅P <sup>(2)</sup>	3.55		3.65	0.139		0.143
∅R	4.50		5.50	0.177		0.217
S	5.30	5.50	5.70	0.209	0.216	0.224

1. Dimension D plus gate protrusion does not exceed 20.5 mm.
2. Resin thickness around the mounting hole is not less than 0.9 mm.

### 3 Ordering information

**Table 7. Ordering information**

Order code	Marking	Package	Weight	Base qty	Delivery mode
STTH60SW03CW	STTH60SW03CW	TO-247	4.46	50	Tube

### 4 Revision history

**Table 8. Document revision history**

Date	Revision	Changes
13-Jan-2015	1	First release.



**IMPORTANT NOTICE – PLEASE READ CAREFULLY**

STMicroelectronics NV and its subsidiaries (“ST”) reserve the right to make changes, corrections, enhancements, modifications, and improvements to ST products and/or to this document at any time without notice. Purchasers should obtain the latest relevant information on ST products before placing orders. ST products are sold pursuant to ST’s terms and conditions of sale in place at the time of order acknowledgement.

Purchasers are solely responsible for the choice, selection, and use of ST products and ST assumes no liability for application assistance or the design of Purchasers’ products.

No license, express or implied, to any intellectual property right is granted by ST herein.

Resale of ST products with provisions different from the information set forth herein shall void any warranty granted by ST for such product.

ST and the ST logo are trademarks of ST. All other product or service names are the property of their respective owners.

Information in this document supersedes and replaces information previously supplied in any prior versions of this document.

© 2015 STMicroelectronics – All rights reserved