

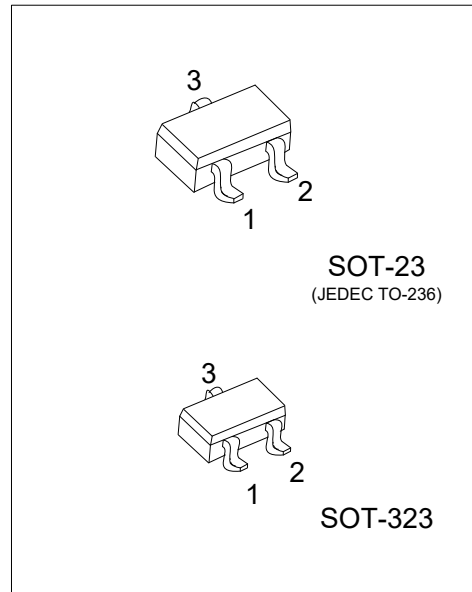

## MMBT945

## NPN SILICON TRANSISTOR

AUDIO FREQUENCY  
AMPLIFIER HIGH FREQUENCY  
OSC NPN TRANSISTOR



### DESCRIPTION

The UTC **MMBT945** is an audio frequency amplifier high frequency OSC NPN transistor.

### FEATURES

- \* Collector-Emitter Voltage:  $BV_{CEO}=60V$
- \* Collector Current up to 150mA
- \* High  $h_{FE}$  Linearity
- \* Complimentary to UTC MMBT733

### ORDERING INFORMATION

Ordering Number		Package	Pin Assignment			Packing
Lead Free	Halogen Free		1	2	3	
MMBT945L-x-AE3-R	MMBT945G-x-AE3-R	SOT-23	B	E	C	Tape Reel
MMBT945L-x-AL3-R	MMBT945G-x-AL3-R	SOT-323	B	E	C	Tape Reel

Note: Pin Assignment: B: Base E: Emitter C: Collector

<p>MMBT945G-x-AE3-R</p> <p>(1)Packing Type (2)Package Type (3)Rank (4)Green Package</p>	<p>(1) R: Tape Reel (2) AE3: SOT-23, AL3: SOT-323 (3) x: refer to Classification of <math>h_{FE}</math> (4) G: Halogen Free and Lead Free, L: Lead Free</p>
---	---

### MARKING

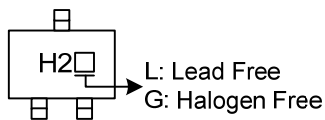

# MMBT945

## NPN SILICON TRANSISTOR

### ■ ABSOLUTE MAXIMUM RATINGS ( $T_A=25^\circ\text{C}$ , unless otherwise specified )

PARAMETER	SYMBOL	RATING	UNIT
Collector-Base Voltage	$V_{CBO}$	60	V
Collector-Emitter Voltage	$V_{CEO}$	50	V
Emitter-Base Voltage	$V_{EBO}$	5	V
Collector Current	$I_C$	150	mA
Base Current	$I_B$	50	mA
Collector Dissipation( $T_a=25^\circ\text{C}$ )	$P_C$	200	mW
Junction Temperature	$T_J$	+125	$^\circ\text{C}$
Storage Temperature	$T_{STG}$	-55 ~ +125	$^\circ\text{C}$

Note: Absolute maximum ratings are those values beyond which the device could be permanently damaged. Absolute maximum ratings are stress ratings only and functional device operation is not implied.

### ■ ELECTRICAL CHARACTERISTICS ( $T_A=25^\circ\text{C}$ , unless otherwise specified)

PARAMETER	SYMBOL	TEST CONDITIONS	MIN	TYP	MAX	UNIT
Collector-Base Breakdown Voltage	$BV_{CBO}$	$I_C=100\mu\text{A}, I_E=0$	60			V
Collector-Emitter Breakdown Voltage	$BV_{CEO}$	$I_C=10\text{mA}, I_B=0$	50			V
Collector Cut-Off Current	$I_{CBO}$	$V_{CB}=40\text{V}, I_E=0$			100	nA
Emitter Cut-Off Current	$I_{EBO}$	$V_{EB}=3\text{V}, I_C=0$			100	nA
DC Current Gain	$h_{FE}$	$V_{CE}=6\text{V}, I_C=1\text{mA}$	90		600	
Collector-Emitter Saturation Voltage	$V_{CE(SAT)}$	$I_C=100\text{mA}, I_B=10\text{mA}$		0.1	0.3	V
Current Gain Bandwidth Product	$f_T$	$V_{CE}=10\text{V}, I_C=50\text{mA}$	100	190		MHz
Output Capacitance	$C_{OB}$	$V_{CB}=10\text{V}, I_E=0, f=1\text{MHz}$		2.0	3.0	pF
Noise Figure	NF	$I_C=-0.1\text{mA}, V_{CE}=6\text{V}$ $R_G=10\text{k}\Omega, f=100\text{Hz}$		4.0	6.0	dB

### ■ CLASSIFICATION OF $h_{FE}$

RANK	R	Q	P	K
RANGE	90-180	135-270	200-400	300-600

## ■ TYPICAL CHARACTERISTICS

Static Characteristics

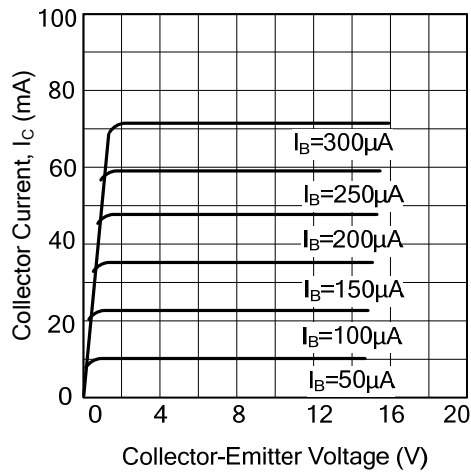

DC Current Gain

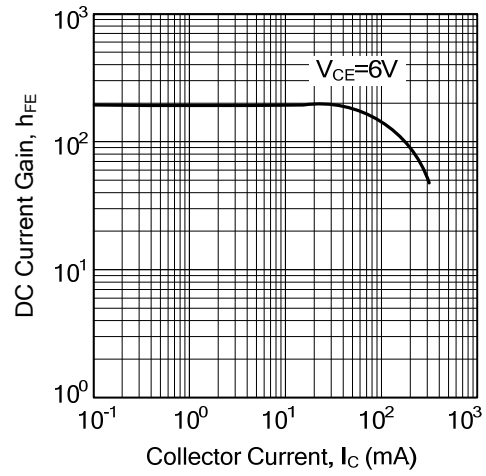

Base-Emitter on Voltage

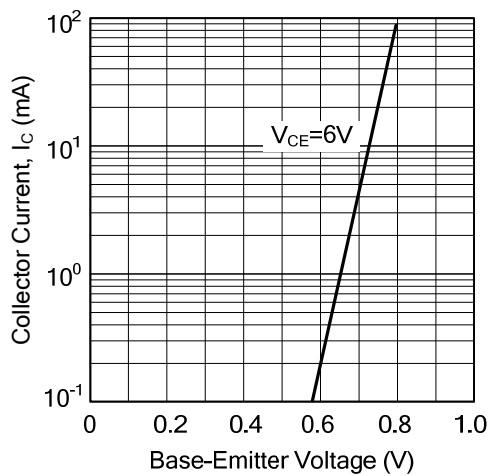

Saturation Voltage

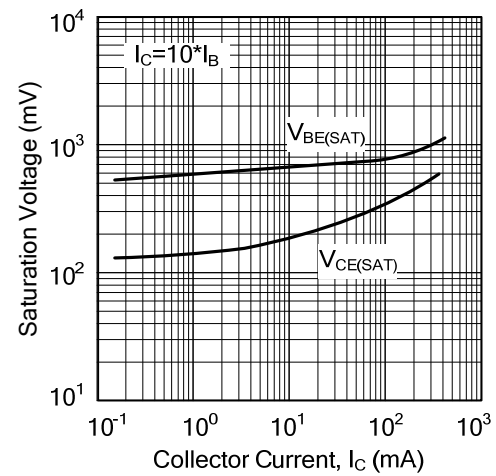

Current Gain-Bandwidth Product

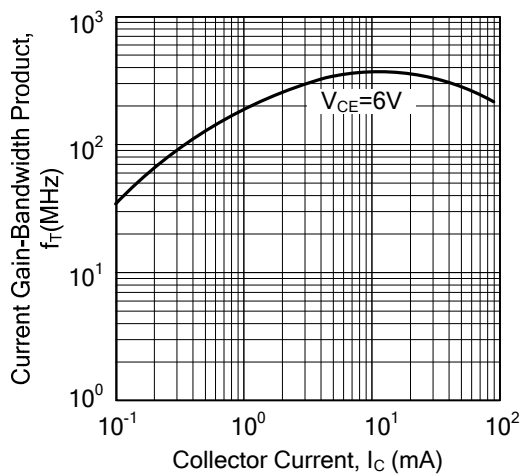

Collector Output Capacitance

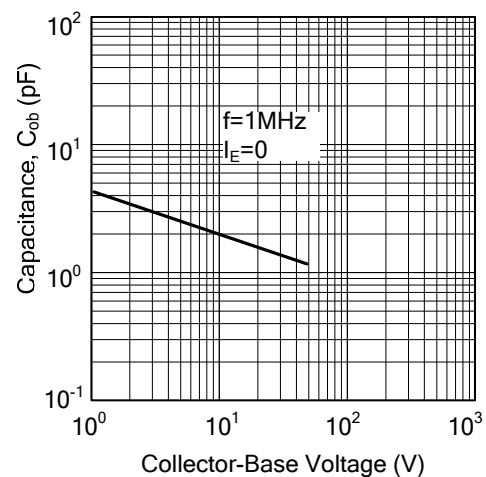

UTC assumes no responsibility for equipment failures that result from using products at values that exceed, even momentarily, rated values (such as maximum ratings, operating condition ranges, or other parameters) listed in products specifications of any and all UTC products described or contained herein. UTC products are not designed for use in life support appliances, devices or systems where malfunction of these products can be reasonably expected to result in personal injury. Reproduction in whole or in part is prohibited without the prior written consent of the copyright owner. UTC reserves the right to make changes to information published in this document, including without limitation specifications and product descriptions, at any time and without notice. This document supersedes and replaces all information supplied prior to the publication hereof.