

- Free-Air Operating Temperature
–40°C to 150°C
- Output Swing Includes Both Supply Rails
- Low Noise . . . 9 nV/√Hz Typ at f = 1 kHz
- Low Input Bias Current . . . 1 pA Typ
- Common-Mode Input Voltage Range
Includes Negative Rail
- High Unity-Gain Bandwidth . . . 2.2 MHz Typ
- High Slew Rate . . . 3.6 V/μs Typ
- Low Input Offset Voltage
300 μV Typ at T_A = 25°C
- Macromodel Included

description

The TLC2872Z is a dual rail-to-rail output operational amplifier manufactured using Texas Instruments Advanced LinCMOS™ process. These devices offer comparable ac performance while having better noise, input offset voltage and power dissipation than existing CMOS operational amplifiers. In addition, the common-mode input voltage range is wider than typical standard CMOS type amplifiers. To take advantage of this improvement in performance, making this device available for a wider range of applications, V_{ICR} is specified with a larger maximum input offset voltage test limit of ±5 mV. The Advanced LinCMOS™ process uses a silicon-gate technology to obtain input offset voltage stability with temperature and time that far exceeds that obtainable using metal-gate technology. Also, this technology makes possible input impedance levels that meet or exceed levels offered by top-gate JFET and expensive dielectric-isolated devices.

The TLC2872Z, manufactured using Texas Instruments high-temperature process flow, allows extended temperature operation up to 150°C in a plastic package. This adds extra reliability at the extended temperature and reduces the need for expensive hermetically sealed ceramic packages.

The TLC2872Z, which exhibits high input impedance and low noise, is excellent for small signal conditioning of high impedance sources, such as piezoelectric transducers. In addition, the rail-to-rail output feature with single or split supplies makes this device a great choice for inputs to ADCs in either the unipolar or bipolar mode of operation. This feature, combined with its temperature performance, makes the TLC2872Z ideal for sonobuoys, pressure sensors, temperature controls, active VR sensors, accelerometers, and many other applications.

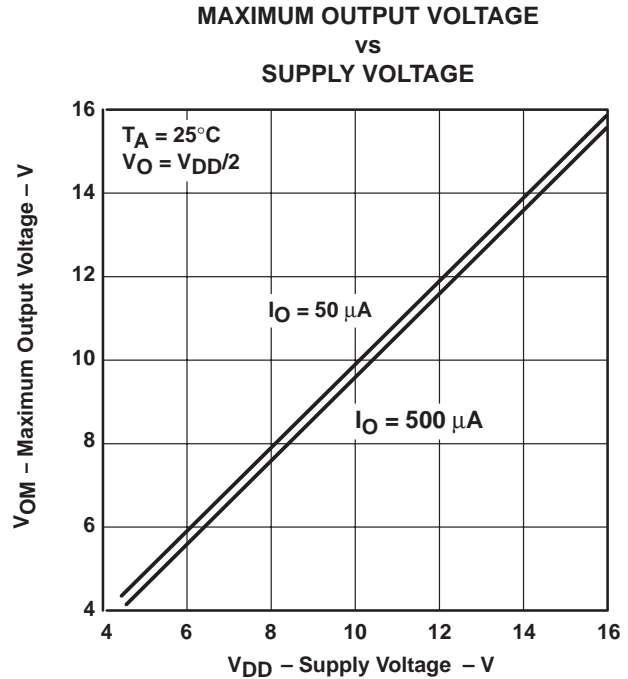
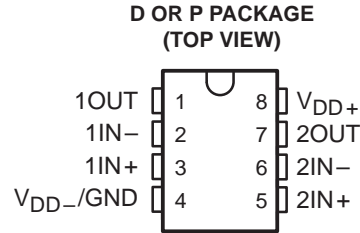

AVAILABLE OPTIONS

T _A	V _{IOmax} AT 25°C	PACKAGED DEVICES		CHIP FORM (Y)
		SMALL OUTLINE (D)	PLASTIC DIP (P)	
–40°C to 150°C	2.5 mV	TLC2872ZD	TLC2872ZP	TLC2872Y

The D packages are available taped and reeled. Add R suffix to device type (e.g., TLC2872DR).

Advanced LinCMOS is a trademark of Texas Instruments Incorporated.

PRODUCTION DATA information is current as of publication date. Products conform to specifications per the terms of Texas Instruments standard warranty. Production processing does not necessarily include testing of all parameters.



TLC2872Z, TLC2872Y
Advanced LinCMOS™ RAIL-TO-RAIL
DUAL OPERATIONAL AMPLIFIERS
 SLOS117 – OCTOBER 1992

description (continued)

The inputs and outputs of this device are designed to withstand 100-mA surge current without sustaining latch-up. In addition, internal ESD-protection circuits prevent functional failures up to 2000 V. The device is characterized for operation over the extended (Z) temperature range of -40°C to 150°C .

TLC2872Y chip information

This chip, when properly assembled, displays characteristics similar to TLC2872Z. Thermal compression or ultrasonic bonding may be used on the doped-aluminum bonding pads. Chips may be mounted with conductive epoxy or a gold-silicon preform.

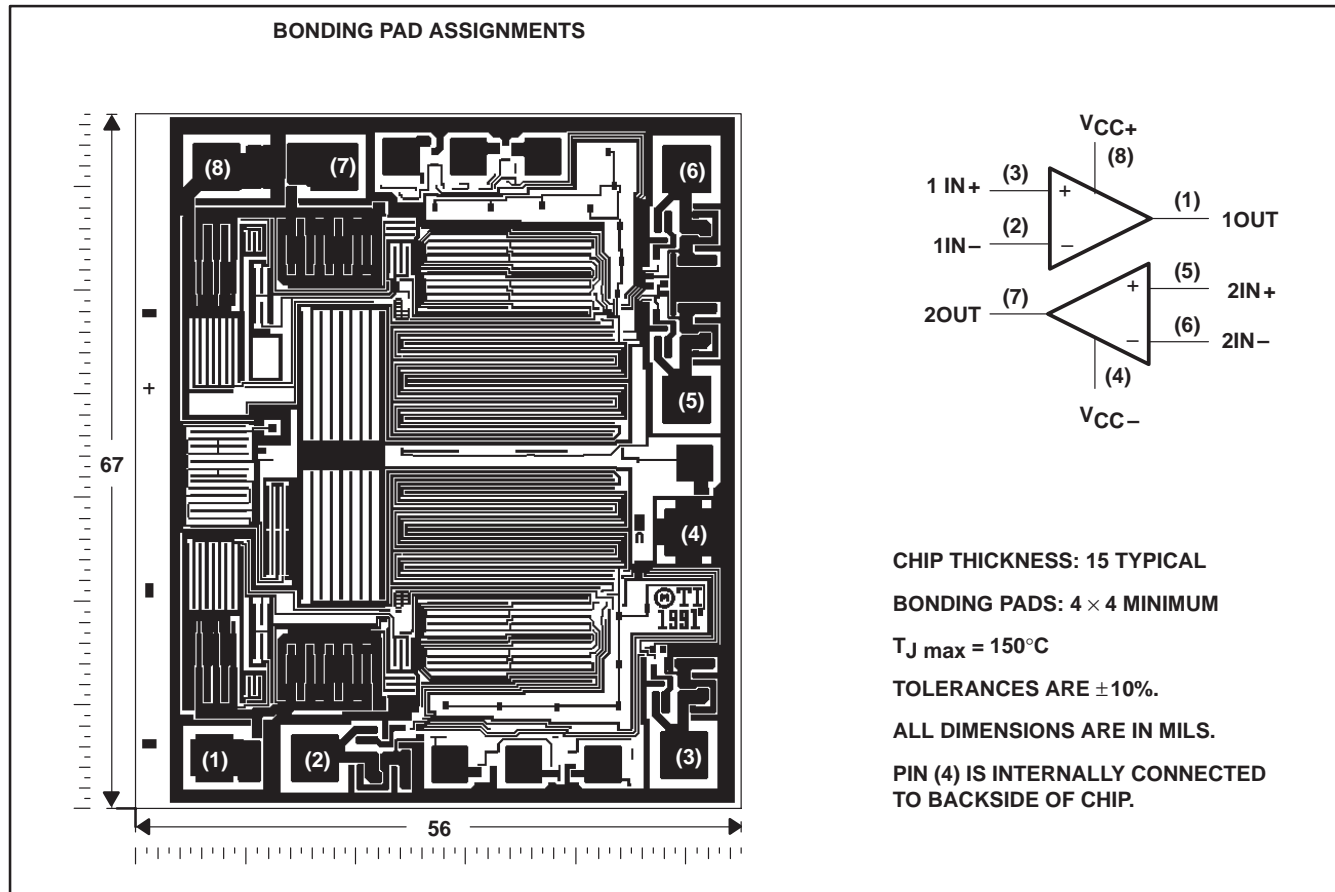

equivalent schematic (each amplifier)

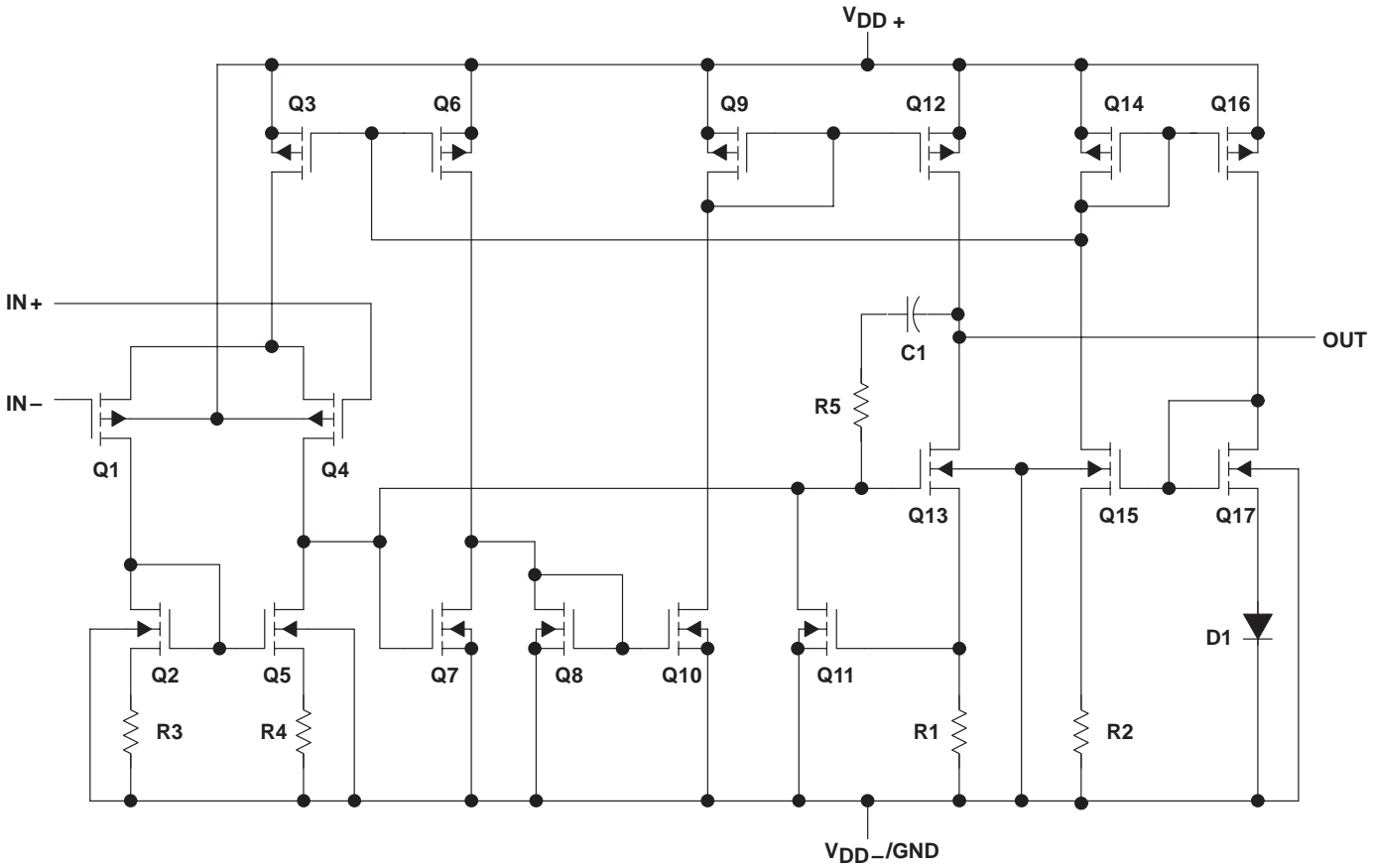

COMPONENT	COUNT†
Transistors	38
Diodes	9
Resistors	26
Capacitors	3

† Includes both amplifiers and all ESD, bias, and trim circuitry.

TLC2872Z, TLC2872Y
Advanced LinCMOS™ RAIL-TO-RAIL
DUAL OPERATIONAL AMPLIFIERS
 SLOS117 – OCTOBER 1992

absolute maximum ratings over operating free-air temperature range (unless otherwise noted)†

Supply voltage, V_{DD+}	8 V
Supply voltage, V_{DD-}	-8 V
Differential input voltage, V_{ID} (see Note 1)	± 16 V
Input voltage range, V_I (any input, see Note 2)	± 8 V
Input current, I_I (each input)	± 5 mA
Output current, I_O	± 50 mA
Total current into V_{DD+}	± 50 mA
Total current out of V_{DD-}	± 50 mA
Duration of short-circuit current at (or below) 25°C (see Note 3)	unlimited
Continuous total dissipation	See Dissipation Rating Table
Operating free-air temperature range, T_A	-40°C to 150°C
Storage temperature range	-65°C to 165°C
Lead temperature 1,6 mm (1/16 inch) from case for 10 seconds	260°C

† Stresses beyond those listed under “absolute maximum ratings” may cause permanent damage to the device. These are stress ratings only, and functional operation of the device at these or any other conditions beyond those indicated under “recommended operating conditions” is not implied. Exposure to absolute-maximum-rated conditions for extended periods may affect device reliability.

- NOTES: 1. Differential voltages are at $IN+$ with respect to $IN-$. Excessive current will flow if input is brought below $V_{DD-} - 0.3$ V.
 2. All voltage values, except differential voltages, are with respect to the midpoint between V_{DD+} and V_{DD-} .
 3. The output may be shorted to either supply. Temperature and/or supply voltages must be limited to ensure that the maximum dissipation rating is not exceeded.

DISSIPATION RATING TABLE

PACKAGE	$T_A \leq 25^\circ\text{C}$ POWER RATING	DERATING FACTOR ABOVE $T_A = 25^\circ\text{C}$	$T_A = 70^\circ\text{C}$ POWER RATING	$T_A = 105^\circ\text{C}$ POWER RATING	$T_A = 125^\circ\text{C}$ POWER RATING	$T_A = 150^\circ\text{C}$ POWER RATING
D	812 mW	5.8 mW/°C	551 mW	348 mW	232 mW	87 mW
P	1120 mW	8 mW/°C	760 mW	480 mW	320 mW	120 mW

recommended operating conditions

	MIN	MAX	UNIT
Supply voltage, $V_{DD\pm}$	± 2.2	± 8	V
Input voltage range, V_I	V_{DD-}	$V_{DD+} - 1.5$	V
Common-mode input voltage, V_{IC}	V_{DD-}	$V_{DD+} - 1.5$	V
Operating free-air temperature, T_A	-40	150	°C



electrical characteristics at specified free-air temperature, $V_{DD} = 5\text{ V}$ (unless otherwise noted)

PARAMETER	TEST CONDITIONS	T_A^\dagger	TLC2872Z			UNIT
			MIN	TYP	MAX	
V_{IO} Input offset voltage	$V_{DD} = \pm 2.5\text{ V}$, $V_O = 0$, $V_{IC} = 0$, $R_S = 50\ \Omega$	25°C		300	2500	μV
		Full range			3000	
α_{VIO} Temperature coefficient of input offset voltage		25°C to 150°C		2		$\mu\text{V}/^\circ\text{C}$
Input offset voltage long-term drift (see Note 4)		25°C		0.002		$\mu\text{V}/\text{mo}$
I_{IO} Input offset current		25°C		0.0005		nA
		Full range			3	
I_{IB} Input bias current		25°C		0.001		nA
		Full range			5	
V_{ICR} Common-mode input voltage range	$R_S = 50\ \Omega$, $ V_{IO} \leq 5\text{ mV}$	25°C	0 to 4	-0.3 to 4.2	V	
		Full range	0 to 3.5			
V_{OH} High-level output voltage	$I_{OH} = -20\ \mu\text{A}$ $I_{OH} = -200\ \mu\text{A}$ $I_{OH} = -1\text{ mA}$	25°C	4.95	4.99	V	
		25°C	4.85	4.93		
		Full range	4.75			
		25°C	4.25	4.65		
V_{OL} Low-level output voltage	$V_{IC} = 2.5\text{ V}$, $I_{OL} = 50\ \mu\text{A}$ $I_{OL} = 500\ \mu\text{A}$ $I_{OL} = 5\text{ mA}$	25°C	0.01	0.02	V	
		25°C	0.09	0.15		
		Full range		0.2		
		25°C	0.9	1.5		
A_{VD} Large-signal differential voltage amplification	$V_{IC} = 2.5\text{ V}$, $V_O = 1\text{ V to }4\text{ V}$	25°C	$R_L = 10\ \text{k}\Omega^\ddagger$	15	35	V/mV
			Full range	10		
		25°C	$R_L = 1\ \text{M}\Omega^\ddagger$		175	
r_{id} Differential input resistance		25°C		10^{12}	Ω	
r_i Common-mode input resistance		25°C		10^{12}	Ω	
c_i Common-mode input capacitance	$f = 10\ \text{kHz}$, P package	25°C		8	pF	
z_o Closed-loop output impedance	$f = 1\ \text{MHz}$, $A_V = 10$	25°C		140	Ω	
CMRR Common-mode rejection ratio	$V_{IC} = 0\text{ to }2.7\text{ V}$, $R_S = 50\ \Omega$, $V_O = 2.5\text{ V}$	25°C	70	75	dB	
		Full range	70			
k_{SVR} Supply voltage rejection ratio ($\Delta V_{DD}/\Delta V_{IO}$)	$V_{DD} = 4.4\text{ V to }16\text{ V}$, No load $V_{IC} = V_{DD}/2$	25°C	80	95	dB	
		Full range	80			
I_{DD} Supply current	$V_O = 2.5\text{ V}$, No load	25°C	2.2	3	mA	
		Full range		3		

† Full range is -40°C to 150°C .

‡ Referenced to 2.5 V

NOTE 4: Typical values are based on the input offset voltage shift observed through 168 hours of operating life test at $T_A = 150^\circ\text{C}$ extrapolated to $T_A = 25^\circ\text{C}$ using the Arrhenius equation and assuming an activation energy of 0.96 eV.

TLC2872Z, TLC2872Y
Advanced LinCMOS™ RAIL-TO-RAIL
DUAL OPERATIONAL AMPLIFIERS

SLOS117 – OCTOBER 1992

operating characteristics at specified free-air temperature, $V_{DD} = 5\text{ V}$

PARAMETER	TEST CONDITIONS	T_A †	TLC2872Z			UNIT
			MIN	TYP	MAX	
SR Slew rate at unity gain	$V_O = 0.5\text{ V to }2.5\text{ V}, R_L = 10\text{ k}\Omega\ddagger, C_L = 100\text{ pF}\ddagger$	25°C	2.3	3.6		V/ μ s
		Full range	1.1			
V_n Equivalent input noise voltage	$f = 10\text{ Hz}$	25°C	50			nV/ $\sqrt{\text{Hz}}$
	$f = 1\text{ kHz}$	25°C	9			
$V_{N(PP)}$ Peak-to-peak equivalent input noise voltage	$f = 0.1\text{ to }1\text{ Hz}$	25°C	1			μ V
	$f = 0.1\text{ to }10\text{ Hz}$	25°C	1.4			
I_n Equivalent input noise current		25°C	0.6			fA/ $\sqrt{\text{Hz}}$
THD + N Total harmonic distortion plus noise	$V_O = 0.5\text{ V to }2.5\text{ V}, f = 20\text{ kHz}, R_L = 10\text{ k}\Omega\ddagger$	25°C	$A_V = 1$	0.0013%		
			$A_V = 10$	0.004%		
			$A_V = 100$	0.03%		
Gain-bandwidth product	$f = 10\text{ kHz}, C_L = 100\text{ pF}\ddagger$	$R_L = 10\text{ k}\Omega\ddagger, 25^\circ\text{C}$	2.18			MHz
BOM Maximum output-swing bandwidth	$V_{O(PP)} = 2\text{ V}, R_L = 10\text{ k}\Omega\ddagger,$	$A_V = 1, C_L = 100\text{ pF}\ddagger$	25°C	1		MHz
Settling time	$A_V = -1, \text{ Step} = 0.5\text{ V to }2.5\text{ V}, R_L = 10\text{ k}\Omega\ddagger, C_L = 100\text{ pF}\ddagger$	To 0.1%	25°C	1.5		μ s
		To 0.01%		2.6		
ϕ_m Phase margin at unity gain	$R_L = 10\text{ k}\Omega\ddagger, C_L = 100\text{ pF}\ddagger$	25°C	50°			
Gain margin		25°C	10			dB

† Full range is -40°C to 150°C .

‡ Referenced to 2.5 V



electrical characteristics, $V_{DD} = 5\text{ V}$, $T_A = 25^\circ\text{C}$ (unless otherwise noted)

PARAMETER		TEST CONDITIONS		TLC2872Y			UNIT
				MIN	TYP	MAX	
V_{IO}	Input offset voltage	$V_{IC} = 0,$ $R_S = 50\ \Omega$	$V_O = 0,$		300	2500	μV
	Input offset voltage long-term drift (see Note 4)				0.002		$\mu\text{V}/\text{mo}$
I_{IO}	Input offset current				0.0005		nA
I_{IB}	Input bias current				0.001		nA
V_{ICR}	Common-mode input voltage range	$R_S = 50\ \Omega,$	$ V_{IO} \leq 5\ \text{mV}$	0 to 4	-0.3 to 4.2		V
				0 to 3.5			
V_{OH}	High-level output voltage	$I_{OH} = -20\ \mu\text{A}$		4.95	4.99	V	
		$I_{OH} = -200\ \mu\text{A}$		4.85	4.93		
		$I_{OH} = -1\ \text{mA}$		4.25	4.65		
V_{OL}	Low-level output voltage	$V_{IC} = 2.5\ \text{V}, I_{OL} = 50\ \mu\text{A}$		0.01	0.02	V	
		$V_{IC} = 2.5\ \text{V}, I_{OL} = 500\ \mu\text{A}$		0.09	0.15		
		$V_{IC} = 2.5\ \text{V}, I_{OL} = 5\ \text{mA}$		0.9	1.5		
A_{VD}	Large-signal differential voltage amplification	$V_{IC} = 2.5\ \text{V},$ $V_O = 1\ \text{V to } 4\ \text{V}$	$R_L = 10\ \text{k}\Omega^\dagger$	15	35	V/mV	
			$R_L = 1\ \text{M}\Omega^\dagger$		175		
r_{id}	Differential input resistance			10^{12}		Ω	
r_i	Common-mode input resistance			10^{12}		Ω	
c_i	Common-mode input capacitance	$f = 10\ \text{kHz},$	P package		8	pF	
z_o	Closed-loop output impedance	$f = 1\ \text{MHz},$	$A_V = 10$		140	Ω	
CMRR	Common-mode rejection ratio	$V_{IC} = 0\ \text{to } 2.7\ \text{V},$ $R_S = 50\ \Omega$	$V_O = 2.5\ \text{V},$	70	75	dB	
k_{SVR}	Supply voltage rejection ratio ($\Delta V_{DD\pm} / \Delta V_{IO}$)	$V_{DD} = 4.4\ \text{V to } 16\ \text{V},$ No load	$V_{IC} = V_{DD}/2,$	80	95	dB	
I_{DD}	Supply current	$V_O = 2.5\ \text{V},$	No load	2.2	3	mA	

† Referenced to 2.5 V

TLC2872Z, TLC2872Y
Advanced LinCMOS™ RAIL-TO-RAIL
DUAL OPERATIONAL AMPLIFIERS

SLOS117 – OCTOBER 1992

operating characteristics, $V_{DD} = 5\text{ V}$, $T_A = 25^\circ\text{C}$

PARAMETER		TEST CONDITIONS		TLC2872Y			UNIT	
				MIN	TYP	MAX		
SR	Slew rate at unity gain	$V_O = 0.5\text{ V to }2.5\text{ V}$, $R_L = 10\text{ k}\Omega^\dagger$, $C_L = 100\text{ pF}^\dagger$		2.3	3.6		V/ μs	
V_n	Equivalent input noise voltage	$f = 10\text{ Hz}$		50			nV/ $\sqrt{\text{Hz}}$	
		$f = 1\text{ kHz}$		9				
$V_{N(PP)}$	Peak-to-peak equivalent input noise voltage	$f = 0.1\text{ to }1\text{ Hz}$		1			μV	
		$f = 0.1\text{ to }10\text{ Hz}$		1.4				
I_n	Equivalent input noise current			0.6			fA/ $\sqrt{\text{Hz}}$	
THD + N	Total harmonic distortion plus noise	$V_O = 0.5\text{ V to }2.5\text{ V}$, $f = 20\text{ kHz}$, $R_L = 10\text{ k}\Omega^\dagger$		$A_V = 1$				
				$A_V = 10$				0.0013%
				$A_V = 100$				0.004%
Gain-bandwidth product		$f = 10\text{ kHz}$, $C_L = 100\text{ pF}^\dagger$		$R_L = 10\text{ k}\Omega^\dagger$		2.18	MHz	
BOM	Maximum output-swing bandwidth	$V_{O(PP)} = 4.6\text{ V}$, $R_L = 10\text{ k}\Omega^\dagger$		$A_V = 1$, $C_L = 100\text{ pF}^\dagger$		1	MHz	
	Settling time	$A_V = -1$, Step = $0.5\text{ V to }2.5\text{ V}$, $R_L = 10\text{ k}\Omega^\dagger$, $C_L = 100\text{ pF}^\dagger$		To 0.1%		1.5	μs	
				To 0.01%		2.6		
ϕ_m	Phase margin at unity gain	$R_L = 10\text{ k}\Omega^\dagger$, $C_L = 100\text{ pF}^\dagger$				50°		
	Gain margin	$R_L = 10\text{ k}\Omega^\dagger$, $C_L = 100\text{ pF}^\dagger$				10	dB	

† Referenced to 2.5 V

TYPICAL CHARACTERISTICS

Table of Graphs

			FIGURE
V_{IO}	Input offset voltage	Distribution	1
αV_{IO}	Input offset voltage temperature coefficient	Distribution	2
I_{IB}/I_{IO}	Input bias and offset currents	vs Free-air temperature	3
V_I	Input voltage range	vs Free-air temperature	4
V_{OH}	High-level output voltage	vs Output current	5
V_{OL}	Low-level output voltage	vs Output current	6, 7
V_{OM}	Maximum output voltage	vs Frequency	8
I_{OS}	Short-circuit output current	vs Supply voltage	9
		vs Free-air temperature	10
A_{VD}	Large-signal differential voltage amplification	vs Load resistance	11
		vs Frequency	12
		vs Free-air temperature	13
I_{DD}	Supply current	vs Supply voltage	14
		vs Free-air temperature	15
SR	Slew rate	vs Load capacitance	16
		vs Free-air temperature	17
ϕ_m	Phase margin	vs Frequency	12
		vs Load capacitance	18
	Gain margin	vs Load capacitance	19

NOTE: All loads are referenced to 2.5 V.

TYPICAL CHARACTERISTICS

DISTRIBUTION OF TLC2872Z
 INPUT OFFSET VOLTAGE

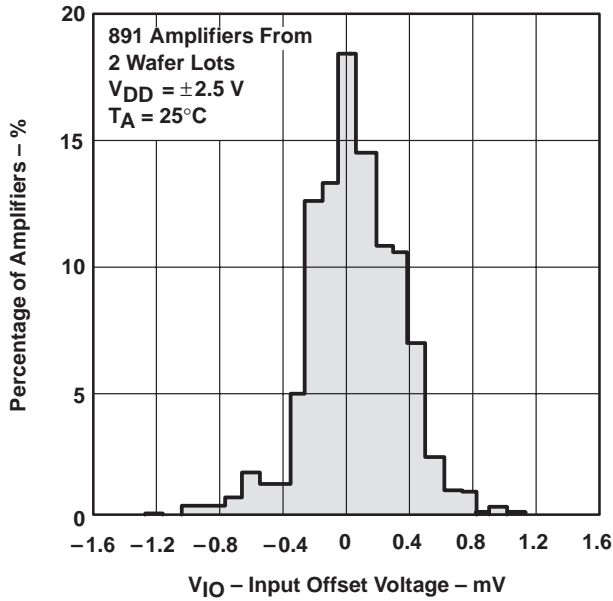

Figure 1

DISTRIBUTION OF TLC2872Z
 TEMPERATURE COEFFICIENT

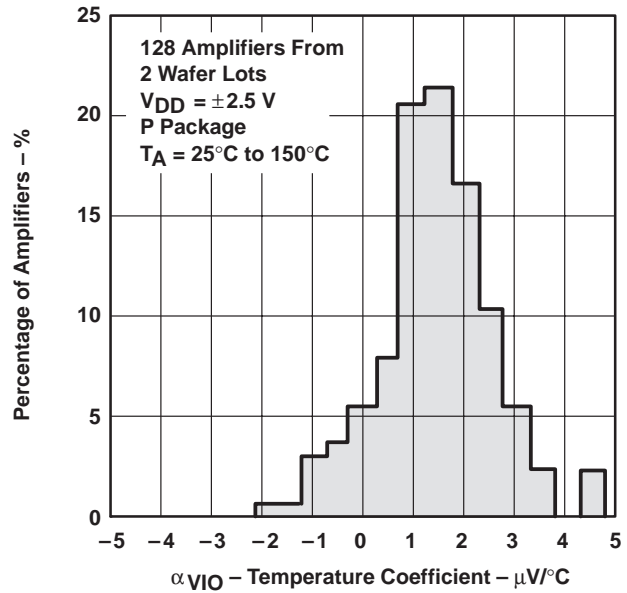

Figure 2

INPUT BIAS AND OFFSET CURRENTS
 vs
 FREE-AIR TEMPERATURE

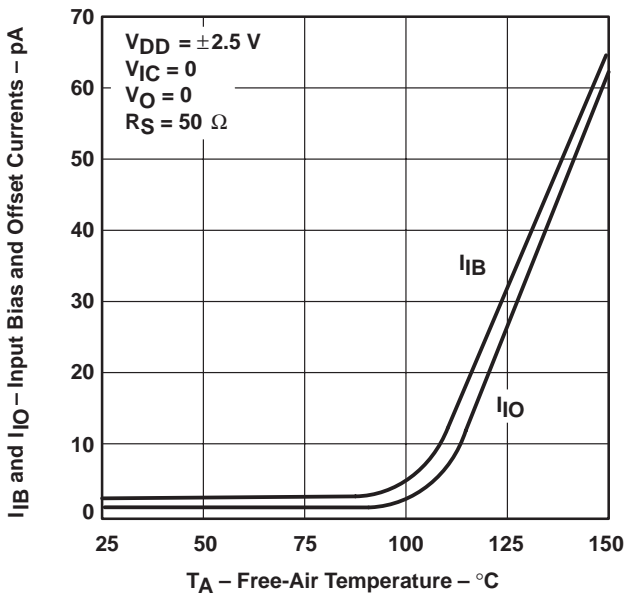

Figure 3

INPUT VOLTAGE RANGE
 vs
 FREE-AIR TEMPERATURE

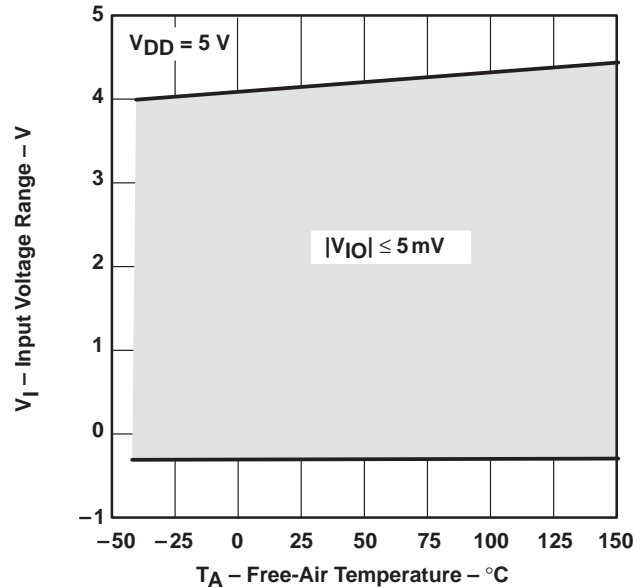

Figure 4

TYPICAL CHARACTERISTICS

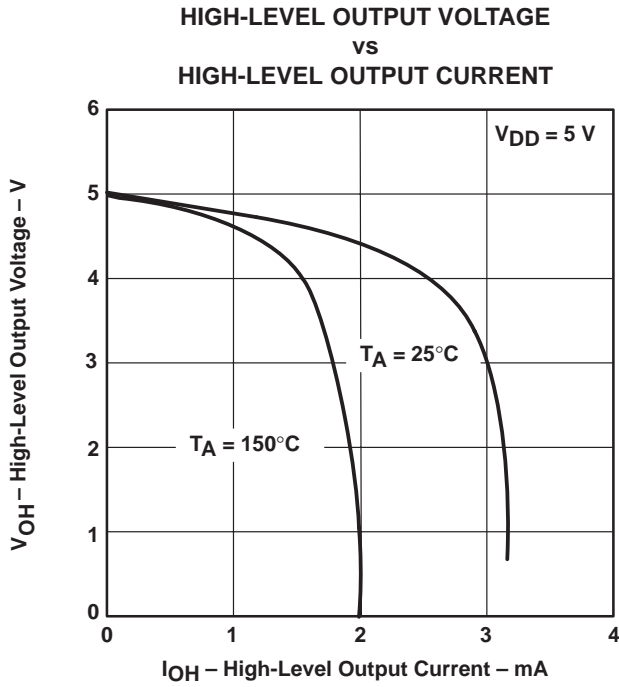

Figure 5

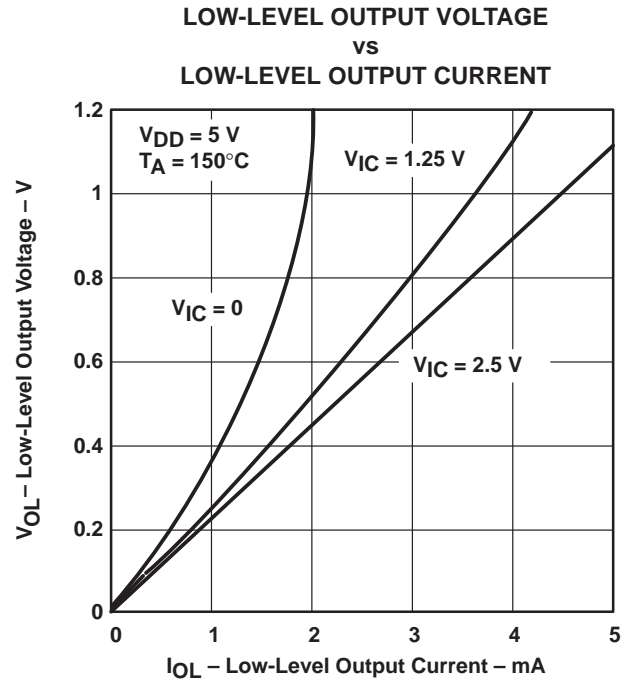

Figure 6

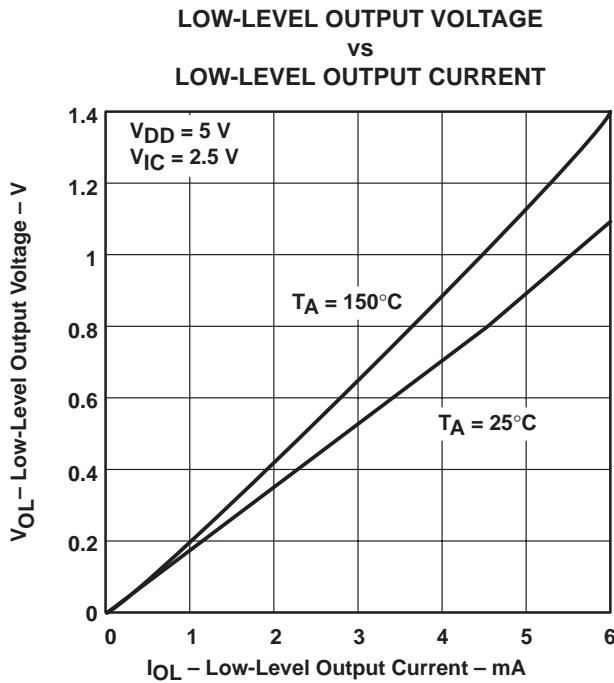

Figure 7

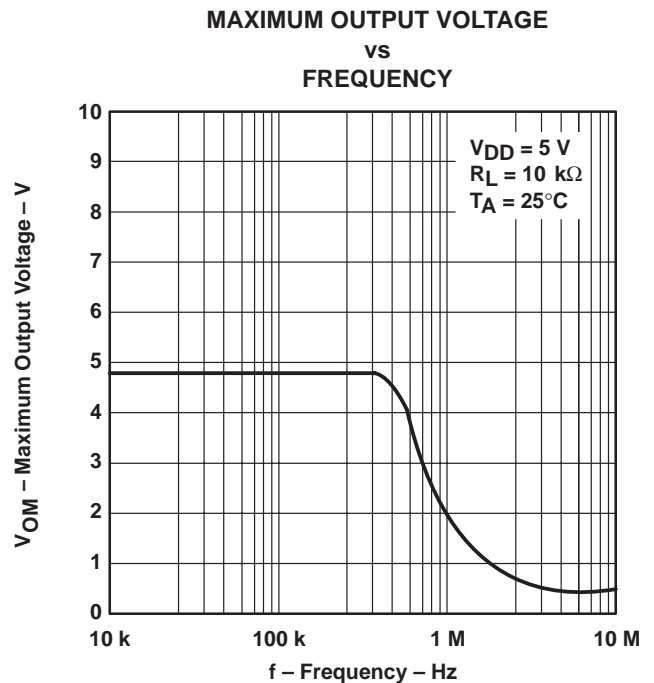

Figure 8

TYPICAL CHARACTERISTICS

SHORT-CIRCUIT OUTPUT CURRENT
 vs
 SUPPLY VOLTAGE

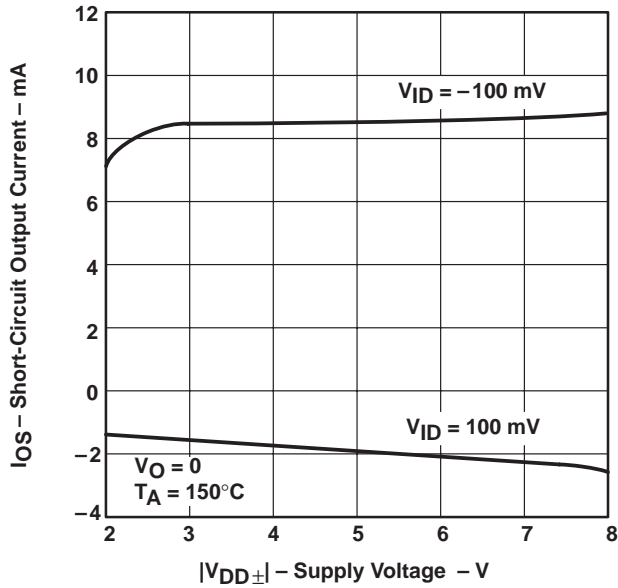

Figure 9

SHORT-CIRCUIT OUTPUT CURRENT
 vs
 FREE-AIR TEMPERATURE

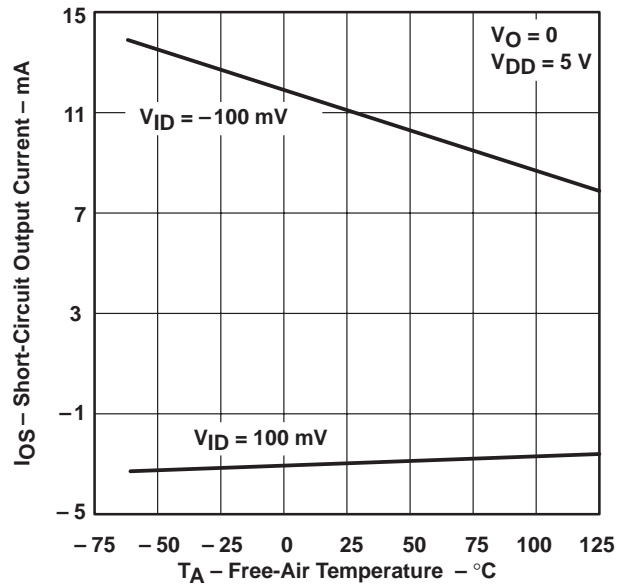

Figure 10

LARGE-SIGNAL DIFFERENTIAL
 VOLTAGE AMPLIFICATION
 vs
 LOAD RESISTANCE

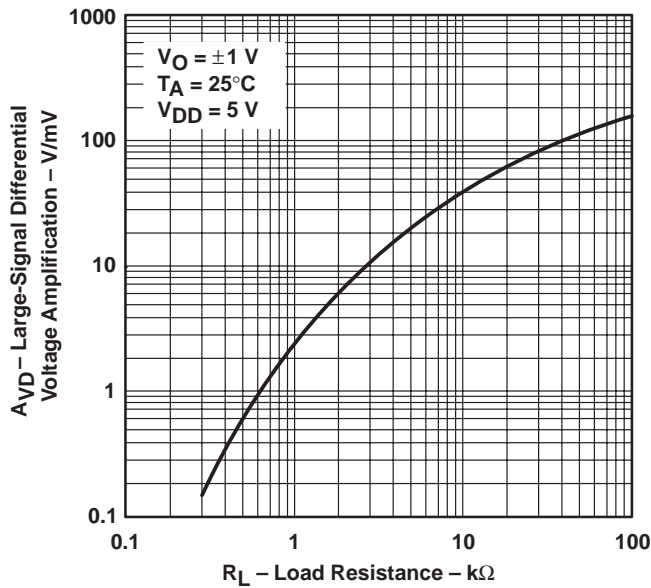

Figure 11

TYPICAL CHARACTERISTICS

LARGE-SIGNAL DIFFERENTIAL VOLTAGE
 AMPLIFICATION and PHASE MARGIN
 vs
 FREQUENCY

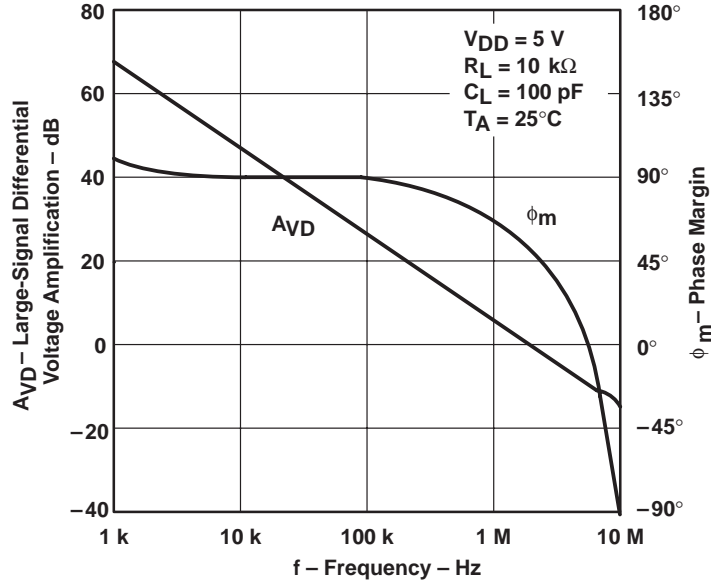

Figure 12

LARGE-SIGNAL DIFFERENTIAL
 VOLTAGE AMPLIFICATION
 vs
 FREE-AIR TEMPERATURE

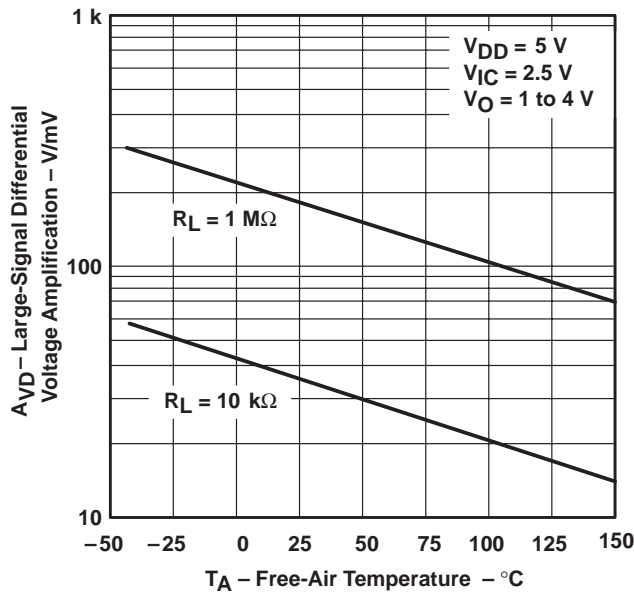

Figure 13

SUPPLY CURRENT
 vs
 SUPPLY VOLTAGE

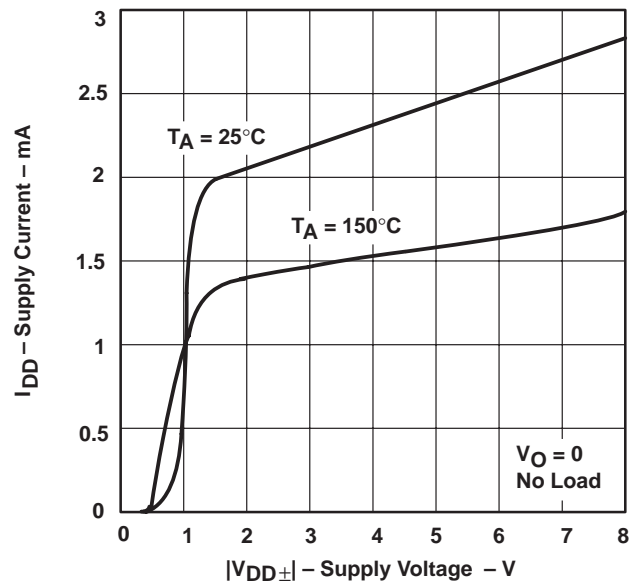
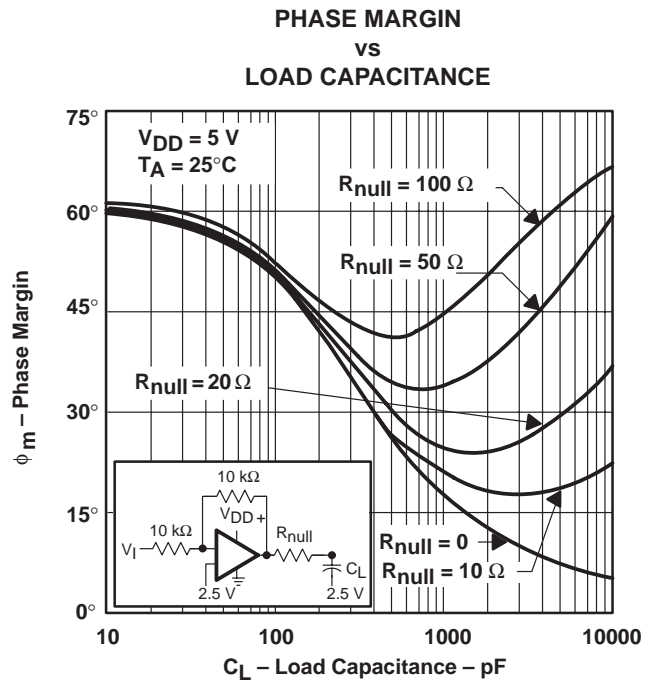
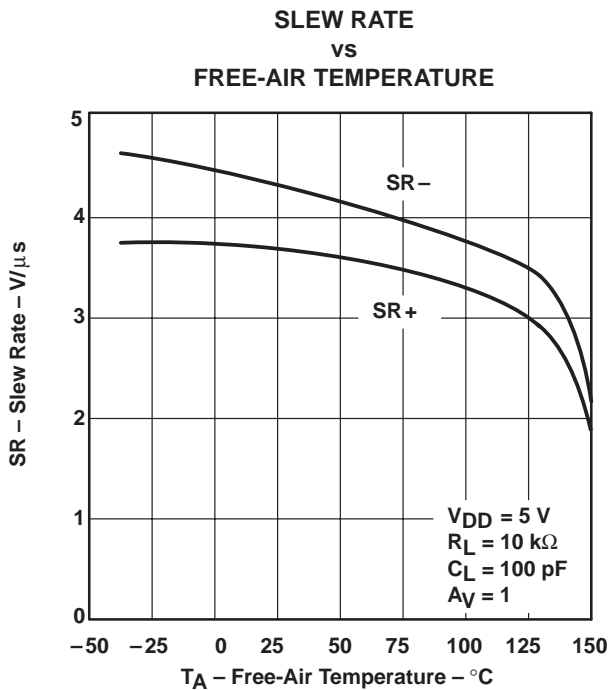
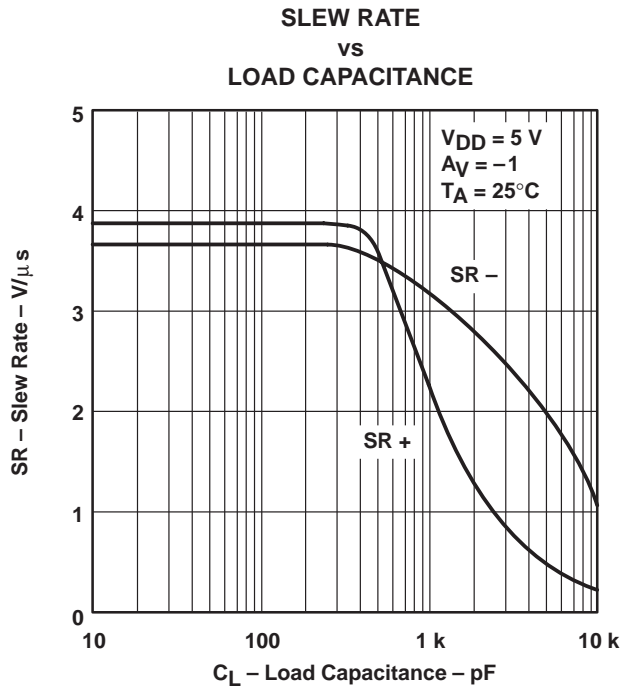
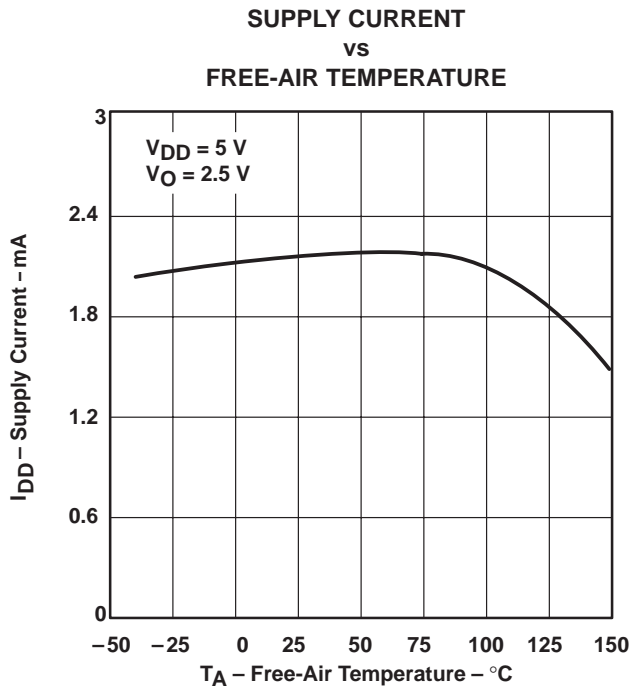

Figure 14

TYPICAL CHARACTERISTICS



TYPICAL CHARACTERISTICS†

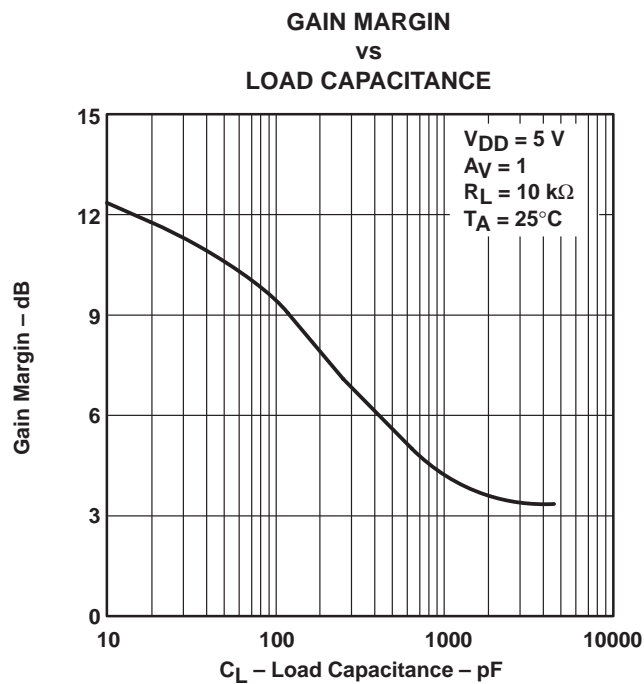

Figure 19

† Data at high and low temperatures are applicable only within the rated operating free-air temperature ranges of the various devices.

TLC2872Z, TLC2872Y

Advanced LinCMOS™ RAIL-TO-RAIL

DUAL OPERATIONAL AMPLIFIERS

SLOS117 – OCTOBER 1992

APPLICATION INFORMATION

macromodel information

Macromodel information provided was derived using *PSpice™ Parts™* model generation software. The Boyle macromodel (see Note 5) and subcircuit in Figure 20 were generated using the TLC2872Z typical electrical and operating characteristics at $T_A = 25^\circ\text{C}$. Using this information, output simulations of the following key parameters can be generated to a tolerance of 20% (in most cases):

- Maximum positive output voltage swing
- Maximum negative output voltage swing
- Slew rate
- Quiescent power dissipation
- Input bias current
- Open-loop voltage amplification
- Unity gain frequency
- Common-mode rejection ratio
- Phase margin
- DC output resistance
- AC output resistance
- Short-circuit output current limit

NOTE 5: G. R. Boyle, B. M. Cohn, D. O. Pederson, and J. E. Solomon, "Macromodeling of Integrated Circuit Operational Amplifiers," *IEEE Journal of Solid-State Circuits*, SC-9, 353 (1974).

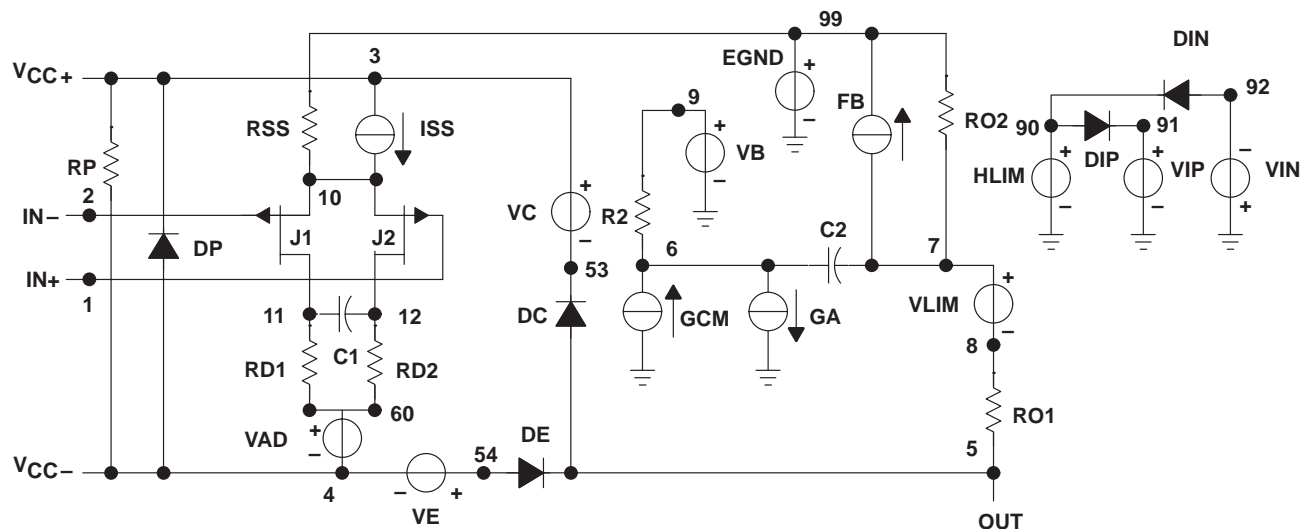

```
.SUBCKT TLC2872 1 2 3 4 5
C1 11 12 14E-12
C2 6 7 60.00E-12
DC 5 53 DX
DE 54 5 DX
DLP 90 91 DX
DLN 92 90 DX
DP 4 3 DX
EGND99 0 POLY (2) (3,0) (4,0) 0 .5 .5
FB 7 99 POLY (5) VB VC VE VLP VLN 0
+ 984.9E3 -1E6 1E6 1E6 -1E6
GA 6 0 11 12 377.0E-6
GCM 0 6 10 99 134E-9
ISS 3 10 DC 216.0E-6
HLIM 90 0 VLIM 1K
J1 11 2 10 JX
J2 12 1 10 JX
R2 6 9 100.OE3
RD1 60 11 2.653E3
RD2 60 12 2.653E3
R01 8 5 50
R02 7 99 50
RP 3 4 4.310E3
RSS 10 99 925.9E3
VAD 60 4 -.5
VB 9 0 DC 0
VC 3 53 DC .78
VE 54 4 DC .78
VLIM 7 8 DC 0
VLP 91 0 DC 1.9
VLN 0 92 DC 9.4
.MODEL DX D (IS=800.0E-18)
.MODEL JXPJF (IS=1.500E-12 BETA=1.316E3
+ VTO=-.270)
.ENDS
```

Figure 20. Boyle Macromodel and Subcircuit

PSpice and *Parts* are trademarks of MicroSim Corporation.

Macromodels, simulation models, or other models provided by TI, directly or indirectly, are not warranted by TI as fully representing all of the specification and operating characteristics of the semiconductor product to which the model relates.



POST OFFICE BOX 655303 • DALLAS, TEXAS 75265

IMPORTANT NOTICE

Texas Instruments and its subsidiaries (TI) reserve the right to make changes to their products or to discontinue any product or service without notice, and advise customers to obtain the latest version of relevant information to verify, before placing orders, that information being relied on is current and complete. All products are sold subject to the terms and conditions of sale supplied at the time of order acknowledgement, including those pertaining to warranty, patent infringement, and limitation of liability.

TI warrants performance of its semiconductor products to the specifications applicable at the time of sale in accordance with TI's standard warranty. Testing and other quality control techniques are utilized to the extent TI deems necessary to support this warranty. Specific testing of all parameters of each device is not necessarily performed, except those mandated by government requirements.

CERTAIN APPLICATIONS USING SEMICONDUCTOR PRODUCTS MAY INVOLVE POTENTIAL RISKS OF DEATH, PERSONAL INJURY, OR SEVERE PROPERTY OR ENVIRONMENTAL DAMAGE ("CRITICAL APPLICATIONS"). TI SEMICONDUCTOR PRODUCTS ARE NOT DESIGNED, AUTHORIZED, OR WARRANTED TO BE SUITABLE FOR USE IN LIFE-SUPPORT DEVICES OR SYSTEMS OR OTHER CRITICAL APPLICATIONS. INCLUSION OF TI PRODUCTS IN SUCH APPLICATIONS IS UNDERSTOOD TO BE FULLY AT THE CUSTOMER'S RISK.

In order to minimize risks associated with the customer's applications, adequate design and operating safeguards must be provided by the customer to minimize inherent or procedural hazards.

TI assumes no liability for applications assistance or customer product design. TI does not warrant or represent that any license, either express or implied, is granted under any patent right, copyright, mask work right, or other intellectual property right of TI covering or relating to any combination, machine, or process in which such semiconductor products or services might be or are used. TI's publication of information regarding any third party's products or services does not constitute TI's approval, warranty or endorsement thereof.