

# ON Semiconductor

## Is Now

# onsemi™

To learn more about onsemi™, please visit our website at  
[www.onsemi.com](http://www.onsemi.com)

---

**onsemi** and **onsemi** and other names, marks, and brands are registered and/or common law trademarks of Semiconductor Components Industries, LLC dba "**onsemi**" or its affiliates and/or subsidiaries in the United States and/or other countries. **onsemi** owns the rights to a number of patents, trademarks, copyrights, trade secrets, and other intellectual property. A listing of **onsemi** product/patent coverage may be accessed at [www.onsemi.com/site/pdf/Patent-Marking.pdf](http://www.onsemi.com/site/pdf/Patent-Marking.pdf). **onsemi** reserves the right to make changes at any time to any products or information herein, without notice. The information herein is provided "as-is" and **onsemi** makes no warranty, representation or guarantee regarding the accuracy of the information, product features, availability, functionality, or suitability of its products for any particular purpose, nor does **onsemi** assume any liability arising out of the application or use of any product or circuit, and specifically disclaims any and all liability, including without limitation special, consequential or incidental damages. Buyer is responsible for its products and applications using **onsemi** products, including compliance with all laws, regulations and safety requirements or standards, regardless of any support or applications information provided by **onsemi**. "Typical" parameters which may be provided in **onsemi** data sheets and/or specifications can and do vary in different applications and actual performance may vary over time. All operating parameters, including "Typicals" must be validated for each customer application by customer's technical experts. **onsemi** does not convey any license under any of its intellectual property rights nor the rights of others. **onsemi** products are not designed, intended, or authorized for use as a critical component in life support systems or any FDA Class 3 medical devices or medical devices with a same or similar classification in a foreign jurisdiction or any devices intended for implantation in the human body. Should Buyer purchase or use **onsemi** products for any such unintended or unauthorized application, Buyer shall indemnify and hold **onsemi** and its officers, employees, subsidiaries, affiliates, and distributors harmless against all claims, costs, damages, and expenses, and reasonable attorney fees arising out of, directly or indirectly, any claim of personal injury or death associated with such unintended or unauthorized use, even if such claim alleges that **onsemi** was negligent regarding the design or manufacture of the part. **onsemi** is an Equal Opportunity/Affirmative Action Employer. This literature is subject to all applicable copyright laws and is not for resale in any manner. Other names and brands may be claimed as the property of others.

# NCP4421, NCP4422

## 9.0 A High-Speed MOSFET Drivers

The NCP4421/4422 are high current buffer/drivers capable of driving large MOSFETs and IGBTs.

They are essentially immune to any form of upset except direct overvoltage or over-dissipation – they cannot be latched under any conditions within their power and voltage ratings; they are not subject to damage or improper operation when up to 5.0 V of ground bounce is present on their ground terminals; they can accept, without either damage or logic upset, more than 1.0 A inductive current of either polarity being forced back into their outputs. In addition, all terminals are fully protected against up to 4.0 kV of electrostatic discharge.

The inputs may be driven directly from either TTL or CMOS (3.0 V to 18 V). In addition, 300 mV of hysteresis is built into the input, providing noise immunity and allowing the device to be driven from slowly rising or falling waveforms.

### Features

- Tough CMOS™ Construction
- High Peak Output Current (9.0 A)
- High Continuous Output Current (2.0 A Max)
- Fast Rise and Fall Times:
  - 30 ns with 4,700 pF Load
  - 180 ns with 47,000 pF Load
- Short Internal Delays (30 nsec Typ)
- Low Output Impedance (1.4 Ω Typ)

### Applications

- Line Drivers for Extra-Heavily-Loaded Lines
- Pulse Generators
- Driving the Largest MOSFETs and IGBTs
- Local Power ON/OFF Switch
- Motor and Solenoid Driver

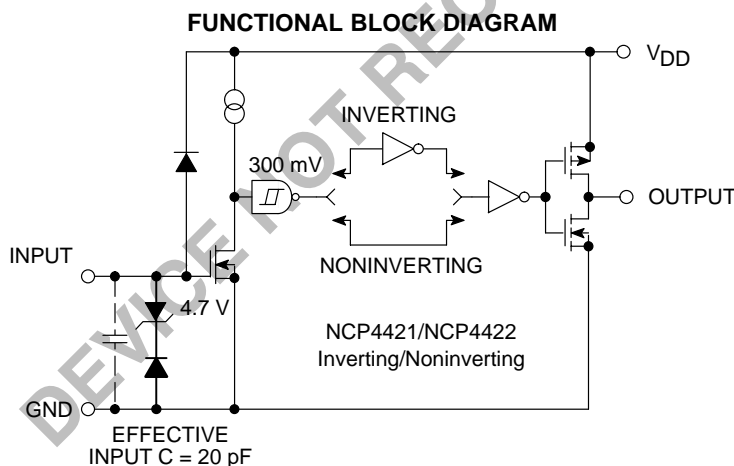

**ON Semiconductor®**

<http://onsemi.com>

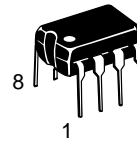

PDIP-8  
P SUFFIX  
CASE 626

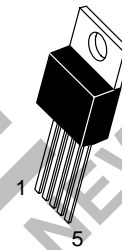

TO-220  
T SUFFIX  
CASE 314D

### PIN CONNECTIONS

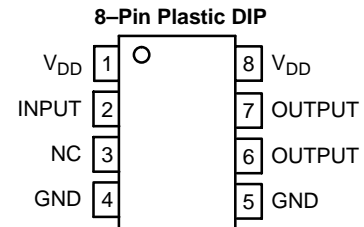

### 5-Pin TO-220

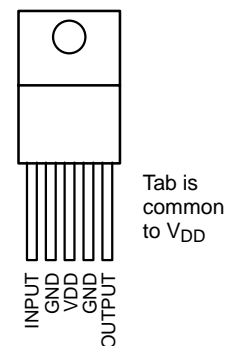

NOTE: Duplicate pins must *both* be connected for proper operation.  
NC = No connection

### ORDERING INFORMATION

See detailed ordering and shipping information in the package dimensions section on page 8 of this data sheet.

### DEVICE MARKING INFORMATION

See general marking information in the device marking section on page 8 of this data sheet.

# NCP4421, NCP4422

## ABSOLUTE MAXIMUM RATINGS\*

Rating	Symbol	Value	Unit
Power Dissipation ( $T_A \leq 70^\circ\text{C}$ ) PDIP 5-Pin TO-220	-	730 1.6	W
Power Dissipation ( $T_C \leq 25^\circ\text{C}$ ) 5-Pin TO-220 (With Heat Sink)	-	12.5	W
Derating Factors (To Ambient) PDIP 5-Pin TO-220	-	8.0 12	mW/°C
Thermal Impedance (To Case) 5-Pin TO-220 $R_{\theta JC}$	-	10	°C/W
Storage Temperature	$T_{stg}$	-65 to +150	°C
Operating Temperature (Chip)	-	150	°C
Operating Temperature (Ambient) TO-220 Version PDIP Version	-	0 to +70 -40 to +85	°C
Lead Temperature (10 Seconds)	-	300	°C
Supply Voltage	$V_{CC}$	20	V
Input Voltage	-	$V_{DD} + 3.0$ to GND -5.0	V
Input Current ( $V_{IN} > V_{DD}$ )	-	50	mA

\*Static-sensitive device. Unused devices must be stored in conductive material. Protect devices from static discharge and static fields. Stresses above those listed under Absolute Maximum Ratings may cause permanent damage to the device. These are stress ratings only and functional operation of the device at these or any other conditions above those indicated in the operational sections of the specifications is not implied. Exposure to Absolute Maximum Rating Conditions for extended periods may affect device reliability.

## ELECTRICAL CHARACTERISTICS ( $T_A = 25^\circ\text{C}$ with $4.5\text{ V} \leq V_{DD} \leq 18\text{ V}$ unless otherwise specified.)

Characteristics	Test Conditions	Symbol	Min	Typ	Max	Unit
<b>Input</b>						
Logic 1 Input Voltage	-	$V_{IH}$	2.4	1.8	-	V
Logic 0 Input Voltage	-	$V_{IL}$	-	1.3	0.8	V
Input Current	$0\text{ V} \leq V_{IN} \leq V_{DD}$	$I_{IN}$	-10	-	10	$\mu\text{A}$
<b>Output</b>						
High Output Voltage	See Figure 1	$V_{OH}$	$V_{DD} - 0.025$	-	-	V
Low Output Voltage	See Figure 1	$V_{OL}$	-	-	0.025	V
Output Resistance, High	$V_{DD} = 18\text{ V}, I_O = 10\text{ mA}$	$R_O$	-	1.4	-	$\Omega$
Output Resistance, Low	$V_{DD} = 18\text{ V}, I_O = 10\text{ mA}$	$R_O$	-	0.9	1.7	$\Omega$
Peak Output Current	$V_{DD} = 18\text{ V}$	$I_{PK}$	-	9.0	-	A
Continuous Output Current	$10\text{ V} \leq V_{DD} \leq 18\text{ V}, T_C = 25^\circ$ (TC4421/22 CAT only)	$I_{DC}$	2.0	-	-	A
Latch-Up Protection	Duty Cycle $\leq 2\%$ Withstand Reverse Current	$I_{REV}$	$> 1500$ $t \leq 300\ \mu\text{s}$	-	-	mA
<b>Switching Time (Note 1)</b>						
Rise Time	Figure 1, $C_L = 10,000\text{ pF}$	$t_R$	-	60	75	nsec
Fall Time	Figure 1, $C_L = 10,000\text{ pF}$	$t_F$	-	60	75	nsec
Delay Time	Figure 1	$t_{D1}$	-	30	60	nsec
Delay Time	Figure 1	$t_{D2}$	-	33	60	nsec

1. Switching times guaranteed by design.

## NCP4421, NCP4422

### ELECTRICAL CHARACTERISTICS (continued) ( $T_A = 25^\circ\text{C}$ with $4.5\text{ V} \leq V_{DD} \leq 18\text{ V}$ unless otherwise specified.)

Characteristics	Test Conditions	Symbol	Min	Typ	Max	Unit
<b>Power Supply</b>						
Power Supply Current	$V_{IN} = 3.0\text{ V}$ $V_{IN} = 0\text{ V}$	$I_S$	– –	0.2 55	1.5 150	mA $\mu\text{A}$
Operating Input Voltage	–	$V_{DD}$	4.5	–	18	V

#### Input

Logic 1 Input Voltage	–	$V_{IH}$	2.4	–	–	V
Logic 0 Input Voltage	–	$V_{IL}$	–	–	0.8	V
Input Current	$0\text{ V} \leq V_{IN} \leq V_{DD}$	$I_{IN}$	–10	–	10	$\mu\text{A}$

### ELECTRICAL CHARACTERISTICS (Measured over operating temperature range with $4.5\text{ V} \leq V_S \leq 18\text{ V}$ unless otherwise specified.)

Characteristics	Test Conditions	Symbol	Min	Typ	Max	Unit
<b>Input</b>						
Logic 1 Input Voltage	–	$V_{IH}$	2.4	–	–	V
Logic 0 Input Voltage	–	$V_{IL}$	–	–	0.8	V
Input Current	$0\text{ V} \leq V_{IN} \leq V_{DD}$	$I_{IN}$	–10	–	10	$\mu\text{A}$

#### Output

High Output Voltage	See Figure 1	$V_{OH}$	$V_{DD} - 0.025$	–	–	V
Low Output Voltage	See Figure 1	$V_{OL}$	–	–	0.025	V
Output Resistance, High	$V_{DD} = 18\text{ V}, I_O = 10\text{ mA}$	$R_O$	–	2.4	3.6	$\Omega$
Output Resistance, Low	$V_{DD} = 18\text{ V}, I_O = 10\text{ mA}$	$R_O$	–	1.8	2.7	$\Omega$

#### Switching Time (Note 1)

Rise Time	Figure 1, $C_L = 10,000\text{ pF}$	$t_R$	–	60	120	nsec
Fall Time	Figure 1, $C_L = 10,000\text{ pF}$	$t_F$	–	60	120	nsec
Delay Time	Figure 1	$t_{D1}$	–	50	80	nsec
Delay Time	Figure 1	$t_{D2}$	–	65	80	nsec

#### Power Supply

Power Supply Current	$V_{IN} = 3.0\text{ V}$ $V_{IN} = 0\text{ V}$	$I_S$	– –	0.45 0.06	3.0 0.2	mA
Operating Input Voltage	–	$V_{DD}$	4.5	–	18	V

1. Switching times guaranteed by design.

# NCP4421, NCP4422

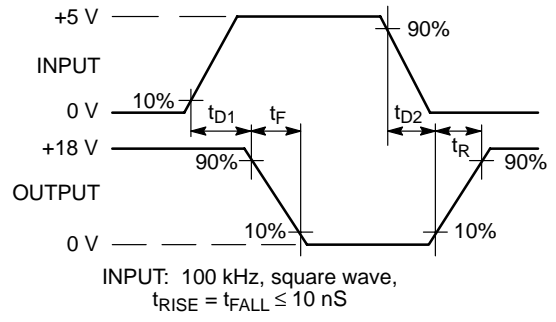
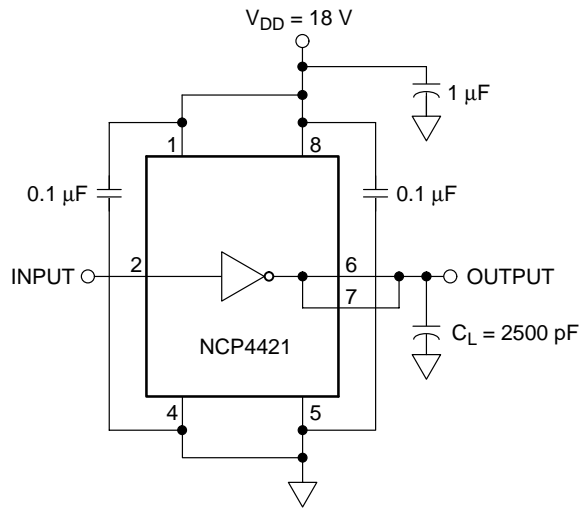

Figure 1. Switching Time Test Circuit

ARCHIVE  
DEVICE NOT RECOMMENDED FOR NEW DESIGN

TYPICAL ELECTRICAL CHARACTERISTICS

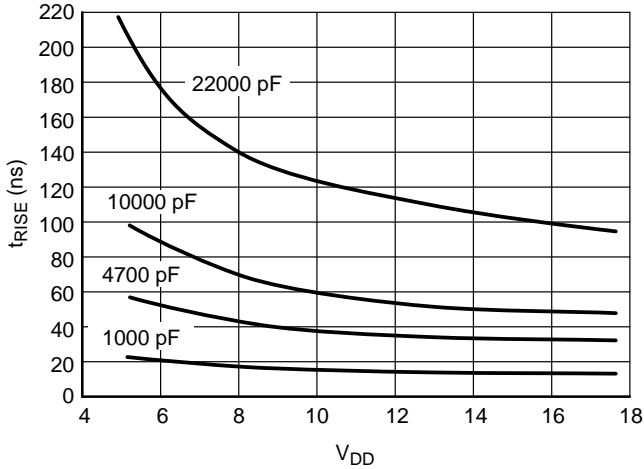

Figure 2. Rise Time vs. Supply Voltage

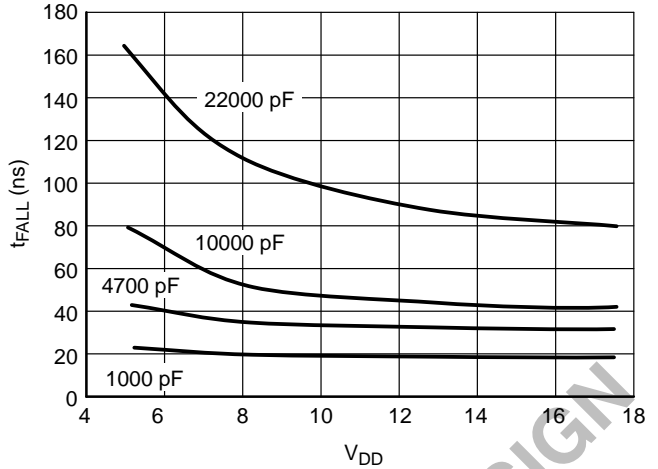

Figure 3. Fall Time vs. Supply Voltage

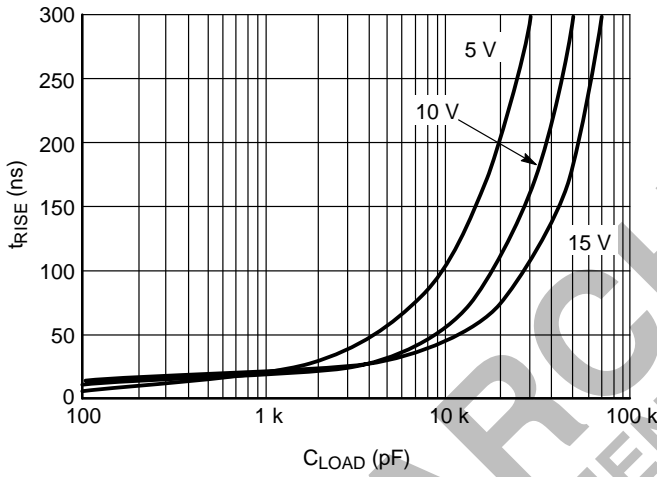

Figure 4. Rise Time vs. Capacitive Load

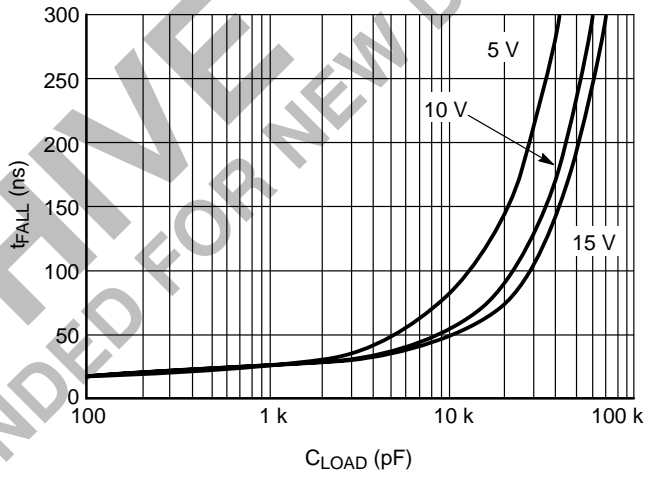

Figure 5. Fall Time vs. Capacitive Load

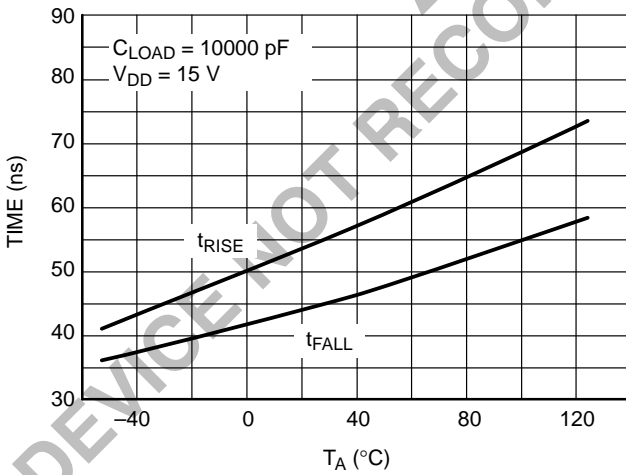

Figure 6. Rise and Fall Times vs. Temperature

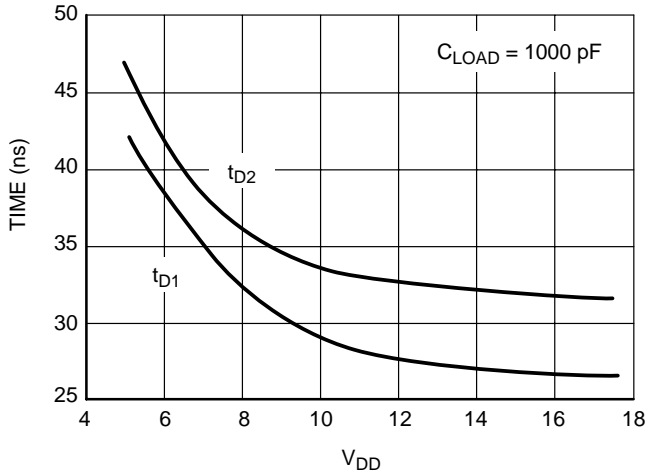

Figure 7. Propagation Delay vs. Supply Voltage

TYPICAL ELECTRICAL CHARACTERISTICS

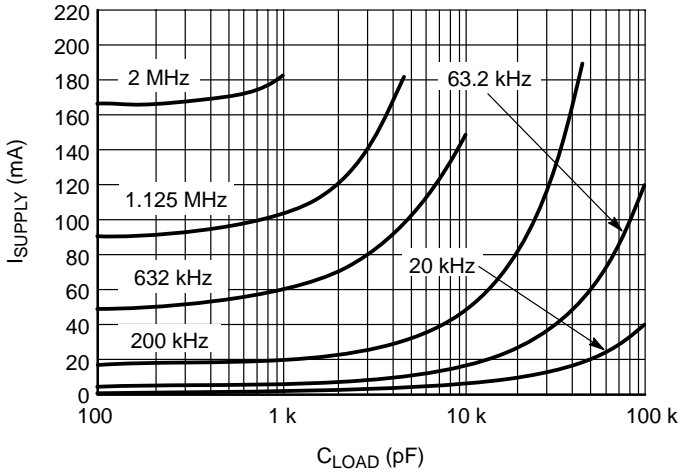

Figure 8. Supply Current vs. Capacitive Load ( $V_{DD} = 18\text{ V}$ )

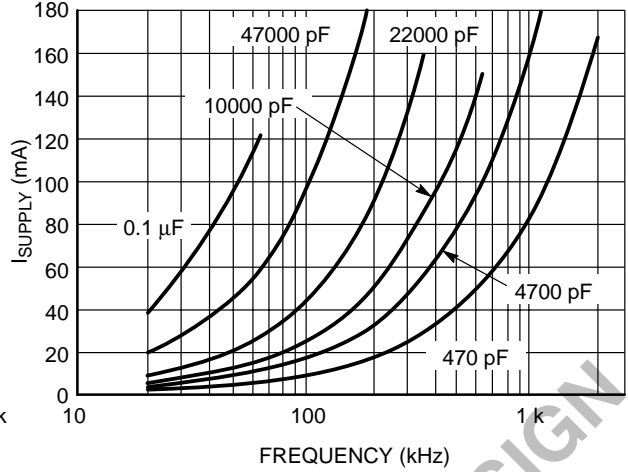

Figure 9. Supply Current vs. Frequency ( $V_{DD} = 18\text{ V}$ )

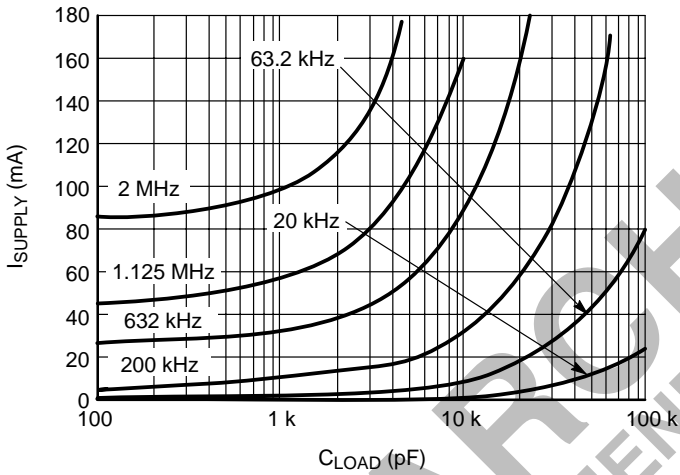

Figure 10. Supply Current vs. Capacitive Load ( $V_{DD} = 12\text{ V}$ )

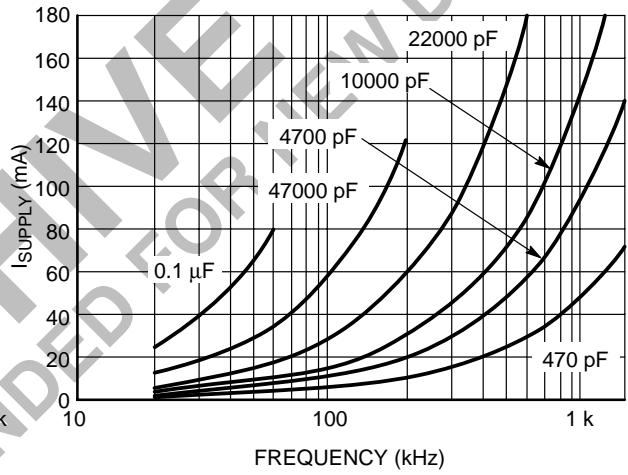

Figure 11. Supply Current vs. Frequency ( $V_{DD} = 12\text{ V}$ )

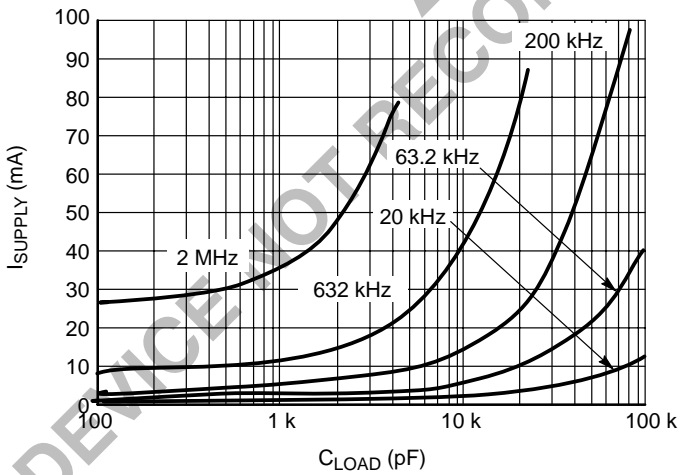

Figure 12. Supply Current vs. Capacitive Load ( $V_{DD} = 6\text{ V}$ )

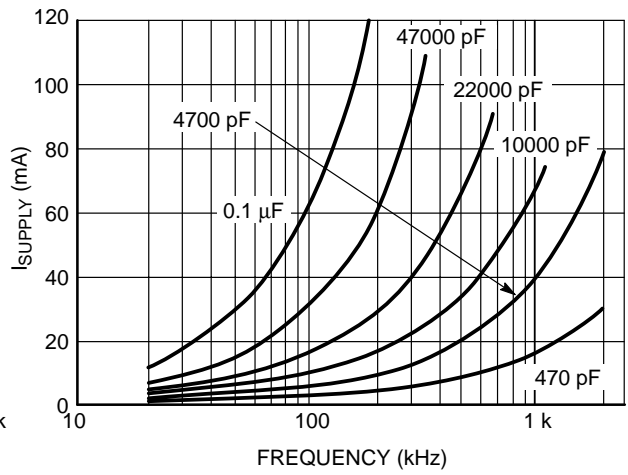

Figure 13. Supply Current vs. Frequency ( $V_{DD} = 6\text{ V}$ )

TYPICAL ELECTRICAL CHARACTERISTICS

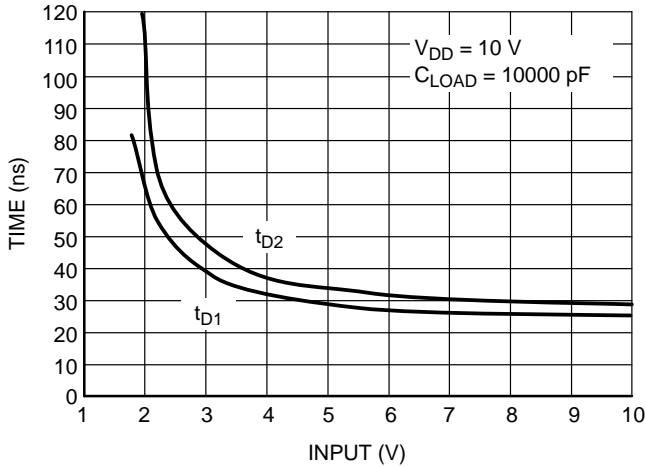

Figure 14. Propagation Delay vs. Input Amplitude

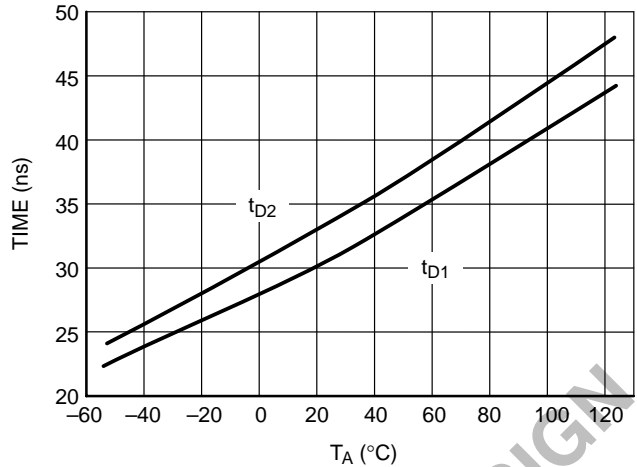

Figure 15. Propagation Delay vs. Temperature

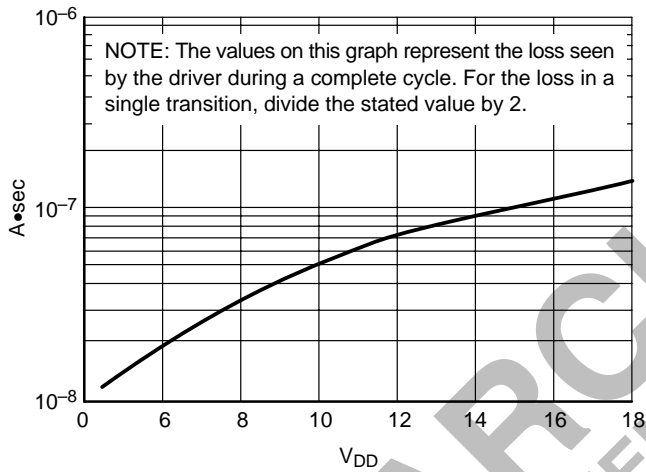

Figure 16. Crossover Energy vs. Supply Voltage

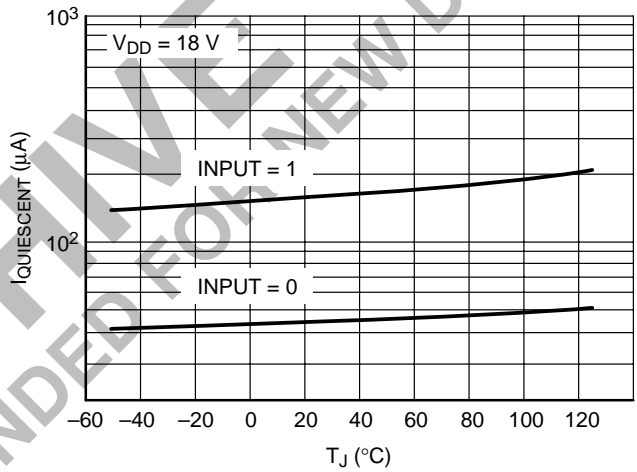

Figure 17. Quiescent Supply Current vs. Temperature

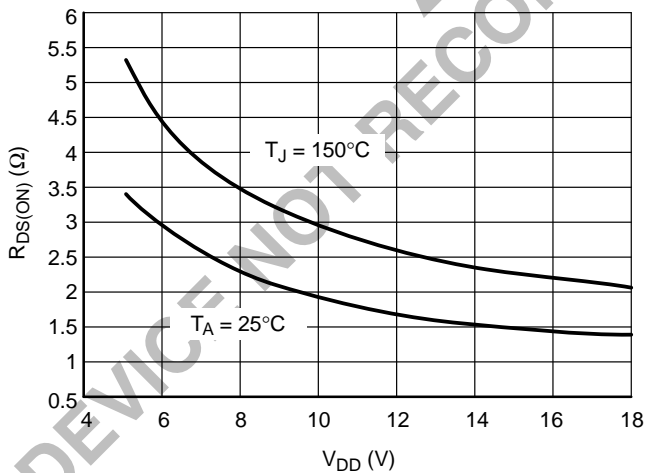

Figure 18. High-State Output Resistance vs. Supply Voltage

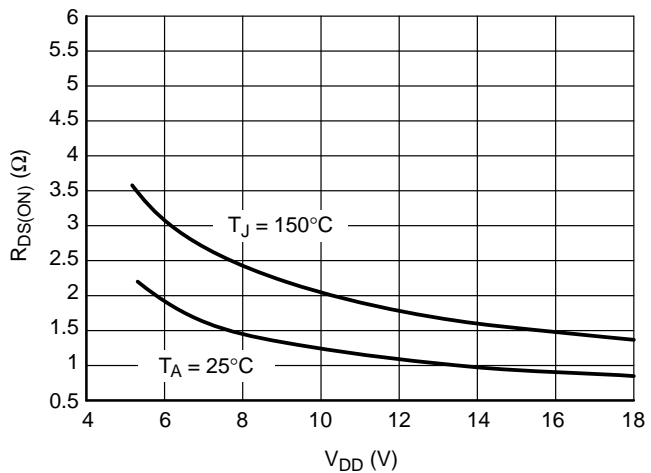
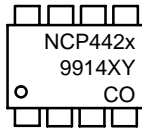

Figure 19. Low-State Output Resistance vs. Supply Voltage



# NCP4421, NCP4422

## MARKING DIAGRAMS



x = 1 or 2  
X = Assembly ID Code  
Y = Year  
CO = Country of Origin

## ORDERING INFORMATION

Device	Package	Temperature Range	Shipping
NCP4421T	5-Pin TO-220	0°C to + 70°C	50 Units/Rail
NCP4421P	8-Pin PDIP	-40°C to + 85°C	50 Units/Rail
NCP4422T	5-Pin TO-220	0°C to + 70°C	50 Units/Rail
NCP4422P	8-Pin PDIP	-40°C to + 85°C	50 Units/Rail

ARCHIVED  
DEVICE NOT RECOMMENDED FOR NEW DESIGN

**Notes**

**ARCHIVE**  
DEVICE NOT RECOMMENDED FOR NEW DESIGN

**Notes**

**ARCHIVE**  
DEVICE NOT RECOMMENDED FOR NEW DESIGN

# NCP4421, NCP4422

## PACKAGE DIMENSIONS

PDIP  
P SUFFIX  
CASE 626-05  
ISSUE K

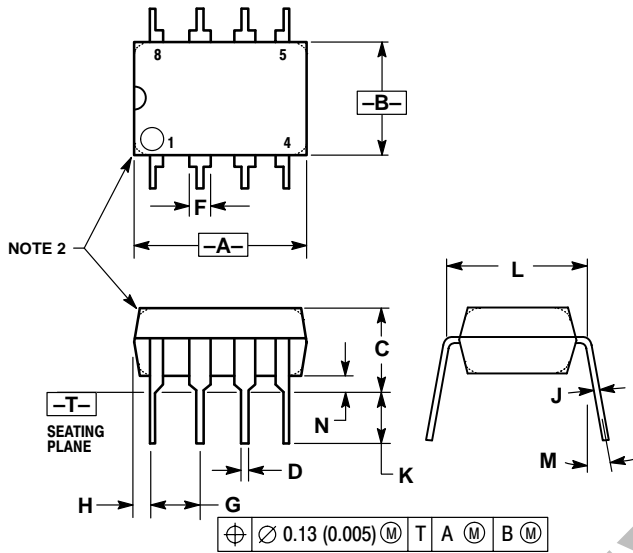

NOTES:

1. DIMENSION L TO CENTER OF LEAD WHEN FORMED PARALLEL.
2. PACKAGE CONTOUR OPTIONAL (ROUND OR SQUARE CORNERS).
3. DIMENSIONING AND TOLERANCING PER ANSI Y14.5M, 1982.

DIM	MILLIMETERS		INCHES	
	MIN	MAX	MIN	MAX
A	9.40	10.16	0.370	0.400
B	6.10	6.60	0.240	0.260
C	3.94	4.45	0.155	0.175
D	0.38	0.51	0.015	0.020
F	1.02	1.78	0.040	0.070
G	2.54 BSC		0.100 BSC	
H	0.76	1.27	0.030	0.050
J	0.20	0.30	0.008	0.012
K	2.92	3.43	0.115	0.135
L	7.62 BSC		0.300 BSC	
M	---	10°	---	10°
N	0.76	1.01	0.030	0.040

TO-220  
T SUFFIX  
CASE 314D-04  
ISSUE E

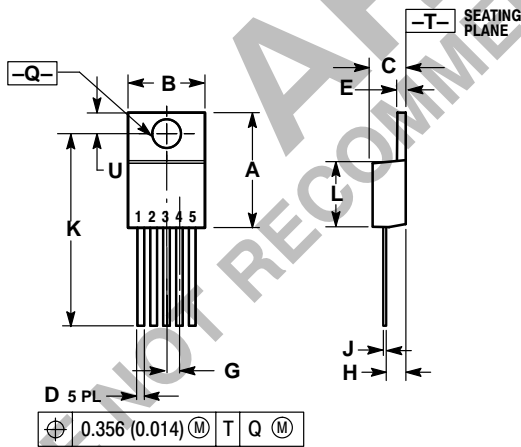

NOTES:

1. DIMENSIONING AND TOLERANCING PER ANSI Y14.5M, 1982.
2. CONTROLLING DIMENSION: INCH.
3. DIMENSION D DOES NOT INCLUDE INTERCONNECT BAR (DAMBAR) PROTRUSION. DIMENSION D INCLUDING PROTRUSION SHALL NOT EXCEED 10.92 (0.043) MAXIMUM.

DIM	INCHES		MILLIMETERS	
	MIN	MAX	MIN	MAX
A	0.572	0.613	14.529	15.570
B	0.390	0.415	9.906	10.541
C	0.170	0.180	4.318	4.572
D	0.025	0.038	0.635	0.965
E	0.048	0.055	1.219	1.397
G	0.067 BSC		1.702 BSC	
H	0.087	0.112	2.210	2.845
J	0.015	0.025	0.381	0.635
K	0.990	1.045	25.146	26.543
L	0.320	0.365	8.128	9.271
Q	0.140	0.153	3.556	3.886
U	0.105	0.117	2.667	2.972

ARCHIVE  
RECOMMENDED FOR NEW DESIGN

**ON Semiconductor** and  are registered trademarks of Semiconductor Components Industries, LLC (SCILLC). SCILLC reserves the right to make changes without further notice to any products herein. SCILLC makes no warranty, representation or guarantee regarding the suitability of its products for any particular purpose, nor does SCILLC assume any liability arising out of the application or use of any product or circuit, and specifically disclaims any and all liability, including without limitation special, consequential or incidental damages. "Typical" parameters which may be provided in SCILLC data sheets and/or specifications can and do vary in different applications and actual performance may vary over time. All operating parameters, including "Typicals" must be validated for each customer application by customer's technical experts. SCILLC does not convey any license under its patent rights nor the rights of others. SCILLC products are not designed, intended, or authorized for use as components in systems intended for surgical implant into the body, or other applications intended to support or sustain life, or for any other application in which the failure of the SCILLC product could create a situation where personal injury or death may occur. Should Buyer purchase or use SCILLC products for any such unintended or unauthorized application, Buyer shall indemnify and hold SCILLC and its officers, employees, subsidiaries, affiliates, and distributors harmless against all claims, costs, damages, and expenses, and reasonable attorney fees arising out of, directly or indirectly, any claim of personal injury or death associated with such unintended or unauthorized use, even if such claim alleges that SCILLC was negligent regarding the design or manufacture of the part. SCILLC is an Equal Opportunity/Affirmative Action Employer.

## PUBLICATION ORDERING INFORMATION

### Literature Fulfillment:

Literature Distribution Center for ON Semiconductor  
P.O. Box 5163, Denver, Colorado 80217 USA  
**Phone:** 303-675-2175 or 800-344-3860 Toll Free USA/Canada  
**Fax:** 303-675-2176 or 800-344-3867 Toll Free USA/Canada  
**Email:** ONlit@hibbertco.com

**N. American Technical Support:** 800-282-9855 Toll Free USA/Canada

**JAPAN:** ON Semiconductor, Japan Customer Focus Center  
2-9-1 Kamimeguro, Meguro-ku, Tokyo, Japan 153-0051  
**Phone:** 81-3-5773-3850  
**Email:** r14525@onsemi.com

**ON Semiconductor Website:** <http://onsemi.com>

For additional information, please contact your local Sales Representative.