

50 mA AND 100 mA CMOS LDOs WITH SHUTDOWN

FEATURES

- Zero Ground Current for Longer Battery Life!
- Very Low Dropout Voltage
- Guaranteed 50 mA, 100 mA Output (TC1223, TC1224, Respectively)
- High Output Voltage Accuracy
- Standard or Custom Output Voltages
- Power-Saving Shutdown Mode
- Over-Current and Over-Temperature Protection
- Space-Saving SOT-23A-5 Package
- Pin Compatible Upgrades for Bipolar Regulators

APPLICATIONS

- Battery Operated Systems
- Portable Computers
- Medical Instruments
- Instrumentation
- Cellular / GSM / PHS Phones
- Linear Post-Regulator for SMPS
- Pagers

TYPICAL APPLICATION

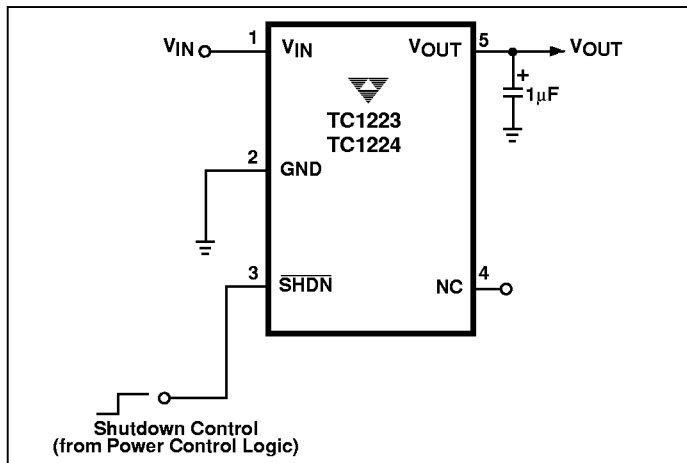

PIN CONFIGURATION

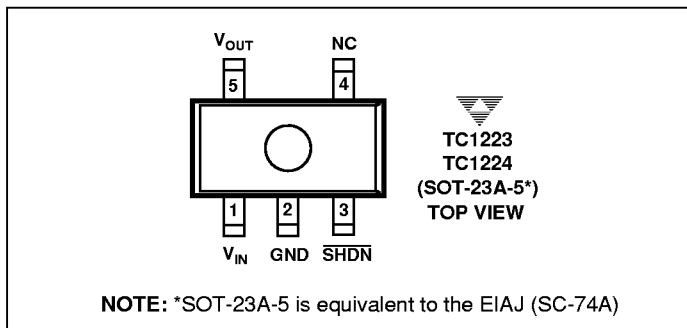

GENERAL DESCRIPTION

The TC1223 and TC1224 are high accuracy (typically $\pm 0.5\%$) CMOS upgrade for older (bipolar) low dropout regulators such as the LP2980. Designed specifically for battery-operated systems, the devices CMOS construction eliminates wasted ground current, significantly extending battery life. Total supply current is typically $50 \mu\text{A}$ at full load (*20 to 60 times lower than in bipolar regulators!*).

Key features for the TC1223 and TC1224 include ultra low-noise operation; very low dropout voltage (typically 85 mV and 180 mV, respectively, at full load) and fast response to step changes in load. Supply current is reduced to $0.5 \mu\text{A}$ (max) and V_{OUT} falls to zero when the shutdown input is low. The devices also incorporate both over-temperature and over-current protection.

The TC1223 and TC1224 are stable with an output capacitor of only $1 \mu\text{F}$ and have a maximum output current of 50 mA and 100 mA, respectively. For higher output versions, please see the TC1107, TC1108, and TC1173 ($I_{\text{OUT}} = 300 \text{ mA}$) data sheets.

ORDERING INFORMATION

Part No.	Output Voltage ** (V)	Package	Junction Temp. Range
TC1223-2.5VCT	2.5	SOT-23A-5*	-40°C to +125°C
TC1223-2.7VCT	2.7	SOT-23A-5*	-40°C to +125°C
TC1223-2.8VCT	2.8	SOT-23A-5*	-40°C to +125°C
TC1223-2.85VCT	2.85	SOT-23A-5*	-40°C to +125°C
TC1223-3.0VCT	3.0	SOT-23A-5*	-40°C to +125°C
TC1223-3.3VCT	3.3	SOT-23A-5*	-40°C to +125°C
TC1223-3.6VCT	3.6	SOT-23A-5*	-40°C to +125°C
TC1223-4.0VCT	4.0	SOT-23A-5*	-40°C to +125°C
TC1223-5.0VCT	5.0	SOT-23A-5*	-40°C to +125°C
TC1224-2.5VCT	2.5	SOT-23A-5*	-40°C to +125°C
TC1224-2.7VCT	2.7	SOT-23A-5*	-40°C to +125°C
TC1224-2.8VCT	2.8	SOT-23A-5*	-40°C to +125°C
TC1224-2.85VCT	2.85	SOT-23A-5*	-40°C to +125°C
TC1224-3.0VCT	3.0	SOT-23A-5*	-40°C to +125°C
TC1224-3.3VCT	3.3	SOT-23A-5*	-40°C to +125°C
TC1224-3.6VCT	3.6	SOT-23A-5*	-40°C to +125°C
TC1224-4.0VCT	4.0	SOT-23A-5*	-40°C to +125°C
TC1224-5.0VCT	5.0	SOT-23A-5*	-40°C to +125°C

NOTE: *SOT-23A-5 is equivalent to the EIAJ (SC-74A)

** Other output voltages available. Contact TelCom for details

50 mA AND 100 mA CMOS LDOs WITH SHUTDOWN

TC1223
TC1224

ABSOLUTE MAXIMUM RATINGS*

Input Voltage	6.5V
Output Voltage	(- 0.3) to (V _{IN} + 0.3)
Power Dissipation	Internally Limited
Operating Temperature	- 40°C < T _J < 125°C
Storage Temperature	- 65°C to +150°C
Maximum Voltage On Any Pin	V _{IN} + 0.3V to - 0.3V

Lead Temperature (Soldering, 10 Sec.) +260°C

*Stresses beyond those listed under "Absolute Maximum Ratings" may cause permanent damage to the device. These are stress ratings only, and functional operation of the device at these or any other conditions beyond those indicated in the operational sections of the specifications is not implied. Exposure to absolute maximum rating conditions for extended periods may affect device reliability.

ELECTRICAL CHARACTERISTICS: V_{IN} = V_{OUT} + 1V, I_L = 100 μA, C_L = 3.3 μF, $\overline{\text{SHDN}} > V_{IH}$, T_A = 25°C, unless otherwise noted.
Boldface type specifications apply for junction temperatures of - 40°C to +125°C.

Symbol	Parameter	Test Conditions	Min	Typ	Max	Units
V _{IN}	Input Operating Voltage		—	—	6.0	V
I _{OUTMAX}	Maximum Output Current	TC1223 TC1224	50 100	—	—	mA
V _{OUT}	Output Voltage	Note 1	V_R - 2.5%	V _R ±0.5%	V_R + 2.5%	V
TCV _{OUT}	V _{OUT} Temperature Coefficient	Note 2	—	20 40	—	ppm/°C
ΔV _{OUT} /ΔV _{IN}	Line Regulation	(V _R + 1V) ≤ V _{IN} ≤ 6V	—	0.05	0.35	%
ΔV _{OUT} /V _{OUT}	Load Regulation	I _L = 0.1 mA to I _{OUTMAX} (Note 3)	—	0.5	2	%
V _{IN} - V _{OUT}	Dropout Voltage (Note 4)	I _L = 100 μA I _L = 20 mA I _L = 50 mA I _L = 100 mA (TC1224) (Note 4)	—	2 65 85 180	— — 120 250	mV
I _{IN}	Supply Current (Note 7)	SHDN = V _{IH} , I _L = 0	—	50	80	μA
I _{INSD}	Shutdown Supply Current	SHDN = 0V	—	0.05	0.5	μA
PSRR	Power Supply Rejection Ratio	F _{RE} ≤ 1 KHz	—	64	—	dB
I _{OUTSC}	Output Short Circuit Current	V _{OUT} = 0V	—	300	450	mA
ΔV _{OUT} /ΔP _D	Thermal Regulation	Note 5, 6	—	0.04	—	%/W
T _{SD}	Thermal Shutdown Die Temperature		—	160	—	°C
ΔT _{SD}	Thermal Shutdown Hysteresis		—	10	—	°C
eN	Output Noise	I _L = I _{OUTMAX}	—	260	—	nV/√Hz

SHDN Input

V _{IH}	SHDN Input High Threshold	V _{IN} = 2.5V to 6.5V	45	—	—	%V _{IN}
V _{IL}	SHDN Input Low Threshold	V _{IN} = 2.5V to 6.5V	—	—	15	%V _{IN}

NOTES: 1. V_R is the regulator output voltage setting. V_R = 2.5V, 2.7V, 2.85V, 3.0V, 3.3V, 3.6V, 4.0V, 5.0V.

2. $TCV_{OUT} = \frac{(V_{OUTMAX} - V_{OUTMIN}) \times 10^6}{V_{OUT} \times \Delta T}$

- Regulation is measured at a constant junction temperature using low duty cycle pulse testing. Load regulation is tested over a load range from 1.0 mA to the maximum specified output current. Changes in output voltage due to heating effects are covered by the thermal regulation specification.
- Dropout voltage is defined as the input to output differential at which the output voltage drops 2% below its nominal value at a 1V differential.
- Thermal Regulation is defined as the change in output voltage at a time T after a change in power dissipation is applied, excluding load or line regulation effects. Specifications are for a current pulse equal to I_{LMAX} at V_{IN} = 6V for T = 10 msec.
- The maximum allowable power dissipation is a function of ambient temperature, the maximum allowable junction temperature and the thermal resistance from junction-to-air (i.e. T_A, T_J, θ_{JA}). Exceeding the maximum allowable power dissipation causes the device to initiate thermal shutdown. Please see *Thermal Considerations* section of this data sheet for more details.
- Apply for Junction Temperatures of -40°C to +85°C.

PIN DESCRIPTION

Pin No. (SOT-23A-5)	Symbol	Description
1	V_{IN}	Unregulated supply input.
2	GND	Ground terminal.
3	\overline{SHDN}	Shutdown control input. The regulator is fully enabled when a logic high is applied to this input. The regulator enters shutdown when a logic low is applied to this input. During shutdown, output voltage falls to zero, and supply current is reduced to 0.5 μA (max.).
4	NC	No connect.
5	V_{OUT}	Regulated voltage output.

DETAILED DESCRIPTION

The TC1223 and TC1224 are precision fixed output voltage regulators. Unlike the bipolar regulators, the TC1223 and TC1224 supply current does not increase with load current. In addition, V_{OUT} remains stable and within regulation at very low load currents (an important consideration in RTC and CMOS RAM battery back-up applications).

Figure 1 shows a typical application circuit. The regulator is enabled any time the shutdown input (\overline{SHDN}) is at or above V_{IH} , and shutdown (disabled) when \overline{SHDN} is at or below V_{IL} . \overline{SHDN} may be controlled by a CMOS logic gate, or I/O port of a microcontroller. If the \overline{SHDN} input is not required, it should be connected directly to the input supply. While in shutdown, supply current decreases to 0.05 μA (typical) and V_{OUT} falls to zero volts.

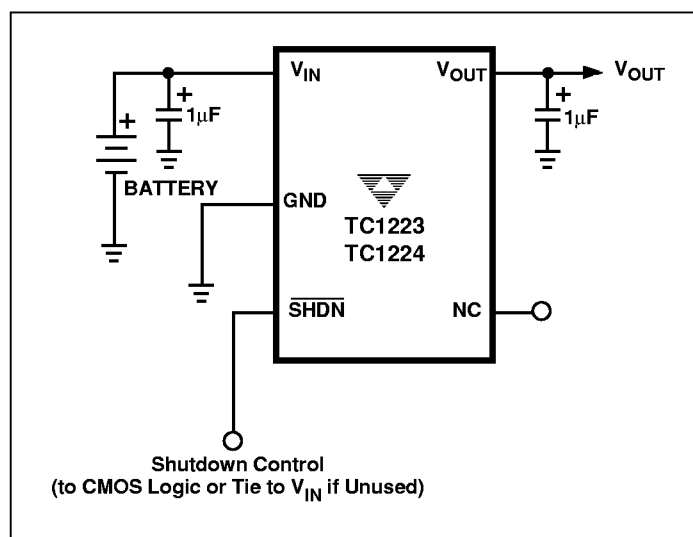

Figure 1. Typical Application Circuit

Output Capacitor

A 1 μF (min) capacitor from V_{OUT} to ground is recommended. The output capacitor should have an effective series resistance of 5 Ω or less, and a resonant frequency above 1 MHz. A 1 μF capacitor should be connected from V_{IN} to GND if there is more than 10 inches of wire between the regulator and the AC filter capacitor, or if a battery is used as the power source. Aluminum electrolytic or tantalum capacitor types can be used. (Since many aluminum electrolytic capacitors freeze at approximately -30°C , solid tantalums are recommended for applications operating below -25°C .) When operating from sources other than batteries, supply-noise rejection and transient response can be improved by increasing the value of the input and output capacitors and employing passive filtering techniques.

Thermal Considerations

Thermal Shutdown

Integrated thermal protection circuitry shuts the regulator off when die temperature exceeds 160°C . The regulator remains off until the die temperature drops to approximately 150°C .

Power Dissipation

The amount of power the regulator dissipates is primarily a function of input and output voltage, and output current. The following equation is used to calculate worst case *actual* power dissipation:

TC1223 TC1224

$$P_D \approx (V_{INMAX} - V_{OUTMIN}) I_{LOADMAX}$$

Where:

P_D = Worst case actual power dissipation

V_{INMAX} = Maximum voltage on V_{IN}

V_{OUTMIN} = Minimum regulator output voltage

$I_{LOADMAX}$ = Maximum output (load) current

Equation 1.

The maximum *allowable* power dissipation (Equation 2) is a function of the maximum ambient temperature (T_{AMAX}), the maximum allowable die temperature (125°C) and the thermal resistance from junction-to-air (θ_{JA}). The SOT-23A-5 package has a θ_{JA} of approximately $220^\circ\text{C}/\text{Watt}$ when mounted on a single layer FR4 dielectric copper clad PC board.

$$P_{D\ MAX} = \frac{(T_{JMAX} - T_{JMAX})}{\theta_{JA}}$$

Where all terms are previously defined.

Equation 2.

Equation 1 can be used in conjunction with Equation 2 to ensure regulator thermal operation is within limits. For example:

Given:

$$V_{INMAX} = 3.0V \pm 10\%$$

$$V_{OUTMIN} = 2.7V - 2.5\%$$

$$I_{LOAD} = 40\ \text{mA}$$

$$T_{AMAX} = 55^\circ\text{C}$$

- Find:
1. Actual power dissipation
 2. Maximum allowable dissipation

Actual power dissipation:

$$\begin{aligned} P_D &\approx (V_{INMAX} - V_{OUTMIN}) I_{LOADMAX} \\ &= [(3.0 \times 1.1) - (2.7 \times .975)] 40 \times 10^{-3} \\ &= 26.7\ \text{mW} \end{aligned}$$

Maximum allowable power dissipation:

$$\begin{aligned} P_{D\ MAX} &= \frac{(T_{JMAX} - T_{AMAX})}{\theta_{JA}} \\ &= \frac{(125 - 55)}{220} \\ &= 318\ \text{mW} \end{aligned}$$

In this example, the TC1223 dissipates a maximum of only 26.7 mW; far below the allowable limit of 318 mW. In a similar manner, Equation 1 and Equation 2 can be used to calculate maximum current and/or input voltage limits.

Layout Considerations

The primary path of heat conduction out of the package is via the package leads. Therefore, layouts having a ground plane, wide traces at the pads, and wide power supply bus lines combine to lower θ_{JA} and, therefore, increase the maximum allowable power dissipation limit.

50 mA and 100 mA CMOS LDOs WITH SHUTDOWN

TC1223
TC1224

TYPICAL CHARACTERISTICS: (Unless otherwise specified, all parts are measured at Temperature = 25°C)

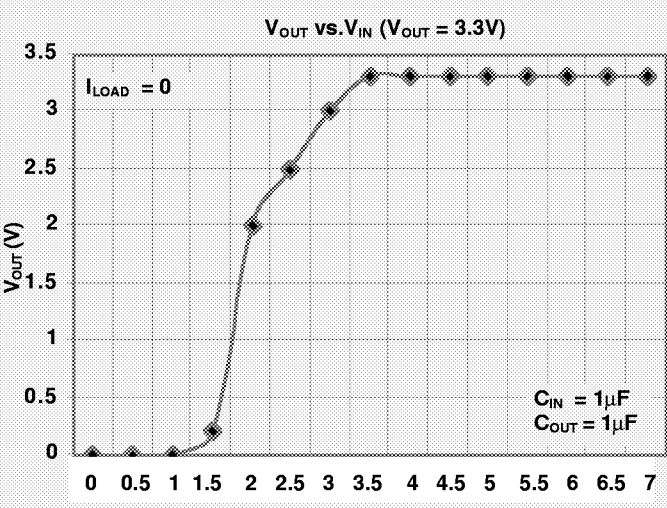
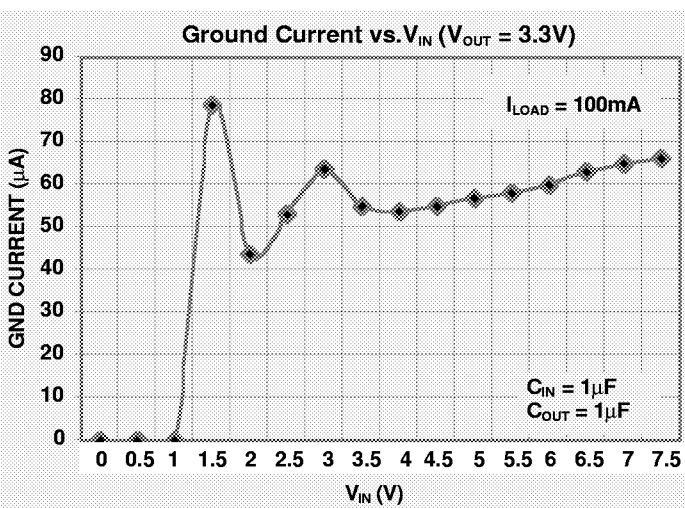
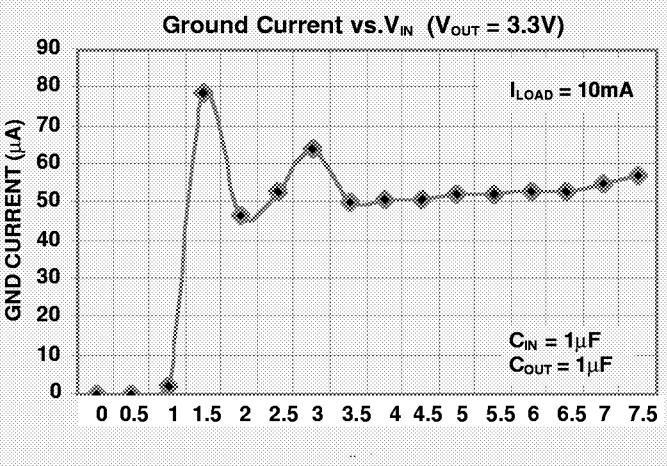
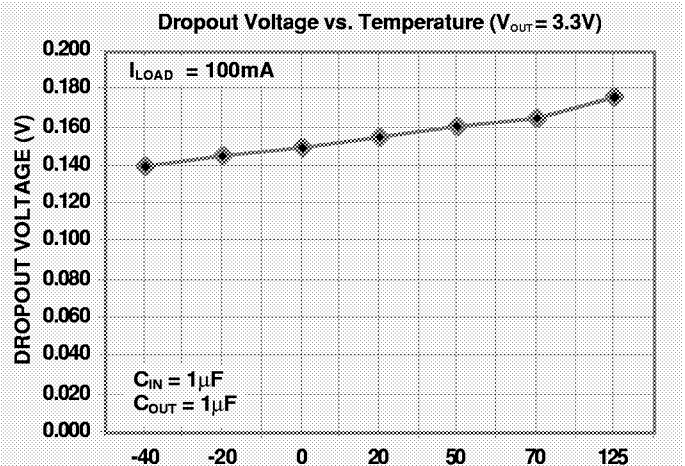
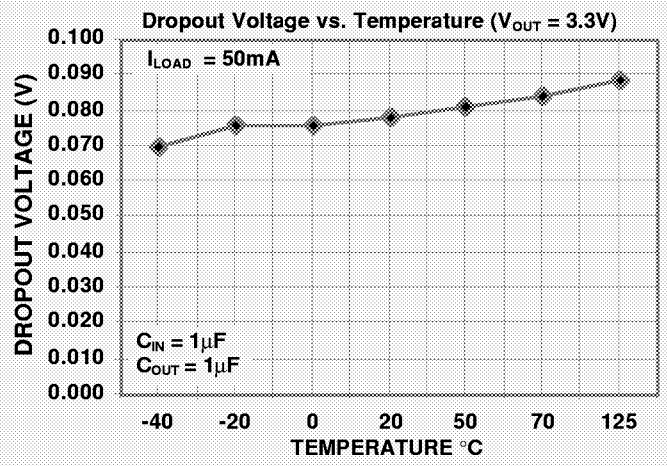
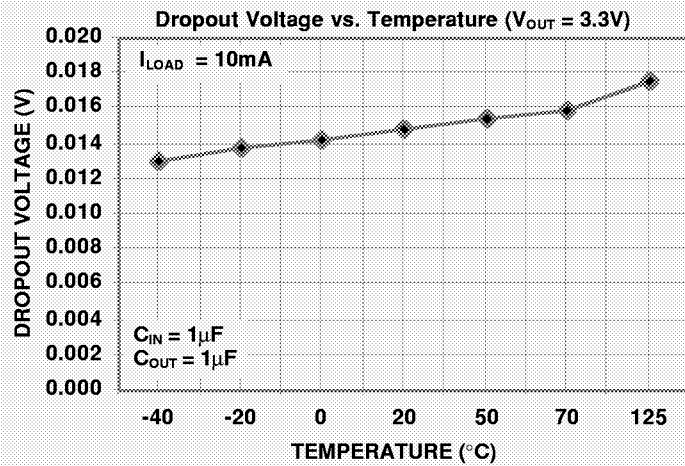

50 mA AND 100 mA CMOS LDOs WITH SHUTDOWN

TC1223
TC1224

TYPICAL CHARACTERISTICS: (Unless otherwise specified, all parts are measured at Temperature = 25°C

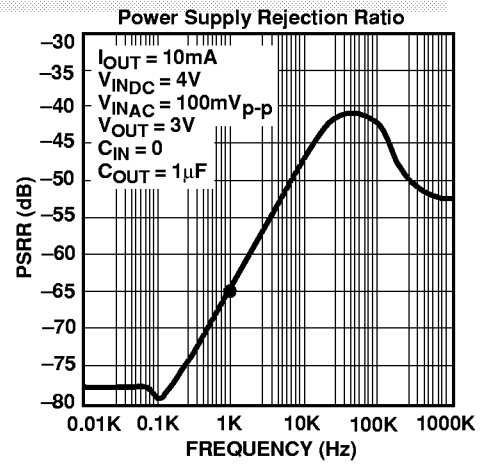
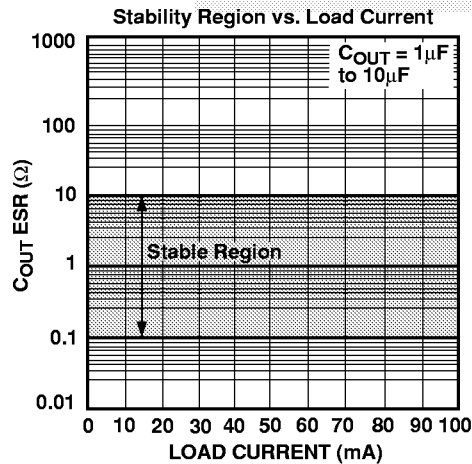
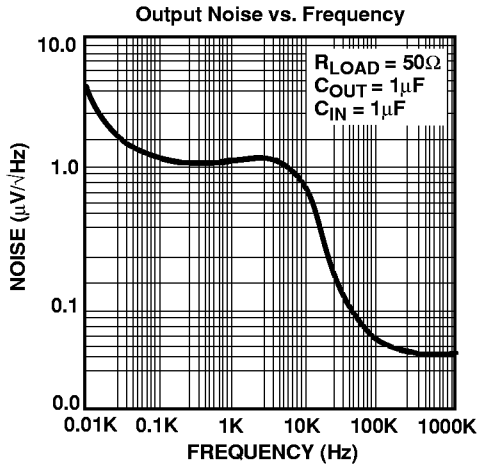
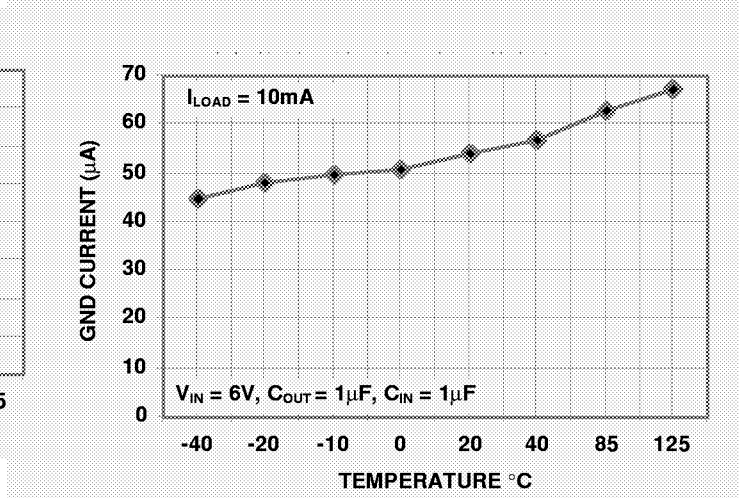
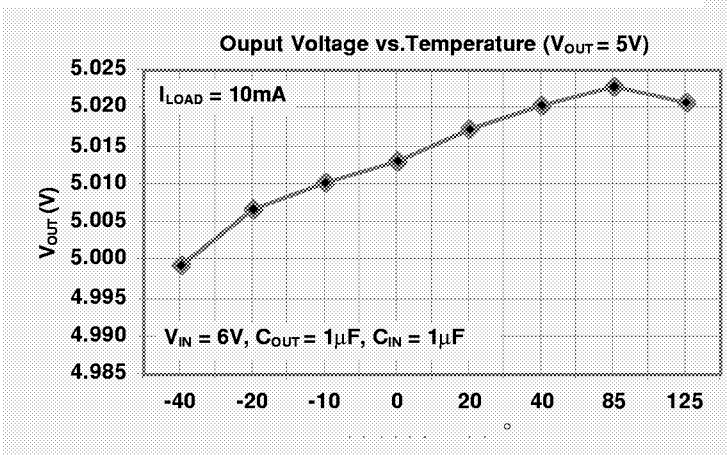
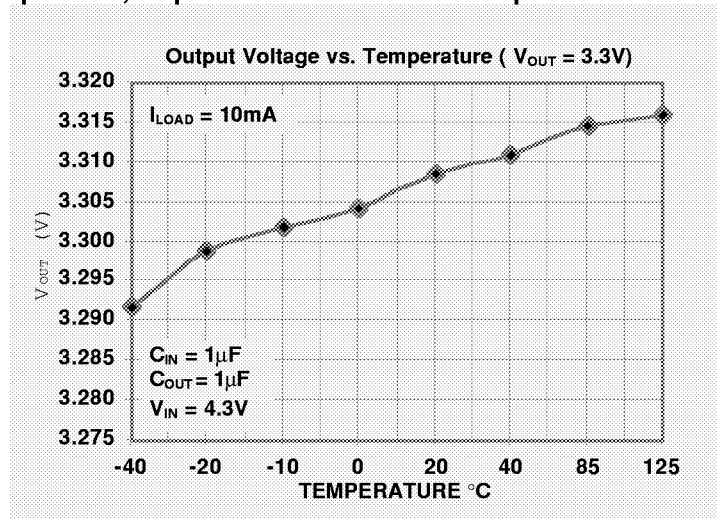
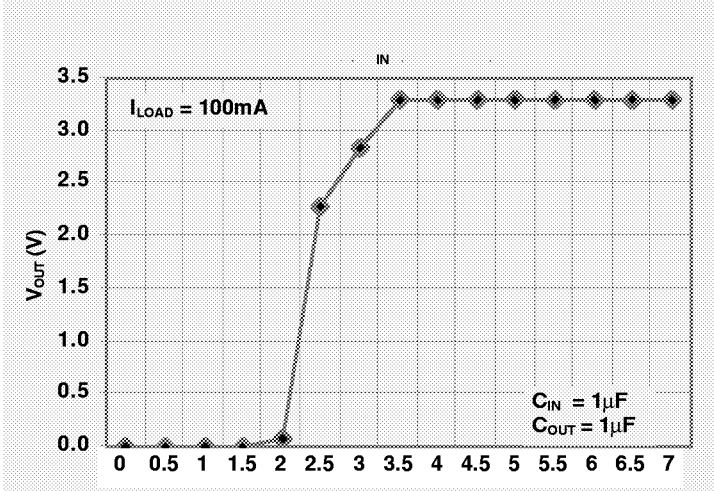

50 mA and 100 mA CMOS LDOs WITH SHUTDOWN

TC1223
TC1224

TYPICAL CHARACTERISTICS

Measure Rise Time of 3.3V LDO

Conditions: $C_{IN} = 1\mu F$, $C_{OUT} = 1\mu F$, $I_{LOAD} = 100mA$, $V_{IN} = 4.3V$,
Temp = 25°C, Rise Time = 184 μS

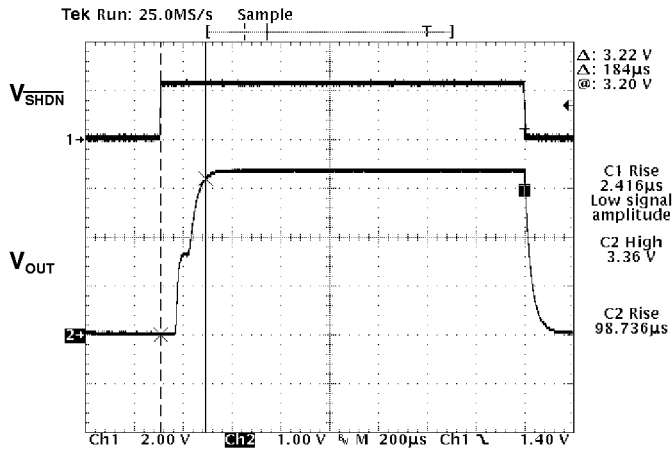

Measure Fall Time of 3.3V LDO

Conditions: $C_{IN} = 1\mu F$, $C_{OUT} = 1\mu F$, $I_{LOAD} = 100mA$, $V_{IN} = 4.3V$,
Temp = 25°C, Fall Time = 52 μS

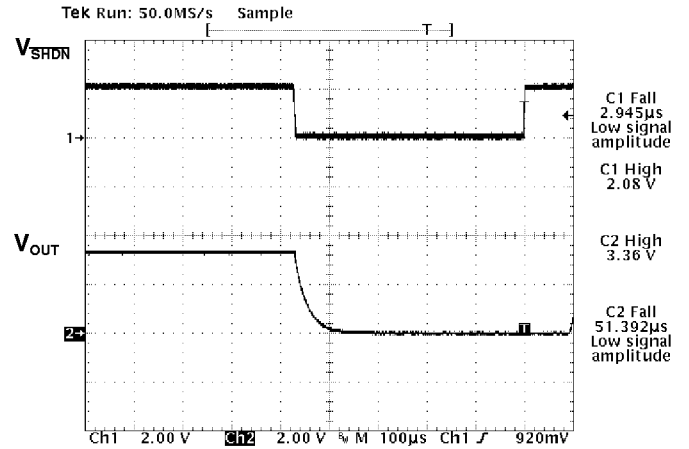

Measure Rise Time of 5.0V LDO

Conditions: $C_{IN} = 1\mu F$, $C_{OUT} = 1\mu F$, $I_{LOAD} = 100mA$, $V_{IN} = 6V$,
Temp = 25°C, Rise Time = 192 μS

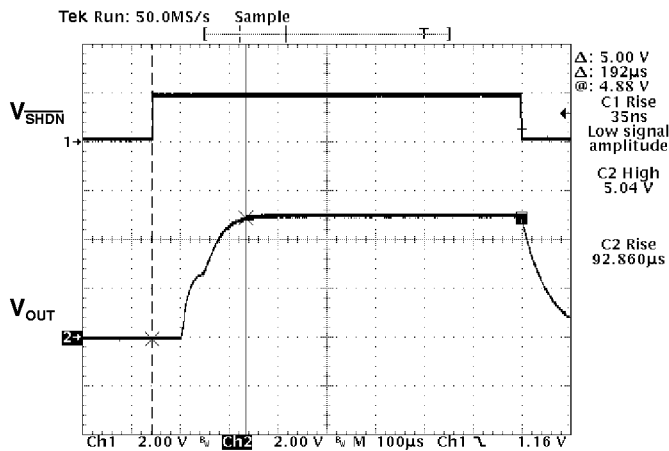

Measure Fall Time of 5.0V LDO

Conditions: $C_{IN} = 1\mu F$, $C_{OUT} = 1\mu F$, $I_{LOAD} = 100mA$, $V_{IN} = 6V$,
Temp = 25°C, Fall Time = 88 μS

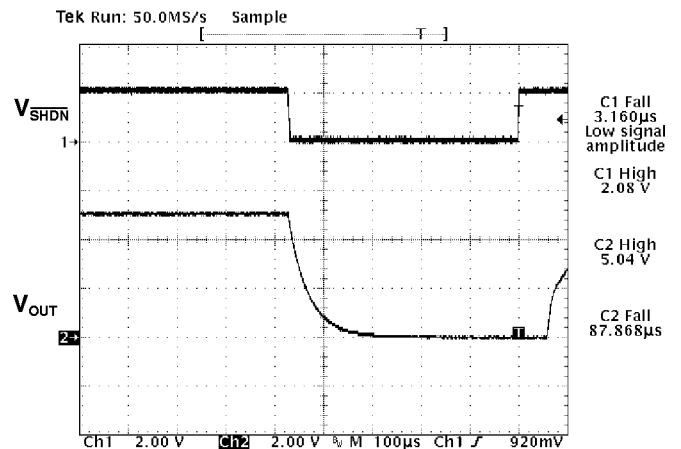

50 mA AND 100 mA CMOS LDOs WITH SHUTDOWN

TC1223
TC1224

TYPICAL CHARACTERISTICS

Thermal Shutdown Response of 5.0V LDO

Conditions: $V_{IN} = 6V, C_{IN} = 0\mu F, C_{OUT} = 1\mu F$

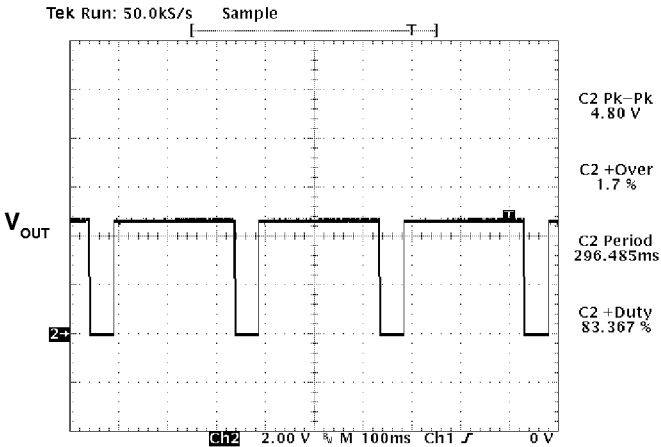

I_{LOAD} was increased until temperature of die reached about 160°C, at which time integrated thermal protection circuitry shuts the regulator off when die temperature exceeds approximately 160°C. The regulator remains off until die temperature drops to approximately 150°C.

MARKING

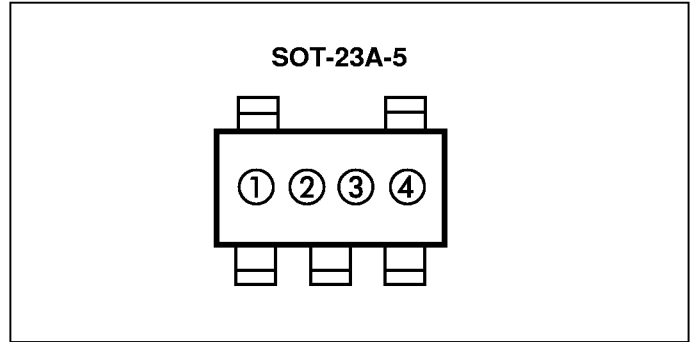

① & ② = part number code + temperature range and voltage

(V)	TC1223 Code	TC1224 Code
2.5	L1	M1
2.7	L2	M2
2.8	LZ	MZ
2.85	L8	M8
3.0	L3	M3
3.3	L5	M5
3.6	L9	M9
4.0	L0	M0
5.0	L7	M7

③ represents year and quarter code

④ represents lot ID number

TAPING FORM

Component Taping Orientation for 5L SOT-23A Devices

Tape and Reel Specifications Table

Package	Carrier Width (W)	Pitch (P)	Part Per Full Reel	Reel Size
5L SOT-23A	8 mm	4 mm	3000	7

50 mA and 100 mA CMOS LDOs WITH SHUTDOWN

**TC1223
TC1224**

PACKAGE DIMENSIONS

SOT-23A-5*

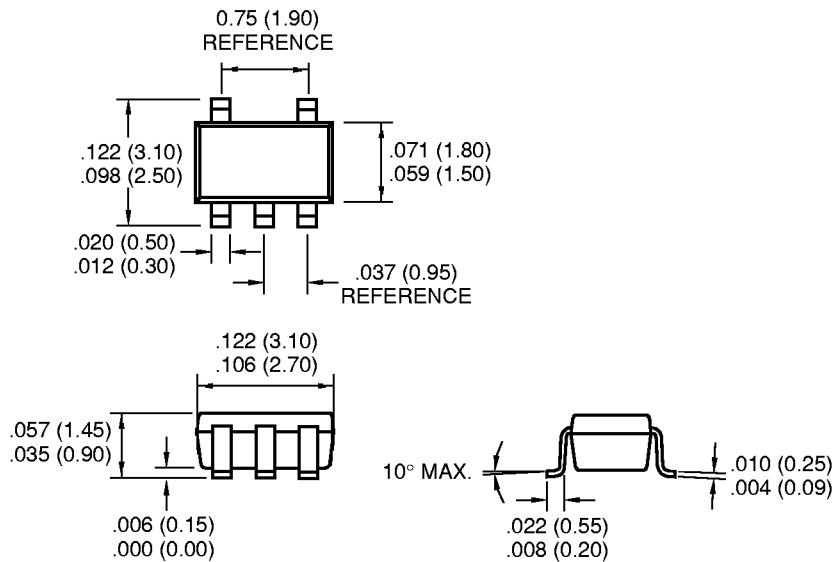

NOTE: *SOT-23A-5 is equivalent to the EIAJ (SC-74A)

Dimensions: inches (mm)

Sales Offices

TelCom Semiconductor, Inc.
1300 Terra Bella Avenue
P.O. Box 7267
Mountain View, CA 94039-7267
TEL: 650-968-9241
FAX: 650-967-1590
E-Mail: liter@telcom-semi.com

TelCom Semiconductor, Inc.
Austin Product Center
8303 MoPac Expressway North
Suite A-201
Austin, TX 78759
TEL: 512-345-2030
FAX: 512-345-6085

TelCom Semiconductor H.K. Ltd.
10 Sam Chuk Street, Ground Floor
San Po Kong, Kowloon
Hong Kong
TEL: 852-2324-0122
FAX: 852-2354-9957