

FEATURES

- Member of the Texas Instruments Widebus™ Family
- Operates From 1.65 V to 3.6 V
- Max t_{pd} of 3 ns at 3.3 V
- ± 24 -mA Output Drive at 3.3 V
- Latch-Up Performance Exceeds 250 mA Per JESD 17
- ESD Protection Exceeds JESD 22
 - 2000-V Human-Body Model (A114-A)
 - 200-V Machine Model (A115-A)
 - 1000-V Charged-Device Model (C101)

DESCRIPTION/ORDERING INFORMATION

This 16-bit buffer/driver is designed for 1.65-V to 3.6-V V_{CC} operation.

The SN74ALVC16244A is designed specifically to improve the performance and density of 3-state memory-address drivers, clock drivers, and bus-oriented receivers and transmitters.

The device can be used as four 4-bit buffers, two 8-bit buffers, or one 16-bit buffer. It provides true outputs and symmetrical active-low output-enable (\overline{OE}) inputs.

To ensure the high-impedance state during power up or power down, \overline{OE} should be tied to V_{CC} through a pullup resistor; the minimum value of the resistor is determined by the current-sinking capability of the driver.

DGG OR DL PACKAGE
(TOP VIEW)

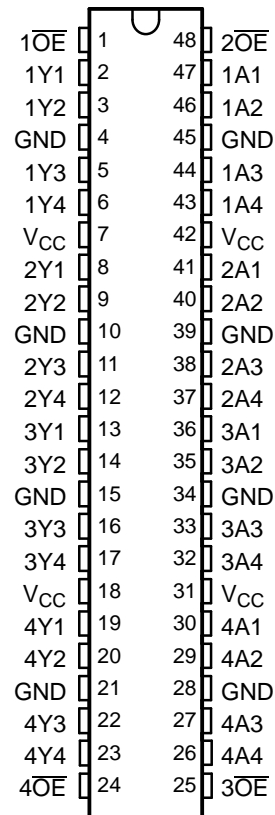

ORDERING INFORMATION

T_A	PACKAGE ⁽¹⁾		ORDERABLE PART NUMBER	TOP-SIDE MARKING
-40°C to 85°C	FBGA – GRD	Tape and reel	SN74ALVC16244AGRDR	VC244A
	FBGA – ZRD (Pb-free)		SN74ALVC16244AZRDR	
	SSOP – DL	Tube	SN74ALVC16244ADL	ALVC16244A
		Tape and reel	SN74ALVC16244ADLR	
	TSSOP – DGG	Tape and reel	SN74ALVC16244ADGGR	ALVC16244A
			SN74ALVC16244ADGGRE4	
VFBGA – GQL	Tape and reel	SN74ALVC16244AGQLR	VC244A	
VFBGA – ZQL (Pb-free)		SN74ALVC16244AZQLR		

(1) Package drawings, standard packing quantities, thermal data, symbolization, and PCB design guidelines are available at www.ti.com/sc/package.



Please be aware that an important notice concerning availability, standard warranty, and use in critical applications of Texas Instruments semiconductor products and disclaimers thereto appears at the end of this data sheet.

Widebus is a trademark of Texas Instruments.

SN74ALVC16244A
16-BIT BUFFER/DRIVER
WITH 3-STATE OUTPUTS

SCAS2500—JANUARY 1993—REVISED OCTOBER 2005

GQL OR ZQL PACKAGE
(TOP VIEW)

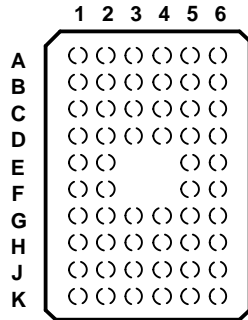

TERMINAL ASSIGNMENTS⁽¹⁾
(56-Ball GQL/ZQL Package)

	1	2	3	4	5	6
A	1 \overline{OE}	NC	NC	NC	NC	2 \overline{OE}
B	1Y2	1Y1	GND	GND	1A1	1A2
C	1Y4	1Y3	V _{CC}	V _{CC}	1A3	1A4
D	2Y2	2Y1	GND	GND	2A1	2A2
E	2Y4	2Y3			2A3	2A4
F	3Y1	3Y2			3A2	3A1
G	3Y3	3Y4	GND	GND	3A4	3A3
H	4Y1	4Y2	V _{CC}	V _{CC}	4A2	4A1
J	4Y3	4Y4	GND	GND	4A4	4A3
K	4 \overline{OE}	NC	NC	NC	NC	3 \overline{OE}

(1) NC – No internal connection

GRD OR ZRD PACKAGE
(TOP VIEW)

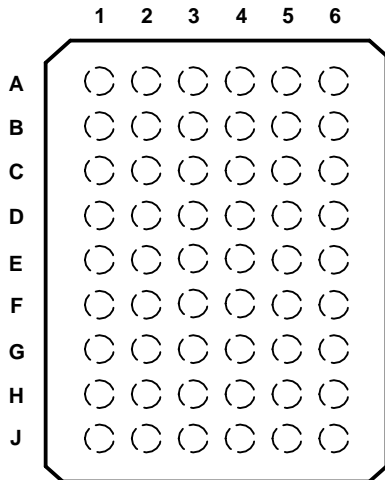

TERMINAL ASSIGNMENTS⁽¹⁾
(54-Ball GRD/ZRD Package)

	1	2	3	4	5	6
A	1Y1	NC	1 \overline{OE}	2 \overline{OE}	NC	1A1
B	1Y3	1Y2	NC	NC	1A2	1A3
C	2Y1	1Y4	V _{CC}	V _{CC}	1A4	2A1
D	2Y3	2Y2	GND	GND	2A2	2A3
E	3Y1	2Y4	GND	GND	2A4	3A1
F	3Y3	3Y2	GND	GND	3A2	3A3
G	4Y1	3Y4	V _{CC}	V _{CC}	3A4	4A1
H	4Y3	4Y2	NC	NC	4A2	4A3
J	4Y4	NC	4 \overline{OE}	3 \overline{OE}	NC	4A4

(1) NC – No internal connection

FUNCTION TABLE
(EACH 4-BIT BUFFER)

INPUTS		OUTPUT Y
\overline{OE}	A	
L	H	H
L	L	L
H	X	Z

LOGIC DIAGRAM (POSITIVE LOGIC)

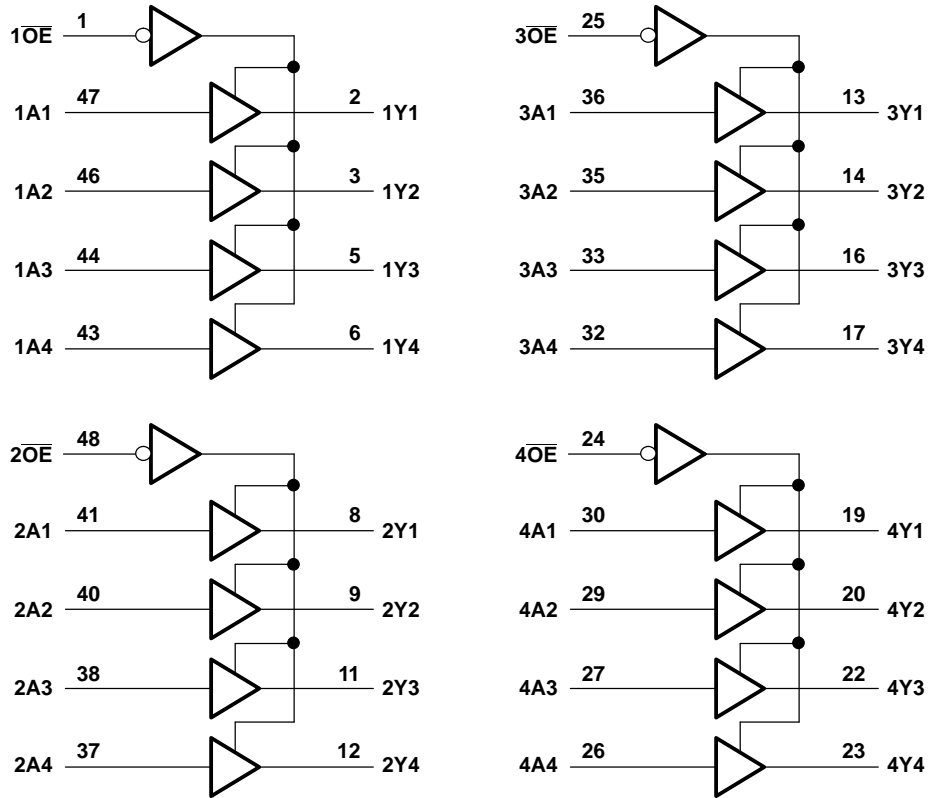

Pin numbers shown are for the DGG and DL packages.

Absolute Maximum Ratings⁽¹⁾

over operating free-air temperature range (unless otherwise noted)

		MIN	MAX	UNIT	
V_{CC}	Supply voltage range	-0.5	4.6	V	
V_I	Input voltage range ⁽²⁾	Control Inputs ⁽³⁾	-0.5	$V_{CC} + 0.5$	V
		Data Inputs	-0.5	4.6	
V_O	Output voltage range ⁽²⁾⁽³⁾	-0.5	$V_{CC} + 0.5$	V	
I_{IK}	Input clamp current		-50	mA	
I_{OK}	Output clamp current		-50	mA	
I_O	Continuous output current		±50	mA	
	Continuous current through each V_{CC} or GND		±100	mA	
θ_{JA}	Package thermal impedance ⁽⁴⁾	DGG package		70	°C/W
		DL package		63	
		GQL/ZQL package		42	
		GRD/ZRD package		36	
T_{stg}	Storage temperature range	-65	150	°C	

- (1) Stresses beyond those listed under "absolute maximum ratings" may cause permanent damage to the device. These are stress ratings only, and functional operation of the device at these or any other conditions beyond those indicated under "recommended operating conditions" is not implied. Exposure to absolute-maximum-rated conditions for extended periods may affect device reliability.
- (2) The input negative-voltage and output voltage ratings may be exceeded if the input and output current ratings are observed.
- (3) This value is limited to 4.6 V maximum.
- (4) The package thermal impedance is calculated in accordance with JESD 51-7.

SN74ALVC16244A
16-BIT BUFFER/DRIVER
WITH 3-STATE OUTPUTS

SCAS2500–JANUARY 1993–REVISED OCTOBER 2005

Recommended Operating Conditions⁽¹⁾

		MIN	MAX	UNIT
V _{CC}	Supply voltage	1.65	3.6	V
V _{IH}	High-level input voltage	V _{CC} = 1.65 V to 1.95 V	0.65 × V _{CC}	V
		V _{CC} = 2.3 V to 2.7 V	1.7	
		V _{CC} = 2.7 V to 3.6 V	2	
V _{IL}	Low-level input voltage	V _{CC} = 1.65 V to 1.95 V	0.35 × V _{CC}	V
		V _{CC} = 2.3 V to 2.7 V	0.7	
		V _{CC} = 2.7 V to 3.6 V	0.8	
V _I	Input voltage	Control Inputs	0	V _{CC}
		Data Inputs	0	3.6
V _O	Output voltage	0	V _{CC}	V
I _{OH}	High-level output current	V _{CC} = 1.65 V	–4	mA
		V _{CC} = 2.3 V	–12	
		V _{CC} = 2.7 V	–12	
		V _{CC} = 3 V	–24	
I _{OL}	Low-level output current	V _{CC} = 1.65 V	4	mA
		V _{CC} = 2.3 V	12	
		V _{CC} = 2.7 V	12	
		V _{CC} = 3 V	24	
Δt/Δv	Input transition rise or fall rate		10	ns/V
T _A	Operating free-air temperature	–40	85	°C

(1) All unused inputs of the device must be held at V_{CC} or GND to ensure proper device operation. Refer to the TI application report, *Implications of Slow or Floating CMOS Inputs*, literature number SCBA004.

Electrical Characteristics

over recommended operating free-air temperature range (unless otherwise noted)

PARAMETER	TEST CONDITIONS	V _{CC}	MIN	TYP ⁽¹⁾	MAX	UNIT
V _{OH}	I _{OH} = –100 μA	1.65 V to 3.6 V	V _{CC} – 0.2		V	
	I _{OH} = –4 mA	1.65 V	1.2			
	I _{OH} = –6 mA	2.3 V	2			
	I _{OH} = –12 mA	2.3 V	1.7			
		2.7 V	2.2			
	I _{OH} = –24 mA	3 V	2.4			
V _{OL}	I _{OL} = 100 μA	1.65 V to 3.6 V	0.2		V	
	I _{OL} = 4 mA	1.65 V	0.45			
	I _{OL} = 6 mA	2.3 V	0.4			
	I _{OL} = 12 mA	2.3 V	0.7			
		2.7 V	0.4			
	I _{OL} = 24 mA	3 V	0.55			
I _I	V _I = V _{CC} or GND	3.6 V	±5		μA	
I _{OZ}	V _O = V _{CC} or GND	3.6 V	±10		μA	
I _{CC}	V _I = V _{CC} or GND, I _O = 0	3.6 V	40		μA	
ΔI _{CC}	One input at V _{CC} – 0.6 V, Other inputs at V _{CC} or GND	3 V to 3.6 V	750		μA	
C _i	Control inputs	V _I = V _{CC} or GND	3		pF	
	Data inputs		6			

(1) All typical values are at V_{CC} = 3.3 V, T_A = 25°C.

Electrical Characteristics (continued)

over recommended operating free-air temperature range (unless otherwise noted)

PARAMETER		TEST CONDITIONS	V _{CC}	MIN	TYP ⁽¹⁾	MAX	UNIT
C _o	Outputs	V _O = V _{CC} or GND	3.3 V		7		pF

Switching Characteristics

over recommended operating free-air temperature range (unless otherwise noted) (see [Figure 1](#))

PARAMETER	FROM (INPUT)	TO (OUTPUT)	V _{CC} = 1.8 V	V _{CC} = 2.5 V ± 0.2 V		V _{CC} = 2.7 V		V _{CC} = 3.3 V ± 0.3 V		UNIT
			TYP	MIN	MAX	MIN	MAX	MIN	MAX	
t _{pd}	A	Y	(1)	1	3.7	3.6		1	3	ns
t _{en}	\overline{OE}	Y	(1)	1	5.7	5.4		1	4.4	ns
t _{dis}	\overline{OE}	Y	(1)	1	5.2	4.6		1	4.1	ns

(1) This information was not available at the time of publication.

Operating Characteristics

T_A = 25°C

PARAMETER		TEST CONDITIONS	V _{CC} = 1.8 V	V _{CC} = 2.5 V	V _{CC} = 3.3 V	UNIT
			TYP	TYP	TYP	
C _{pd}	Power dissipation	C _L = 50 pF, f = 10 MHz	(1)	16	19	pF
	capacitance		(1)	4	5	

(1) This information was not available at the time of publication.

PARAMETER MEASUREMENT INFORMATION

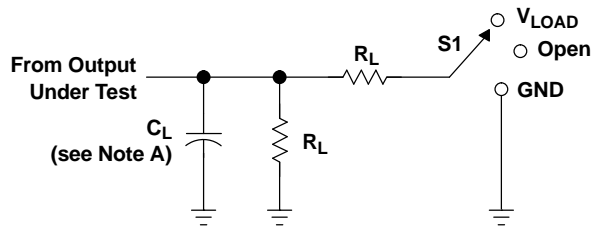

TEST	S1
t_{pd}	Open
t_{PLZ}/t_{PZH}	V_{LOAD}
t_{PHZ}/t_{PHZ}	GND

LOAD CIRCUIT

V_{CC}	INPUT		V_M	V_{LOAD}	C_L	R_L	V_{Δ}
	V_I	t_r/t_f					
1.8 V	V_{CC}	≤ 2 ns	$V_{CC}/2$	$2 \times V_{CC}$	30 pF	1 k Ω	0.15 V
$2.5 V \pm 0.2 V$	V_{CC}	≤ 2 ns	$V_{CC}/2$	$2 \times V_{CC}$	30 pF	500 Ω	0.15 V
2.7 V	2.7 V	≤ 2.5 ns	1.5 V	6 V	50 pF	500 Ω	0.3 V
$3.3 V \pm 0.3 V$	2.7 V	≤ 2.5 ns	1.5 V	6 V	50 pF	500 Ω	0.3 V

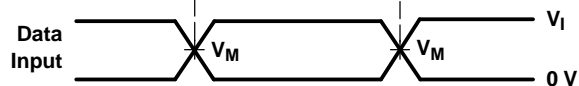
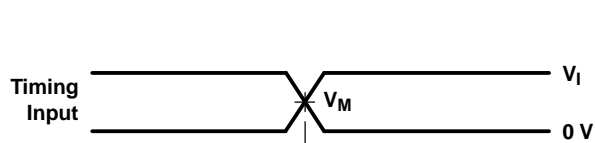

VOLTAGE WAVEFORMS
SETUP AND HOLD TIMES

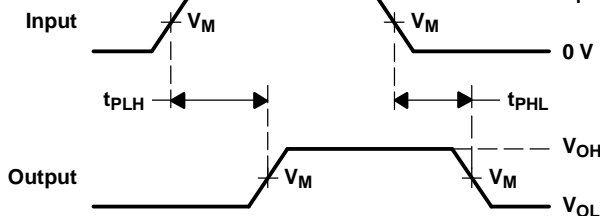

VOLTAGE WAVEFORMS
PROPAGATION DELAY TIMES

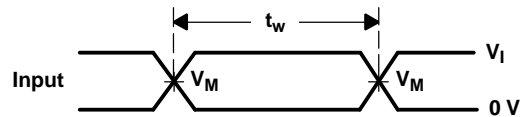

VOLTAGE WAVEFORMS
PULSE DURATION

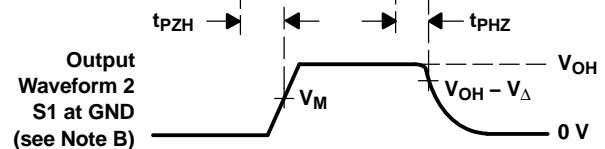
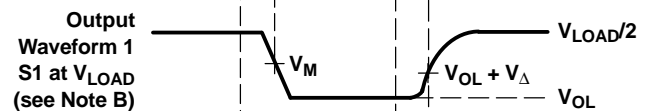

VOLTAGE WAVEFORMS
ENABLE AND DISABLE TIMES

- NOTES: A. C_L includes probe and jig capacitance.
 B. Waveform 1 is for an output with internal conditions such that the output is low, except when disabled by the output control. Waveform 2 is for an output with internal conditions such that the output is high, except when disabled by the output control.
 C. All input pulses are supplied by generators having the following characteristics: $PRR \leq 10$ MHz, $Z_O = 50 \Omega$.
 D. The outputs are measured one at a time, with one transition per measurement.
 E. t_{PLZ} and t_{PHZ} are the same as t_{dis} .
 F. t_{PZL} and t_{PZH} are the same as t_{en} .
 G. t_{PLH} and t_{PHL} are the same as t_{pd} .
 H. All parameters and waveforms are not applicable to all devices.

Figure 1. Load Circuit and Voltage Waveforms

PACKAGING INFORMATION

Orderable Device	Status (1)	Package Type	Package Drawing	Pins	Package Qty	Eco Plan (2)	Lead/Ball Finish	MSL Peak Temp (3)	Op Temp (°C)	Top-Side Markings (4)	Samples
74ALVC16244ADGGRE4	ACTIVE	TSSOP	DGG	48	2000	Green (RoHS & no Sb/Br)	CU NIPDAU	Level-1-260C-UNLIM	-40 to 85	ALVC16244A	Samples
74ALVC16244ADGGRG4	ACTIVE	TSSOP	DGG	48	2000	Green (RoHS & no Sb/Br)	CU NIPDAU	Level-1-260C-UNLIM	-40 to 85	ALVC16244A	Samples
74ALVC16244ADLRG4	ACTIVE	SSOP	DL	48	1000	Green (RoHS & no Sb/Br)	CU NIPDAU	Level-1-260C-UNLIM	-40 to 85	ALVC16244A	Samples
SN74ALVC16244ADGGR	ACTIVE	TSSOP	DGG	48	2000	Green (RoHS & no Sb/Br)	CU NIPDAU	Level-1-260C-UNLIM	-40 to 85	ALVC16244A	Samples
SN74ALVC16244ADGGRE4	ACTIVE	TSSOP	DGG	48		TBD	Call TI	Call TI	-40 to 85		Samples
SN74ALVC16244ADL	ACTIVE	SSOP	DL	48	25	Green (RoHS & no Sb/Br)	CU NIPDAU	Level-1-260C-UNLIM	-40 to 85	ALVC16244A	Samples
SN74ALVC16244ADLG4	ACTIVE	SSOP	DL	48	25	Green (RoHS & no Sb/Br)	CU NIPDAU	Level-1-260C-UNLIM	-40 to 85	ALVC16244A	Samples
SN74ALVC16244ADLR	ACTIVE	SSOP	DL	48	1000	Green (RoHS & no Sb/Br)	CU NIPDAU	Level-1-260C-UNLIM	-40 to 85	ALVC16244A	Samples
SN74ALVC16244AGQLR	OBSOLETE	BGA MICROSTAR JUNIOR	GQL	56		TBD	Call TI	Call TI	-40 to 85	VC244A	
SN74ALVC16244AGRDR	OBSOLETE	BGA MICROSTAR JUNIOR	GRD	54		TBD	Call TI	Call TI	-40 to 85	VC244A	
SN74ALVC16244AZQLR	ACTIVE	BGA MICROSTAR JUNIOR	ZQL	56	1000	Green (RoHS & no Sb/Br)	SNAGCU	Level-1-260C-UNLIM	-40 to 85	VC244A	Samples

(1) The marketing status values are defined as follows:

ACTIVE: Product device recommended for new designs.

LIFEBUY: TI has announced that the device will be discontinued, and a lifetime-buy period is in effect.

NRND: Not recommended for new designs. Device is in production to support existing customers, but TI does not recommend using this part in a new design.

PREVIEW: Device has been announced but is not in production. Samples may or may not be available.

OBSOLETE: TI has discontinued the production of the device.

(2) Eco Plan - The planned eco-friendly classification: Pb-Free (RoHS), Pb-Free (RoHS Exempt), or Green (RoHS & no Sb/Br) - please check <http://www.ti.com/productcontent> for the latest availability information and additional product content details.

TBD: The Pb-Free/Green conversion plan has not been defined.

Pb-Free (RoHS): TI's terms "Lead-Free" or "Pb-Free" mean semiconductor products that are compatible with the current RoHS requirements for all 6 substances, including the requirement that lead not exceed 0.1% by weight in homogeneous materials. Where designed to be soldered at high temperatures, TI Pb-Free products are suitable for use in specified lead-free processes.

Pb-Free (RoHS Exempt): This component has a RoHS exemption for either 1) lead-based flip-chip solder bumps used between the die and package, or 2) lead-based die adhesive used between the die and leadframe. The component is otherwise considered Pb-Free (RoHS compatible) as defined above.

Green (RoHS & no Sb/Br): TI defines "Green" to mean Pb-Free (RoHS compatible), and free of Bromine (Br) and Antimony (Sb) based flame retardants (Br or Sb do not exceed 0.1% by weight in homogeneous material)

⁽³⁾ MSL, Peak Temp. -- The Moisture Sensitivity Level rating according to the JEDEC industry standard classifications, and peak solder temperature.

⁽⁴⁾ Multiple Top-Side Markings will be inside parentheses. Only one Top-Side Marking contained in parentheses and separated by a "~" will appear on a device. If a line is indented then it is a continuation of the previous line and the two combined represent the entire Top-Side Marking for that device.

Important Information and Disclaimer: The information provided on this page represents TI's knowledge and belief as of the date that it is provided. TI bases its knowledge and belief on information provided by third parties, and makes no representation or warranty as to the accuracy of such information. Efforts are underway to better integrate information from third parties. TI has taken and continues to take reasonable steps to provide representative and accurate information but may not have conducted destructive testing or chemical analysis on incoming materials and chemicals. TI and TI suppliers consider certain information to be proprietary, and thus CAS numbers and other limited information may not be available for release.

In no event shall TI's liability arising out of such information exceed the total purchase price of the TI part(s) at issue in this document sold by TI to Customer on an annual basis.

TAPE AND REEL INFORMATION

QUADRANT ASSIGNMENTS FOR PIN 1 ORIENTATION IN TAPE

*All dimensions are nominal

Device	Package Type	Package Drawing	Pins	SPQ	Reel Diameter (mm)	Reel Width W1 (mm)	A0 (mm)	B0 (mm)	K0 (mm)	P1 (mm)	W (mm)	Pin1 Quadrant
SN74ALVC16244ADGGR	TSSOP	DGG	48	2000	330.0	24.4	8.6	15.8	1.8	12.0	24.0	Q1
SN74ALVC16244ADLR	SSOP	DL	48	1000	330.0	32.4	11.35	16.2	3.1	16.0	32.0	Q1
SN74ALVC16244AZQLR	BGA MICROSTAR JUNIOR	ZQL	56	1000	330.0	16.4	4.8	7.3	1.5	8.0	16.0	Q1

TAPE AND REEL BOX DIMENSIONS

*All dimensions are nominal

Device	Package Type	Package Drawing	Pins	SPQ	Length (mm)	Width (mm)	Height (mm)
SN74ALVC16244ADGGR	TSSOP	DGG	48	2000	367.0	367.0	45.0
SN74ALVC16244ADLR	SSOP	DL	48	1000	367.0	367.0	55.0
SN74ALVC16244AZQLR	BGA MICROSTAR JUNIOR	ZQL	56	1000	336.6	336.6	28.6

ZQL (R-PBGA-N56)

PLASTIC BALL GRID ARRAY

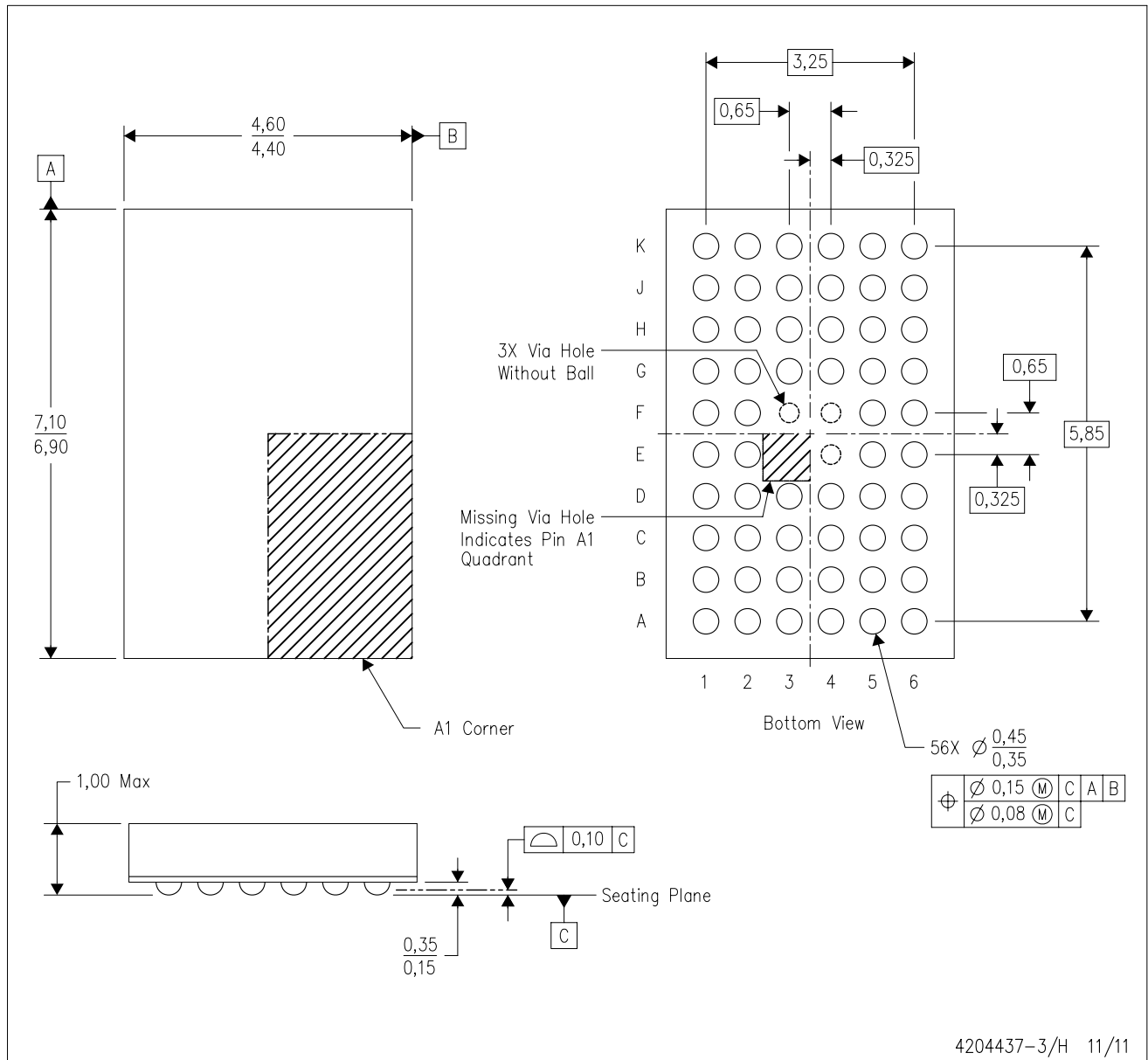

- NOTES:
- A. All linear dimensions are in millimeters. Dimensioning and tolerancing per ASME Y14.5M-1994.
 - B. This drawing is subject to change without notice.
 - C. Falls within JEDEC MO-285 variation BA-2.
 - D. This package is Pb-free. Refer to the 56 GQL package (drawing 4200583) for tin-lead (SnPb).

GRD (R-PBGA-N54)

PLASTIC BALL GRID ARRAY

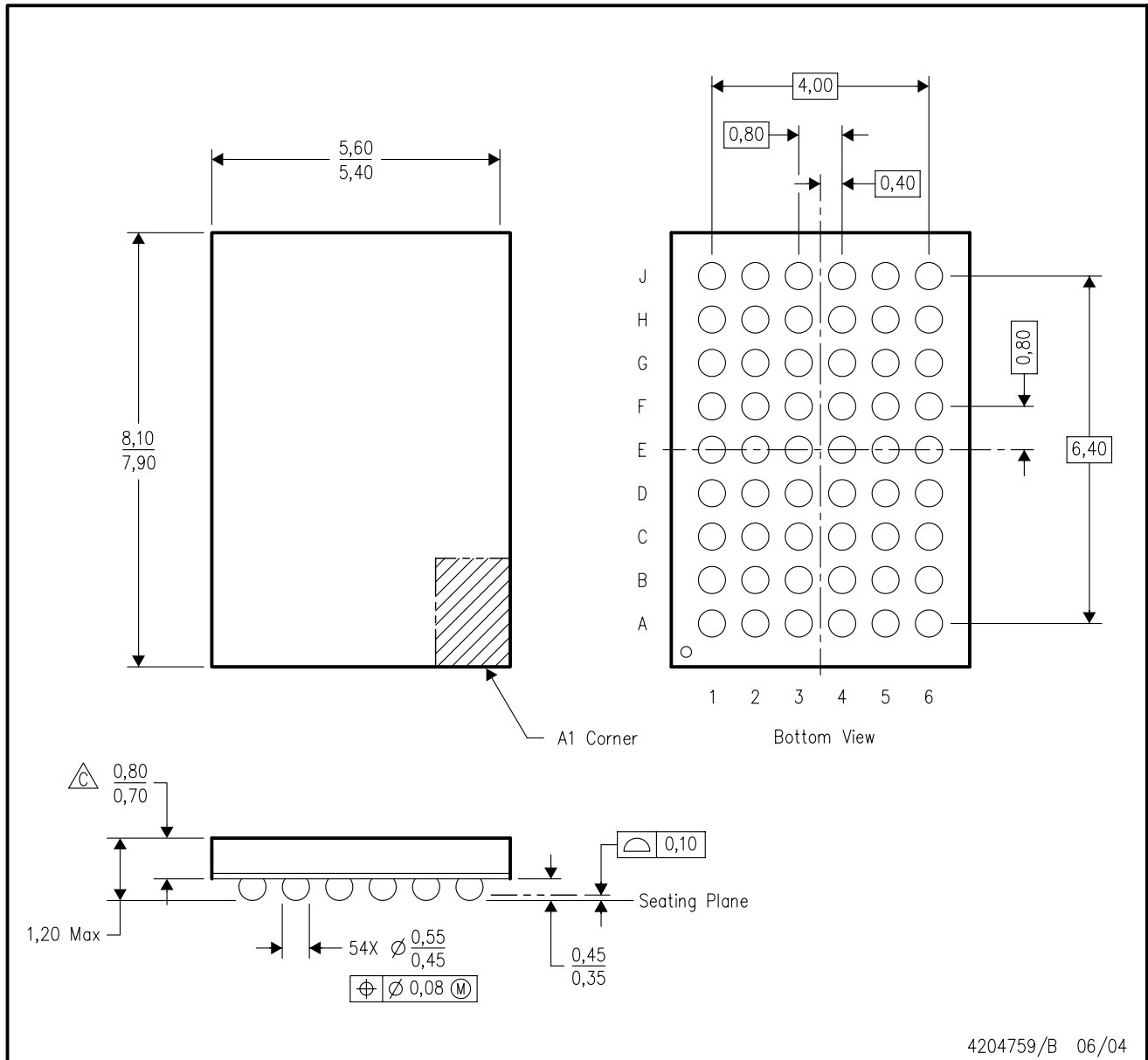

- NOTES:
- A. All linear dimensions are in millimeters.
 - B. This drawing is subject to change without notice.
 - C Falls within JEDEC MO-205 variation DD.
 - D. This package is tin-lead (SnPb). Refer to the 54 ZRD package (drawing 4204760) for lead-free.

MECHANICAL DATA

DL (R-PDSO-G48)

PLASTIC SMALL-OUTLINE PACKAGE

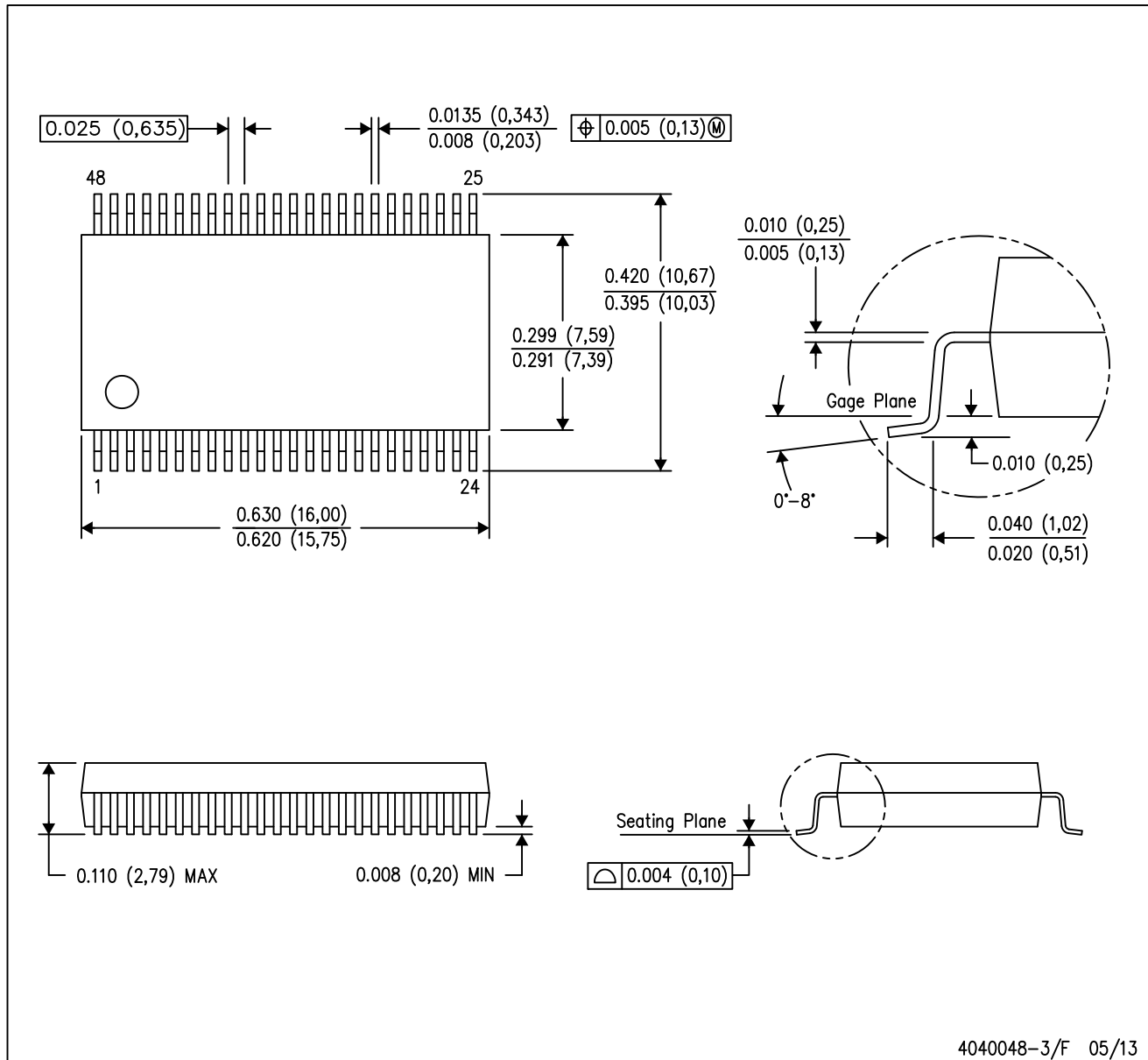

- NOTES:
- A. All linear dimensions are in inches (millimeters).
 - B. This drawing is subject to change without notice.
 - C. Body dimensions do not include mold flash or protrusion not to exceed 0.006 (0,15).
 - D. Falls within JEDEC MO-118

PowerPAD is a trademark of Texas Instruments.

GQL (R-PBGA-N56)

PLASTIC BALL GRID ARRAY

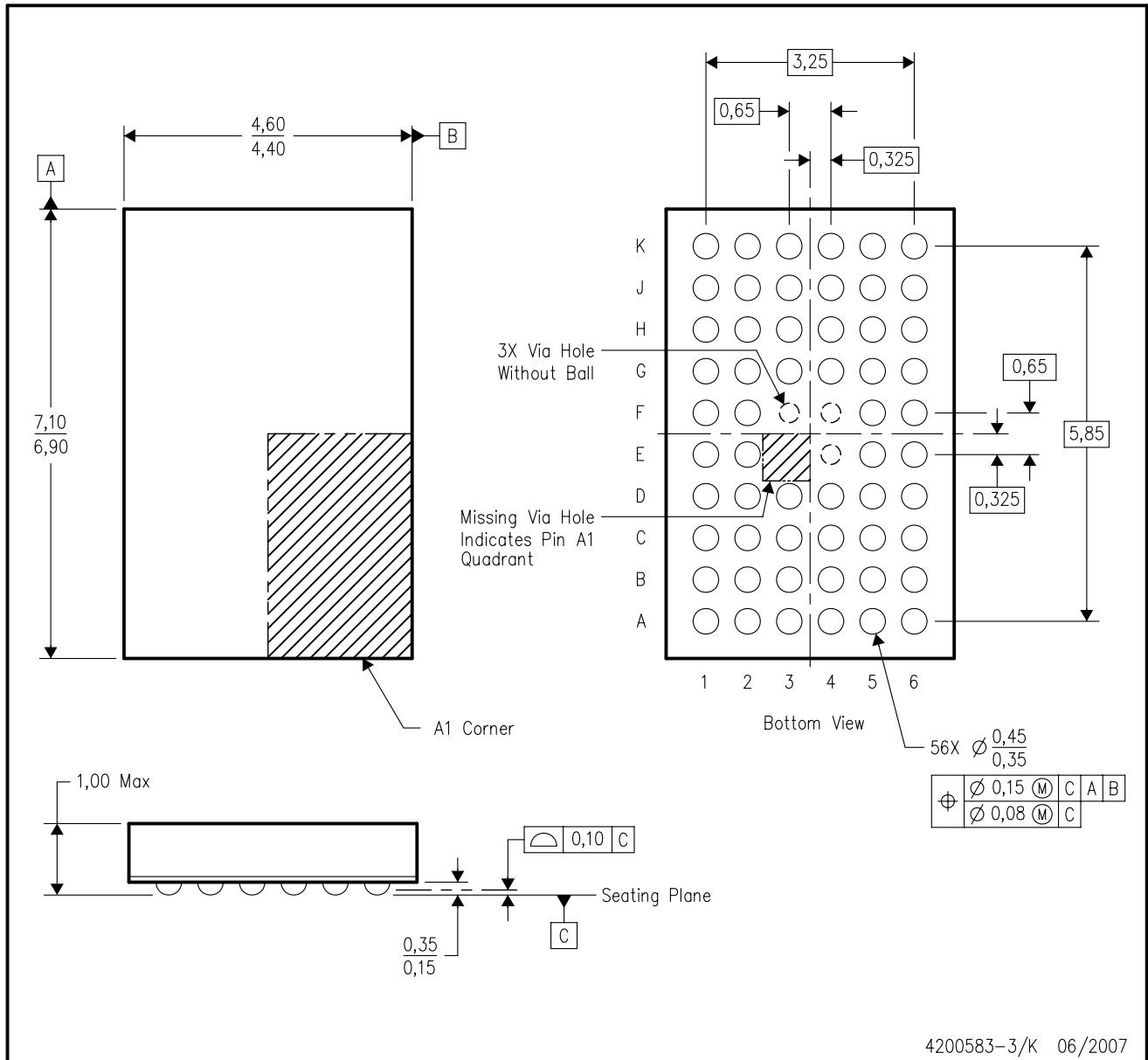

- NOTES:
- A. All linear dimensions are in millimeters. Dimensioning and tolerancing per ASME Y14.5M-1994.
 - B. This drawing is subject to change without notice.
 - C. Falls within JEDEC MO-285 variation BA-2.
 - D. This package is tin-lead (SnPb). Refer to the 56 ZQL package (drawing 4204437) for lead-free.

DGG (R-PDSO-G**)

PLASTIC SMALL-OUTLINE PACKAGE

48 PINS SHOWN



- NOTES: A. All linear dimensions are in millimeters.
 B. This drawing is subject to change without notice.
 C. Body dimensions do not include mold protrusion not to exceed 0,15.
 D. Falls within JEDEC MO-153

IMPORTANT NOTICE

Texas Instruments Incorporated and its subsidiaries (TI) reserve the right to make corrections, enhancements, improvements and other changes to its semiconductor products and services per JESD46, latest issue, and to discontinue any product or service per JESD48, latest issue. Buyers should obtain the latest relevant information before placing orders and should verify that such information is current and complete. All semiconductor products (also referred to herein as "components") are sold subject to TI's terms and conditions of sale supplied at the time of order acknowledgment.

TI warrants performance of its components to the specifications applicable at the time of sale, in accordance with the warranty in TI's terms and conditions of sale of semiconductor products. Testing and other quality control techniques are used to the extent TI deems necessary to support this warranty. Except where mandated by applicable law, testing of all parameters of each component is not necessarily performed.

TI assumes no liability for applications assistance or the design of Buyers' products. Buyers are responsible for their products and applications using TI components. To minimize the risks associated with Buyers' products and applications, Buyers should provide adequate design and operating safeguards.

TI does not warrant or represent that any license, either express or implied, is granted under any patent right, copyright, mask work right, or other intellectual property right relating to any combination, machine, or process in which TI components or services are used. Information published by TI regarding third-party products or services does not constitute a license to use such products or services or a warranty or endorsement thereof. Use of such information may require a license from a third party under the patents or other intellectual property of the third party, or a license from TI under the patents or other intellectual property of TI.

Reproduction of significant portions of TI information in TI data books or data sheets is permissible only if reproduction is without alteration and is accompanied by all associated warranties, conditions, limitations, and notices. TI is not responsible or liable for such altered documentation. Information of third parties may be subject to additional restrictions.

Resale of TI components or services with statements different from or beyond the parameters stated by TI for that component or service voids all express and any implied warranties for the associated TI component or service and is an unfair and deceptive business practice. TI is not responsible or liable for any such statements.

Buyer acknowledges and agrees that it is solely responsible for compliance with all legal, regulatory and safety-related requirements concerning its products, and any use of TI components in its applications, notwithstanding any applications-related information or support that may be provided by TI. Buyer represents and agrees that it has all the necessary expertise to create and implement safeguards which anticipate dangerous consequences of failures, monitor failures and their consequences, lessen the likelihood of failures that might cause harm and take appropriate remedial actions. Buyer will fully indemnify TI and its representatives against any damages arising out of the use of any TI components in safety-critical applications.

In some cases, TI components may be promoted specifically to facilitate safety-related applications. With such components, TI's goal is to help enable customers to design and create their own end-product solutions that meet applicable functional safety standards and requirements. Nonetheless, such components are subject to these terms.

No TI components are authorized for use in FDA Class III (or similar life-critical medical equipment) unless authorized officers of the parties have executed a special agreement specifically governing such use.

Only those TI components which TI has specifically designated as military grade or "enhanced plastic" are designed and intended for use in military/aerospace applications or environments. Buyer acknowledges and agrees that any military or aerospace use of TI components which have **not** been so designated is solely at the Buyer's risk, and that Buyer is solely responsible for compliance with all legal and regulatory requirements in connection with such use.

TI has specifically designated certain components as meeting ISO/TS16949 requirements, mainly for automotive use. In any case of use of non-designated products, TI will not be responsible for any failure to meet ISO/TS16949.

Products

Audio	www.ti.com/audio
Amplifiers	amplifier.ti.com
Data Converters	dataconverter.ti.com
DLP® Products	www.dlp.com
DSP	dsp.ti.com
Clocks and Timers	www.ti.com/clocks
Interface	interface.ti.com
Logic	logic.ti.com
Power Mgmt	power.ti.com
Microcontrollers	microcontroller.ti.com
RFID	www.ti-rfid.com
OMAP Applications Processors	www.ti.com/omap
Wireless Connectivity	www.ti.com/wirelessconnectivity

Applications

Automotive and Transportation	www.ti.com/automotive
Communications and Telecom	www.ti.com/communications
Computers and Peripherals	www.ti.com/computers
Consumer Electronics	www.ti.com/consumer-apps
Energy and Lighting	www.ti.com/energy
Industrial	www.ti.com/industrial
Medical	www.ti.com/medical
Security	www.ti.com/security
Space, Avionics and Defense	www.ti.com/space-avionics-defense
Video and Imaging	www.ti.com/video

TI E2E Community

e2e.ti.com