

MSM51V257CLP**32,768-Word × 8-Bit CMOS STATIC RAM****DESCRIPTION**

The MSM51V257CLP is a 32,768-word by 8-bit CMOS static RAM featuring 3.0 V to 3.6 V power supply operation in the range of -40°C to 85°C and direct LVTTTL input/output compatibility. Since the circuitry is completely static, external clock and refreshing operations are unnecessary, making this device very easy to use. The MSM51V257CLP, which uses NMOS cells and CMOS peripherals, can be used in high-speed operation at 70 ns access time and in the low current consumption of a standby current max. $24\ \mu\text{A}$ when there is no chip selection. The MSM51V257CLP's ability to hold the memory contents at 2 V provides a battery back-up. Since the MSM51V257CLP is provided with the $\overline{\text{CS}}$ and $\overline{\text{OE}}$ signals, it can connect with outputs of other chips in a wired OR technique, which provides easy memory expansion and bus line control.

FEATURES

- 32,768-word × 8-bit configuration
- Power supply voltage: 3.0 V to 3.6 V
- Operating temperature range: $T_a = -40^{\circ}\text{C}$ to 85°C
- (Input/Output) LVTTTL compatible
- 3-state output
- Data retention available at power supply voltage 2 V
- Package options:

28-pin 600 mil plastic DIP	(DIP28-P-600-2.54)	(Product : MSM51V257CLP-xxRS)
28-pin 430 mil plastic SOP	(SOP28-P-430-1.27-K)	(Product : MSM51V257CLP-xxGS-K)

 xx indicates speed rank.

PRODUCT FAMILY

Family	Access Time (Max.)	Power Dissipation	
		Operating (Max.)	Standby (Max.)
MSM51V257CLP-70	70 ns	162 mW	86.4 μW
MSM51V257CLP-85	85 ns	144 mW	
MSM51V257CLP-10	100 ns	126 mW	

PIN CONFIGURATION (TOP VIEW)

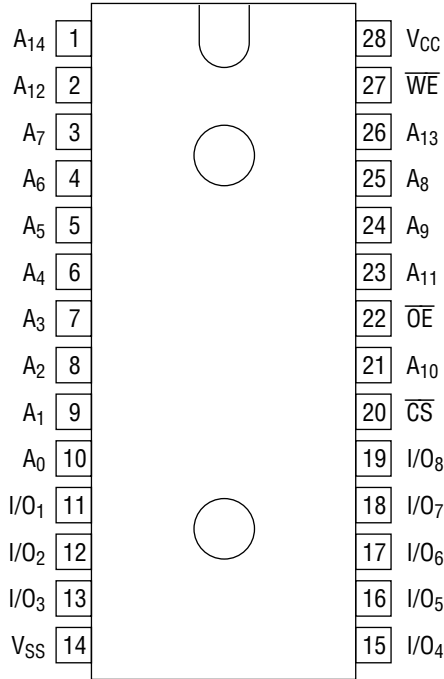

28-Pin Plastic DIP

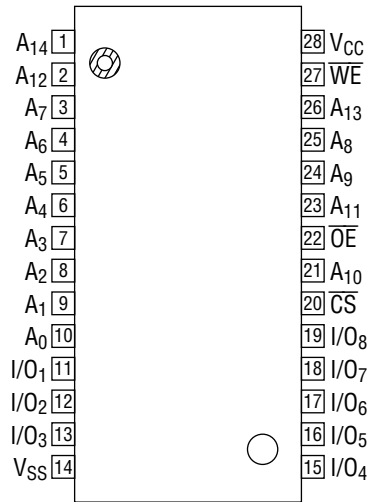

28-Pin Plastic SOP

Pin Name	Function
A ₀ - A ₁₄	Address Input
I/O ₁ - I/O ₈	Data Input/Output
\overline{CS}	Chip Select
\overline{WE}	Write Enable
\overline{OE}	Output Enable
V _{CC} , V _{SS}	Power Supply

BLOCK DIAGRAM

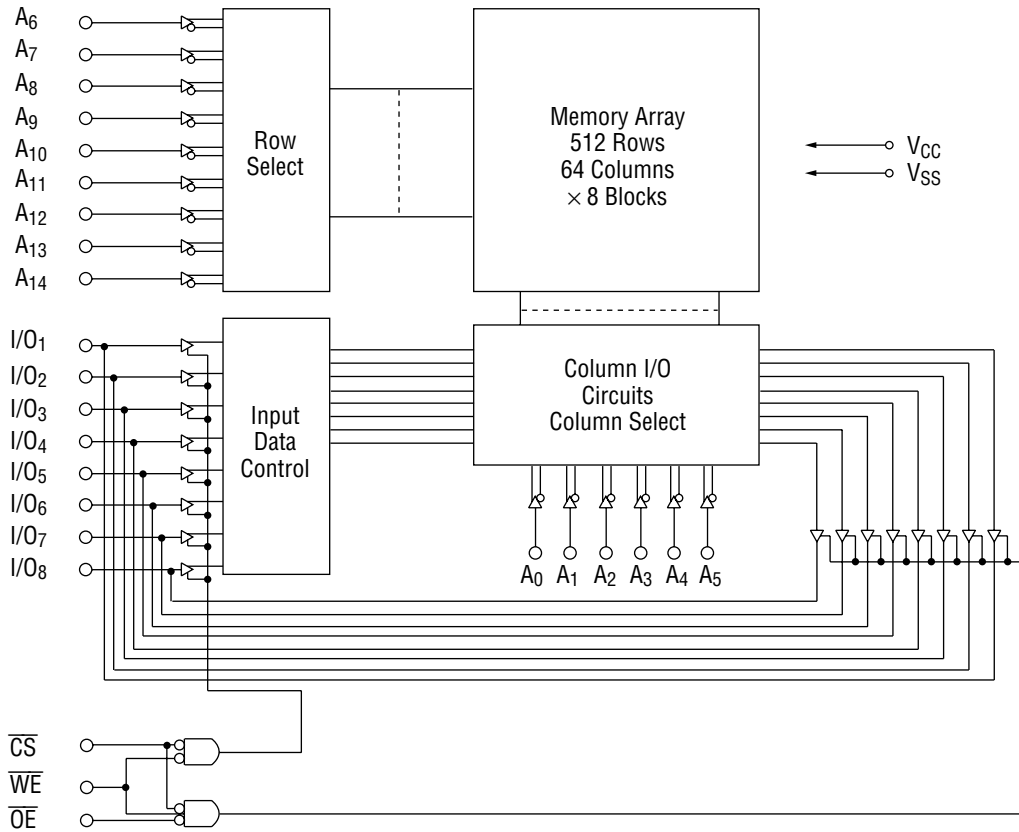

FUNCTION TABLE

Operating Mode	\overline{CS}	\overline{WE}	\overline{OE}	Operating Contents
Standby	H	*	*	Output Floating
Read Cycle	L	H	H	Output Floating
	L	H	L	Data Read
Write Cycle	L	L	*	Data Write

*Don't Care ("H" or "L")

ELECTRICAL CHARACTERISTICS

Absolute Maximum Ratings

Parameter	Symbol	Condition	Rating	Unit
Power Supply Voltage	V_{CC}	$T_a = 25^\circ\text{C}$, for V_{SS}	-0.5 to 4.6	V
Pin Voltage	V_T		-0.5* to $V_{CC} + 0.5$	V
Power Dissipation	P_D	$T_a = 25^\circ\text{C}$	1.0	W
Operating Temperature	T_{opr}	—	-40 to 85	$^\circ\text{C}$
Storage Temperature	T_{stg}	—	-55 to 150	$^\circ\text{C}$

* -1.2 V Min. for pulse width less than 30 ns.

Recommended Operating Conditions

Parameter	Symbol	Condition	Min.	Typ.	Max.	Unit
Power Supply Voltage	V_{CC}	—	3.0	—	3.6	V
	V_{SS}		0	0	0	V
Data Retention Voltage	V_{CCH}	—	2	—	3.6	V
Input High Voltage	V_{IH}	$V_{CC} = 3.0\text{ V to }3.6\text{ V}$	2.4	—	$V_{CC} + 0.3$	V
Input Low Voltage	V_{IL}		-0.3*	—	0.4	V
Load Capacitance	C_L	—	—	—	100	pF
Fan Out	N	LVTTL	—	—	1	—

* -1.2 V Min. for pulse width less than 30 ns.

Capacitance

($T_a = 25^\circ\text{C}$, $f = 1\text{ MHz}$)

Parameter	Symbol	Condition	Min.	Max.	Unit
Input Capacitance	C_I	$V_I = 0\text{ V}$	—	10	pF
Input/Output Capacitance	$C_{I/O}$	$V_{I/O} = 0\text{ V}$	—	10	pF

Note: This parameter is periodically sampled and not 100% tested.

DC Characteristics

($V_{CC} = 3.0\text{ V to }3.6\text{ V}$, $T_a = -40^\circ\text{C to }85^\circ\text{C}$)

Parameter	Symbol	Condition	MSM51V257CLP			Unit
			Min.	Typ.	Max.	
Input Leakage Current	I_{LI}	$V_I = 0\text{ to }V_{CC}$	-1	—	1	μA
Input/Output Leakage Current	I_{LO}	$\overline{CS} = V_{IH}$ or $\overline{OE} = V_{IH}$, $V_{I/O} = 0\text{ to }V_{CC}$	-1	—	1	μA
Output High Voltage	V_{OH}	$I_{OH} = -2.0\text{ mA}$	2.4	—	—	V
Output Low Voltage	V_{OL}	$I_{OL} = 2.0\text{ mA}$	—	—	0.4	V
Standby Power Supply Current	I_{CCS}	$\overline{CS} \geq V_{CC} - 0.2\text{ V}$, $V_I = 0\text{ to }V_{CC}$	—	—	30	μA
	I_{CCS1}	$\overline{CS} = V_{IH}$	—	—	0.6	mA
Operating Power Supply Current	I_{CCA}	Min. cycle, $I_{OUT} = 0\text{ mA}$	—	—	①	mA
		$f = 1\text{ MHz}$, $V_{IH} \geq V_{CC} - 0.2\text{ V}$, $V_{IL} \leq 0.2\text{ V}$, $I_{OUT} = 0\text{ mA}$	—	—	5	mA

① 51V257CL-70 45 mA
 51V257CL-85 40 mA
 51V257CL-10 35 mA

AC Characteristics

Test Conditions

Parameter	Condition
Input Pulse Level	$V_{IH} = 2.4\text{ V}$, $V_{IL} = 0.4\text{ V}$
Input Rise and Fall Times	5 ns
Input/Output Timing Level	1.4 V
Output Load	$C_L = 100\text{ pF}$, 1 LVTTTL Gate

Read Cycle

($V_{CC} = 3.0\text{ V to }3.6\text{ V}$, $T_a = -40^\circ\text{C to }85^\circ\text{C}$)

Parameter	Symbol	MSM51V257CL-70		MSM51V257CL-85		MSM51V257CL-10		Unit
		Min.	Max.	Min.	Max.	Min.	Max.	
Read Cycle Time	t_{RC}	70	—	85	—	100	—	ns
Address Access Time	t_{AA}	—	70	—	85	—	100	ns
\overline{CS} Access Time	t_{CO}	—	70	—	85	—	100	ns
\overline{OE} Access Time	t_{OE}	—	40	—	45	—	50	ns
\overline{CS} to Output in Low-Z	t_{CLZ}	5	—	5	—	5	—	ns
\overline{OE} to Output in Low-Z	t_{OLZ}	5	—	5	—	5	—	ns
Output Hold Time from Address Change	t_{OH}	10	—	10	—	10	—	ns
\overline{CS} to Output in High-Z	t_{CHZ}	—	30	—	30	—	35	ns
\overline{OE} to Output in High-Z	t_{OHZ}	—	30	—	30	—	35	ns

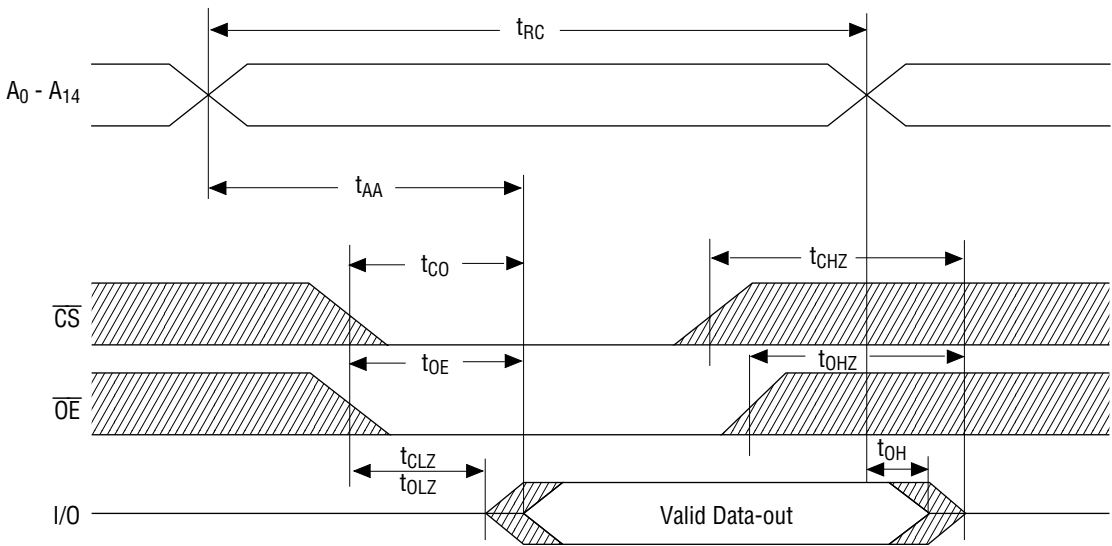

- Notes:
1. A read cycle occurs during the overlap of $\overline{CS} = "L"$, $\overline{OE} = "L"$ and $\overline{WE} = "H"$.
 2. t_{CHZ} and t_{OHZ} are specified by the time when DATA is floating, not defined by the output level.

Write Cycle

(V_{CC} = 3.0 V to 3.6 V, T_a = -40°C to 85°C)

Parameter	Symbol	MSM51V257CLP-70		MSM51V257CLP-85		MSM51V257CLP-10		Unit
		Min.	Max.	Min.	Max.	Min.	Max.	
Write Cycle Time	t _{WC}	70	—	85	—	100	—	ns
Address Setup Time	t _{AS}	0	—	0	—	0	—	ns
Write Pulse Width	t _{WP}	55	—	70	—	75	—	ns
Write Recovery Time	t _{WR}	5	—	5	—	5	—	ns
Data Setup Time	t _{DS}	35	—	40	—	40	—	ns
Data Hold Time	t _{DH}	0	—	0	—	0	—	ns
\overline{WE} to Output in High-Z	t _{WHZ}	—	30	—	30	—	35	ns
\overline{CS} to End of Write	t _{CW}	65	—	75	—	90	—	ns
Address Valid to End of Write	t _{AW}	65	—	75	—	90	—	ns
Output Active from End of Write	t _{WLZ}	5	—	5	—	5	—	ns

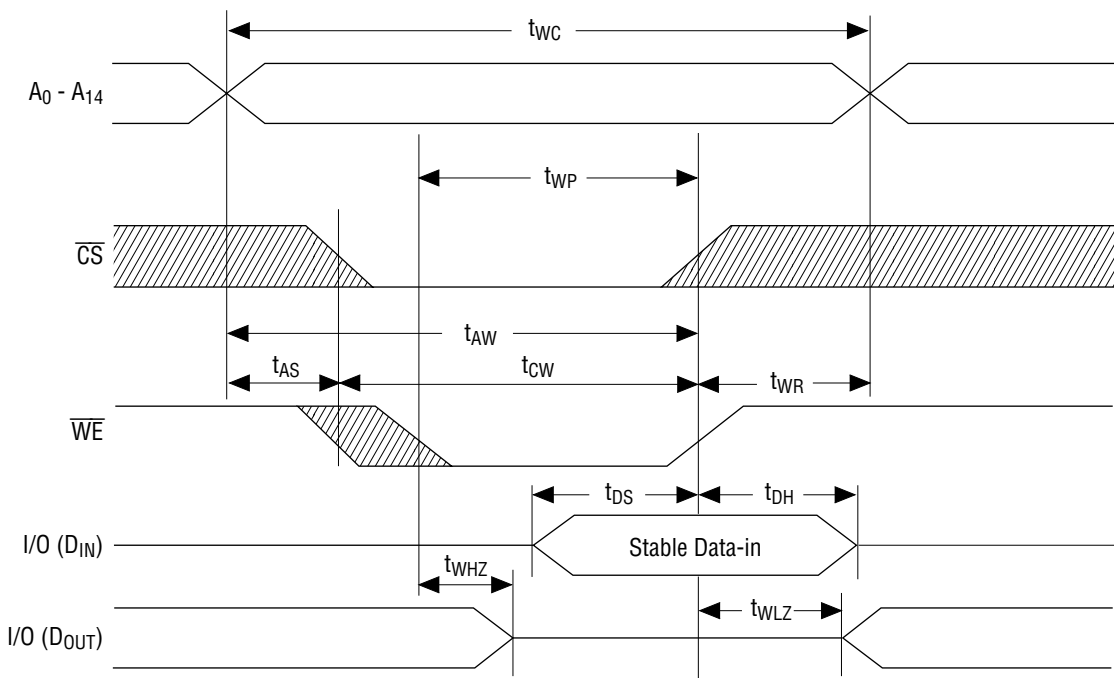

- Notes:
1. A write cycle occurs during the overlap of $\overline{CS} = "L"$ and $\overline{WE} = "L"$.
 2. \overline{OE} may be either of "H" or "L" in the write cycle.
 3. t_{AS} is specified from $\overline{CS} = "L"$ or $\overline{WE} = "L"$, whichever occurs last.
 4. t_{WP} is an overlap time of $\overline{CS} = "L"$ and $\overline{WE} = "L"$.
 5. t_{WR}, t_{DS} and t_{DH} are specified from $\overline{CS} = "H"$ or $\overline{WE} = "H"$, whichever occurs first.
 6. t_{WHZ} is specified by the time when DATA output is floating, not defined by the output level.
 7. When I/O pins are in the output mode, don't apply the inverted input signal to the output pins.

Data Retention Characteristics

(Ta = 0°C to 70°C)

Parameter	Symbol	Condition	Min.	Typ.	Max.	Unit
Data Retention Power Supply Voltage	V _{CCH}	$\overline{CS} \geq V_{CC} - 0.2 \text{ V}$	2.0	—	3.6	V
Data Retention Power Supply Current	I _{CCH}	V _{CC} = 3 V, $\overline{CS} \geq V_{CC} - 0.2 \text{ V}$	—	—	25*	μA
Chip Deselect to Data Retention Time	t _{CDR}	—	0	—	—	ns
Operation Recovery Time	t _R	—	50	—	—	ms

* 4 μA Max. when Ta = 0°C to 40°C.

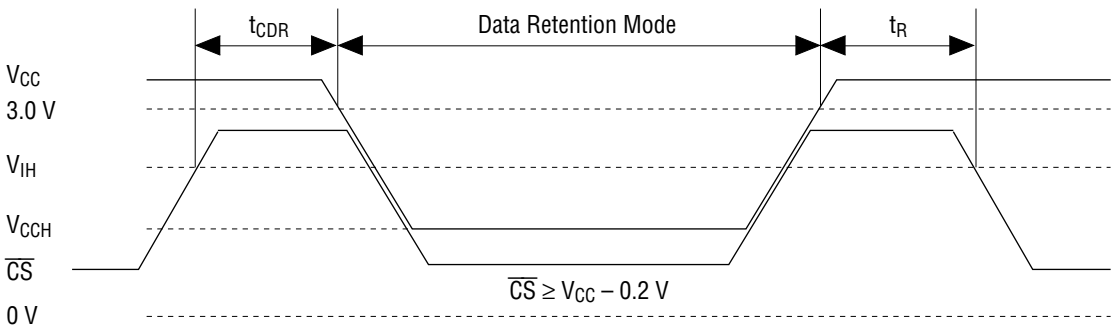

PACKAGE DIMENSIONS

(Unit : mm)

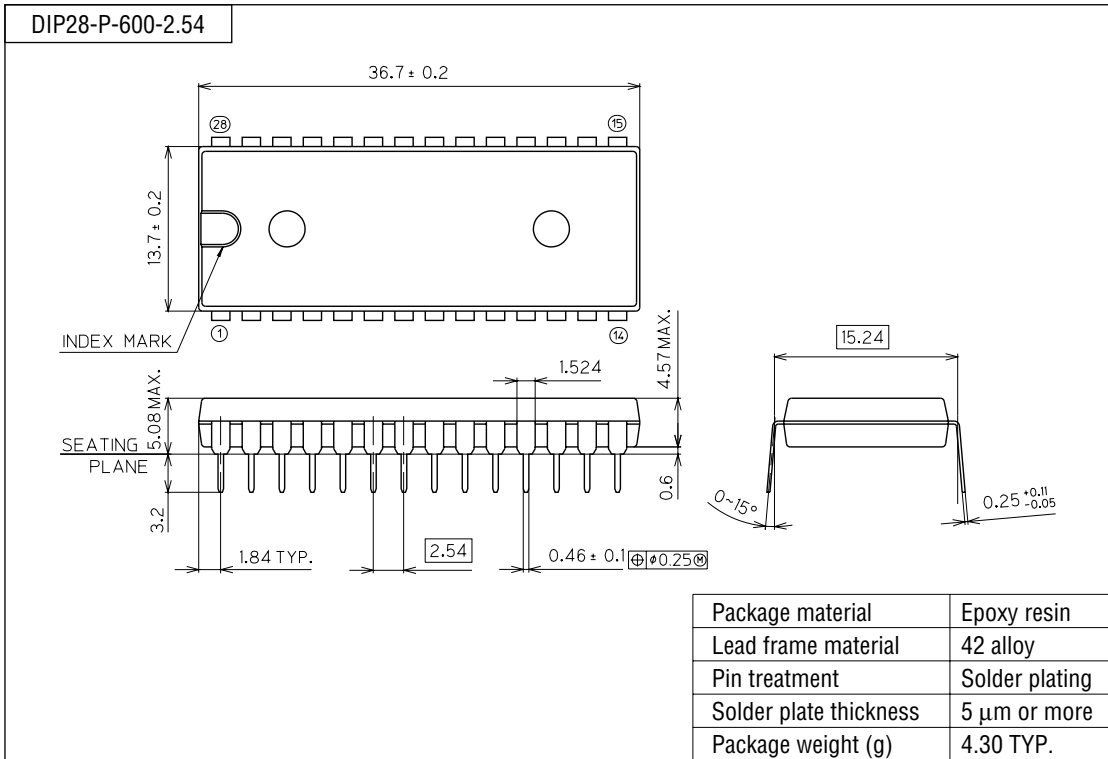

(Unit : mm)

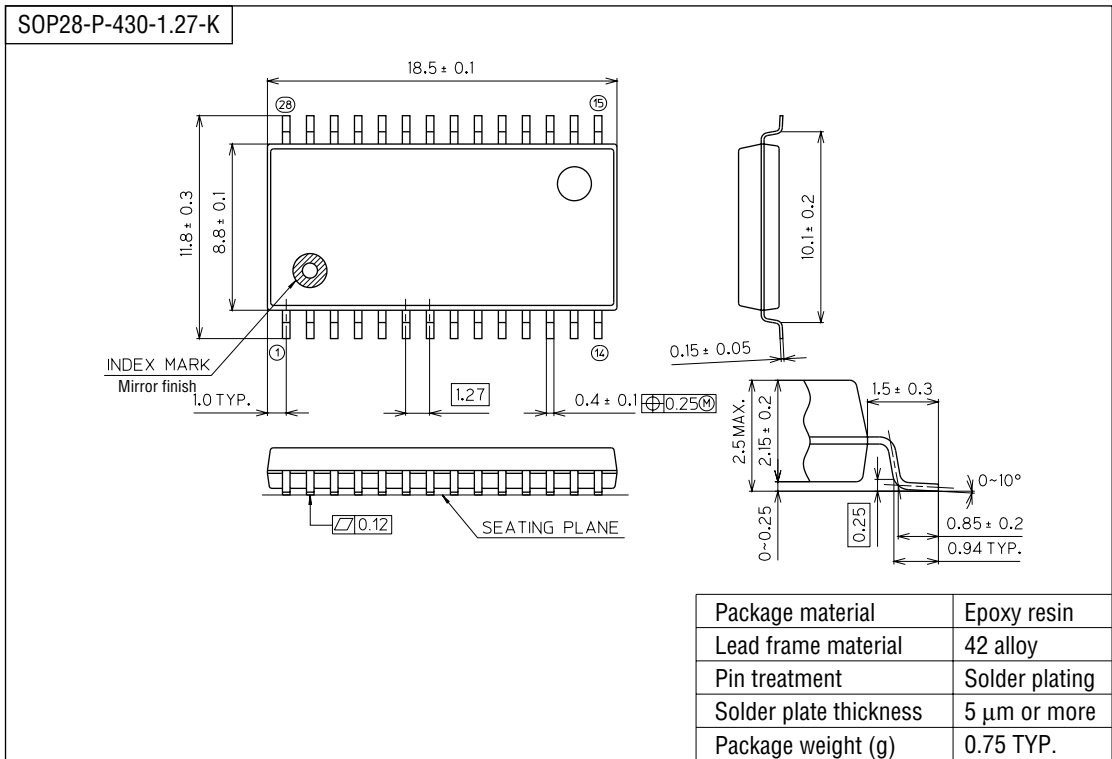

Notes for Mounting the Surface Mount Type Package

The SOP, QFP, TSOP, SOJ, QFJ (PLCC), SHP and BGA are surface mount type packages, which are very susceptible to heat in reflow mounting and humidity absorbed in storage. Therefore, before you perform reflow mounting, contact Oki's responsible sales person for the product name, package name, pin number, package code and desired mounting conditions (reflow method, temperature and times).