

LOW SKEW, 1-TO-4 LVCMOS/LVTTL FANOUT BUFFER

ICS8304I

GENERAL DESCRIPTION

The ICS8304I is a low skew, 1-to-4 Fanout Buffer. The ICS8304I is characterized at full 3.3V for input V_{DD} , and mixed 3.3V and 2.5V for output operating supply modes (V_{DDO}). Guaranteed output and part-to-part skew characteristics make the ICS8304I ideal for those clock distribution applications demanding well defined performance and repeatability.

FEATURES

- Four LVCMOS / LVTTL outputs
- LVCMOS clock input
- CLK can accept the following input levels: LVCMOS, LVTTL
- Maximum output frequency: 166MHz
- Output skew: 60ps (maximum)
- Part-to-part skew: 650ps (maximum)
- Small 8 lead SOIC package saves board space
- 3.3V input, outputs may be either 3.3V or 2.5V supply modes
- -40°C to 85°C ambient operating temperature
- Available in both standard (RoHS 5) and lead-free (RoHS 6) compliant packages

BLOCK DIAGRAM

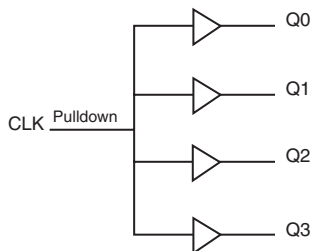

PIN ASSIGNMENT

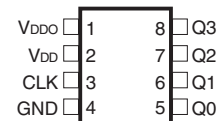

ICS8304I
8-Lead SOIC

3.8mm x 4.8mm, x 1.47mm package body

M Package
Top View

TABLE 1. PIN DESCRIPTIONS

Number	Name	Type		Description
1	V _{DDO}	Power		Output supply pin. Connect to 3.3V or 2.5V.
2	V _{DD}	Power		Positive supply pin. Connect to 3.3V.
3	CLK	Input	Pulldown	LVCMOS / LVTTL clock input.
4	GND	Power		Power supply ground. Connect to ground.
5	Q0	Output		Single clock output. LVCMOS / LVTTL interface levels.
6	Q1	Output		Single clock output. LVCMOS / LVTTL interface levels.
7	Q2	Output		Single clock output. LVCMOS / LVTTL interface levels.
8	Q3	Output		Single clock output. LVCMOS / LVTTL interface levels.

NOTE: *Pulldown* refer to internal input resistors. See Table 2, Pin Characteristics, for typical values.

TABLE 2. PIN CHARACTERISTICS

Symbol	Parameter	Test Conditions	Minimum	Typical	Maximum	Units
C _{IN}	Input Capacitance				4	pF
C _{PD}	Power Dissipation Capacitance (per output)	V _{DD} , V _{DDO} = 3.465V			15	pF
R _{PULLDOWN}	Input Pulldown Resistor			51		kΩ
R _{OUT}	Output Impedance			7		Ω

ABSOLUTE MAXIMUM RATINGS

Supply Voltage, V_{DD}	4.6V
Inputs, V_I	-0.5V to $V_{DD} + 0.5V$
Outputs, V_O	-0.5V to $V_{DDO} + 0.5V$
Package Thermal Impedance, θ_{JA}	112.7°C/W (0 lfpm)
Storage Temperature, T_{STG}	-65°C to 150°C

NOTE: Stresses beyond those listed under Absolute Maximum Ratings may cause permanent damage to the device. These ratings are stress specifications only. Functional operation of product at these conditions or any conditions beyond those listed in the *DC Characteristics* or *AC Characteristics* is not implied. Exposure to absolute maximum rating conditions for extended periods may affect product reliability.

TABLE 3A. POWER SUPPLY DC CHARACTERISTICS, $V_{DD} = V_{DDO} = 3.3V \pm 5\%$, $T_A = -40^\circ\text{C}$ TO 85°C

Symbol	Parameter	Test Conditions	Minimum	Typical	Maximum	Units
V_{DD}	Power Supply Voltage		3.135	3.3	3.465	V
V_{DDO}	Output Power Supply Voltage		3.135	3.3	3.465	V
I_{DD}	Power Supply Current				18	mA
I_{DDO}	Output Supply Current				11	mA

TABLE 3B. POWER SUPPLY DC CHARACTERISTICS, $V_{DD} = 3.3V \pm 5\%$, $V_{DDO} = 2.5V \pm 5\%$, $T_A = -40^\circ\text{C}$ TO 85°C

Symbol	Parameter	Test Conditions	Minimum	Typical	Maximum	Units
V_{DD}	Positive Supply Voltage		3.135	3.3	3.465	V
V_{DDO}	Output Supply Voltage		2.375	2.5	2.625	V
I_{DD}	Power Supply Current				18	mA
I_{DDO}	Output Supply Current				11	mA

TABLE 3C. LVCMOS / LVTTL DC CHARACTERISTICS, $V_{DD} = V_{DDO} = 3.3V \pm 5\%$, $T_A = -40^\circ\text{C}$ TO 85°C

Symbol	Parameter	Test Conditions	Minimum	Typical	Maximum	Units
V_{IH}	Input High Voltage		2		$V_{DD} + 0.3$	V
V_{IL}	Input Low Voltage		-0.3		1.3	V
I_{IH}	Input High Current	$V_{DD} = V_{IN} = 3.465V$			150	μA
I_{IL}	Input Low Current	$V_{DD} = 3.465V, V_{IN} = 0V$	-5			μA
V_{OH}	Output High Voltage	Refer to NOTE 1	2.6			V
		$I_{OH} = -16\text{mA}$	2.9			V
		$I_{OH} = -100\mu\text{A}$	3			V
V_{OL}	Output Low Voltage	Refer to NOTE 1			0.5	V
		$I_{OL} = 16\text{mA}$			0.25	V
		$I_{OL} = 100\mu\text{A}$			0.15	V

NOTE 1: Outputs terminated with 50Ω to $V_{DDO}/2$. See Parameter Measurement Section, "3.3V Output Load Test Circuit".

TABLE 3D. LVCMOS / LVTTL DC CHARACTERISTICS, $V_{DD} = 3.3V \pm 5\%$, $V_{DDO} = 2.5V \pm 5\%$, $T_A = -40^\circ C$ TO $85^\circ C$

Symbol	Parameter	Test Conditions	Minimum	Typical	Maximum	Units
V_{IH}	Input High Voltage		2		$V_{DD} + 0.3$	V
V_{IL}	Input Low Voltage		-0.3		1.3	V
I_{IH}	Input High Current	$V_{DD} = V_{IN} = 3.465V$			150	μA
I_{IL}	Input Low Current	$V_{DD} = 3.465V, V_{IN} = 0V$	-5			μA
V_{OH}	Output High Voltage; NOTE 1		2.1			V
V_{OL}	Output Low Voltage; NOTE 1				0.5	V

NOTE 1: Outputs terminated with 50Ω to $V_{DDO}/2$. See Parameter Measurement Section, "3.3V/2.5V Output Load Test Circuit".

TABLE 4A. AC CHARACTERISTICS, $V_{DD} = V_{DDO} = 3.3V \pm 5\%$, $T_A = -40^\circ C$ TO $85^\circ C$

Symbol	Parameter	Test Conditions	Minimum	Typical	Maximum	Units
f_{MAX}	Output Frequency				166	MHz
tp_{LH}	Propagation Delay, Low-to-High; NOTE 1	$f \leq 166MHz$	2		3.3	ns
t_{jit}	Buffer Additive Phase Jitter, RMS; refer to Additive Phase Jitter Section	125MHz, Integration Range 12kHz – 20MHz		0.17		ps
$t_{sk(o)}$	Output Skew; NOTE 2, 4	$f = 133MHz$			50	ps
$t_{sk(pp)}$	Part-to-Part Skew; NOTE 3, 4				600	ps
t_R	Output Rise Time	30% to 70%	250		500	ps
t_F	Output Fall Time	30% to 70%	250		500	ps
odc	Output Duty Cycle		40		60	%

NOTE: Electrical parameters are guaranteed over the specified ambient operating temperature range, which is established when the device is mounted in a test socket with maintained transverse airflow greater than 500 lfm. The device will meet specifications after thermal equilibrium has been reached under these conditions.

NOTE: All parameters measured at 166MHz unless noted otherwise.

NOTE 1: Measured from $V_{DD}/2$ of the input to $V_{DDO}/2$ of the output.

NOTE 2: Defined as skew between outputs at the same supply voltage and with equal load conditions. Measured at $V_{DDO}/2$.

NOTE 3: Defined as skew between outputs on different devices operating at the same supply voltages and with equal load conditions. Using the same type of inputs on each device, the outputs are measured at $V_{DDO}/2$.

NOTE 4: This parameter is defined in accordance with JEDEC Standard 65.

TABLE 4B. AC CHARACTERISTICS, $V_{DD} = 3.3V \pm 5\%$, $V_{DDO} = 2.5V \pm 5\%$, $T_A = -40^\circ\text{C}$ TO 85°C

Symbol	Parameter	Test Conditions	Minimum	Typical	Maximum	Units
f_{MAX}	Output Frequency				166	MHz
$t_{p_{LH}}$	Propagation Delay, Low-to-High; NOTE 1	$f \leq 166\text{MHz}$	2.3		3.7	ns
$t_{sk(o)}$	Output Skew; NOTE 2, 4	$f = 133\text{MHz}$			60	ps
$t_{sk(pp)}$	Part-to-Part Skew; NOTE 3, 4				650	ps
t_R	Output Rise Time	30% to 70%	250		500	ps
t_F	Output Fall Time	30% to 70%	250		500	ps
odc	Output Duty Cycle		40		60	%

NOTE: Electrical parameters are guaranteed over the specified ambient operating temperature range, which is established when the device is mounted in a test socket with maintained transverse airflow greater than 500 lfm. The device will meet specifications after thermal equilibrium has been reached under these conditions.

All parameters measured at 166MHz unless noted otherwise.

NOTE 1: Measured from $V_{DD}/2$ of the input to $V_{DDO}/2$ of the output.

NOTE 2: Defined as skew between outputs at the same supply voltage and with equal load conditions.

Measured at $V_{DDO}/2$.

NOTE 3: Defined as skew between outputs on different devices operating at the same supply voltages and with equal load conditions. Using the same type of inputs on each device, the outputs are measured at $V_{DDO}/2$.

NOTE 4: This parameter is defined in accordance with JEDEC Standard 65.

ADDITIVE PHASE JITTER

The spectral purity in a band at a specific offset from the fundamental compared to the power of the fundamental is called the ***dBc Phase Noise***. This value is normally expressed using a Phase noise plot and is most often the specified plot in many applications. Phase noise is defined as the ratio of the noise power present in a 1Hz band at a specified offset from the fundamental frequency to the power value of the fundamental. This ratio is expressed in decibels (dBm) or a ratio of the power in the 1Hz

band to the power in the fundamental. When the required offset is specified, the phase noise is called a ***dBc*** value, which simply means dBm at a specified offset from the fundamental. By investigating jitter in the frequency domain, we get a better understanding of its effects on the desired application over the entire time record of the signal. It is mathematically possible to calculate an expected bit error rate given a phase noise plot.

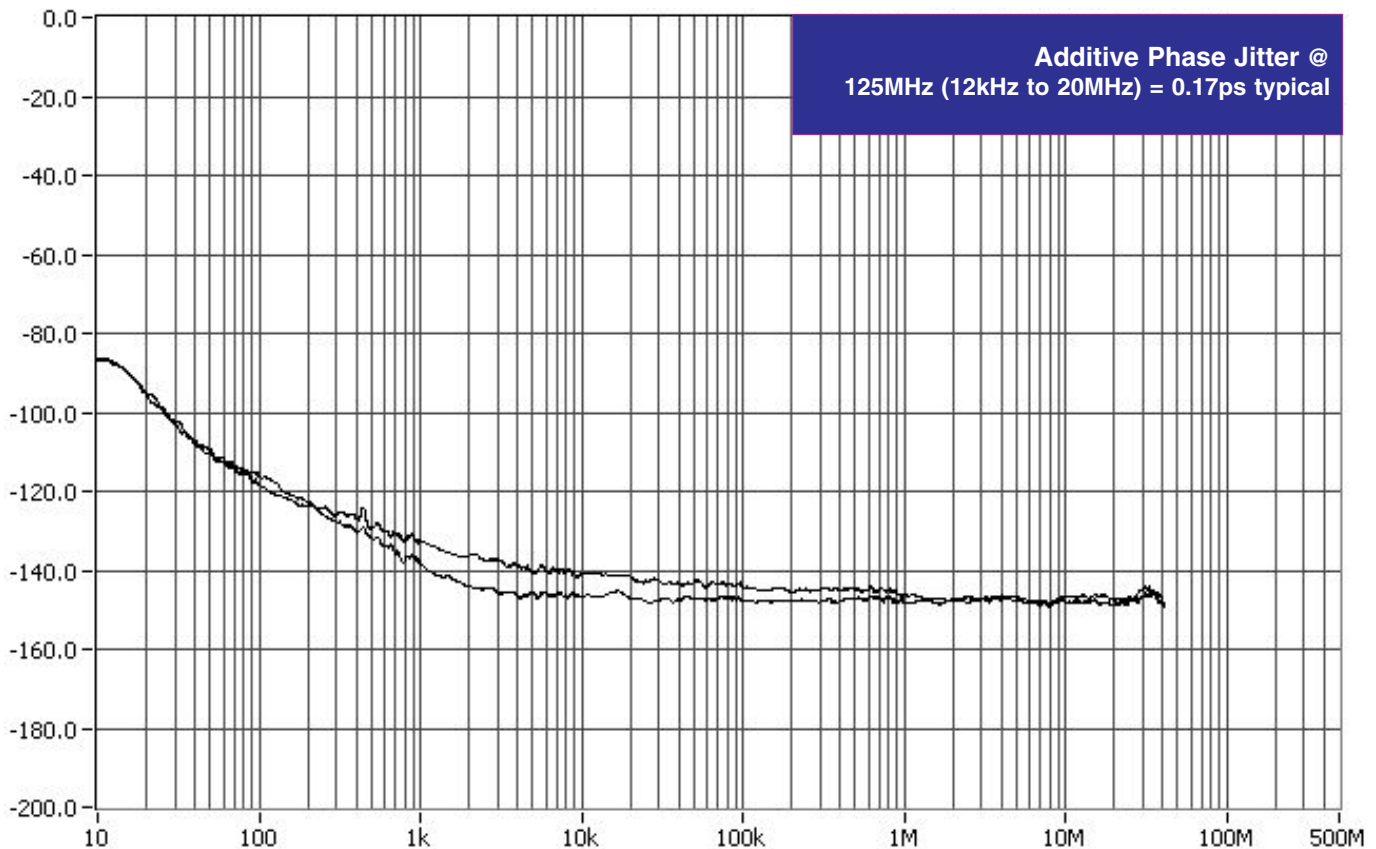

As with most timing specifications, phase noise measurements has issues relating to the limitations of the equipment. Often the noise floor of the equipment is higher than the noise floor of the

device. This is illustrated above. The device meets the noise floor of what is shown, but can actually be lower. The phase noise is dependent on the input source and measurement equipment.

PARAMETER MEASUREMENT INFORMATION

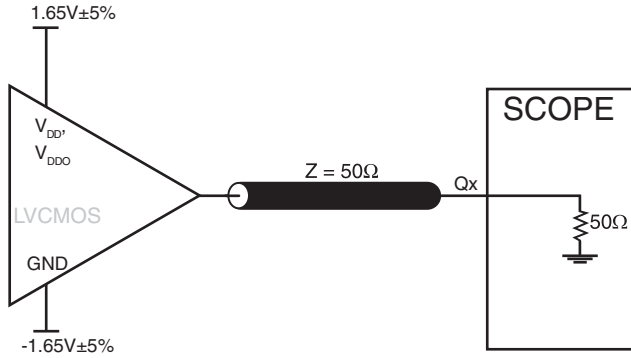

3.3V OUTPUT LOAD AC TEST CIRCUIT

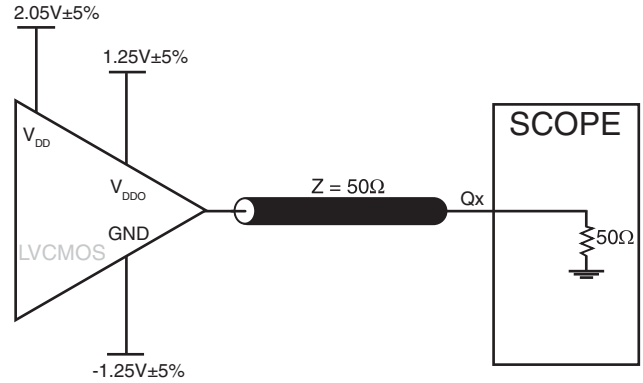

2.5V OUTPUT LOAD AC TEST CIRCUIT

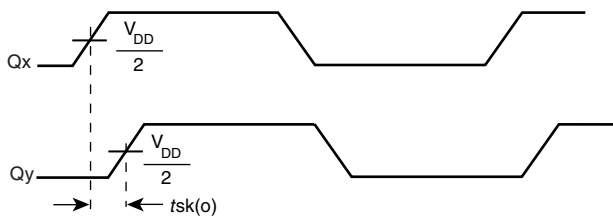

OUTPUT SKEW

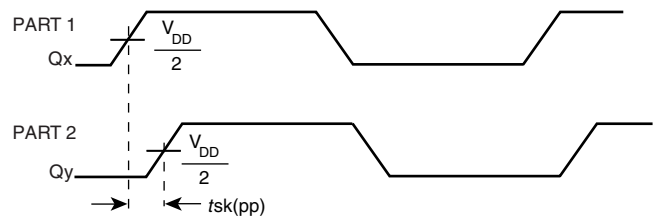

PART-TO-PART SKEW

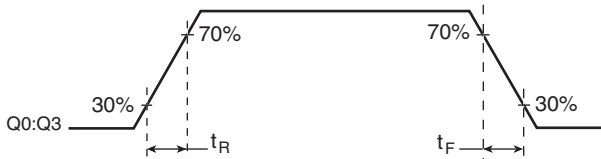

OUTPUT RISE/FALL TIME

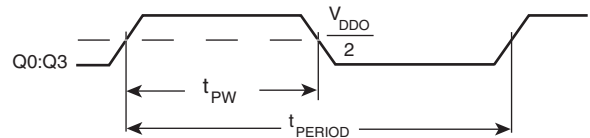

$$odc = \frac{t_{PW}}{t_{PERIOD}} \times 100\%$$

OUTPUT DUTY CYCLE/PULSE WIDTH/PERIOD

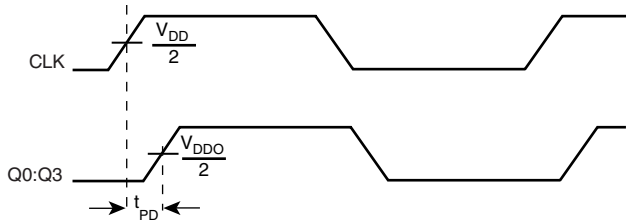

PROPAGATION DELAY

RELIABILITY INFORMATION

TABLE 5. θ_{JA} vs. AIR FLOW TABLE

θ_{JA} by Velocity (Linear Feet per Minute)			
	0	200	500
Single-Layer PCB, JEDEC Standard Test Boards	153.3°C/W	128.5°C/W	115.5°C/W
Multi-Layer PCB, JEDEC Standard Test Boards	112.7°C/W	103.3°C/W	97.1°C/W

NOTE: Most modern PCB designs use multi-layered boards. The data in the second row pertains to most designs.

TRANSISTOR COUNT

The transistor count for ICS83041 is: 416

PACKAGE OUTLINE AND DIMENSIONS

PACKAGE OUTLINE - SUFFIX M FOR 8 LEAD SOIC

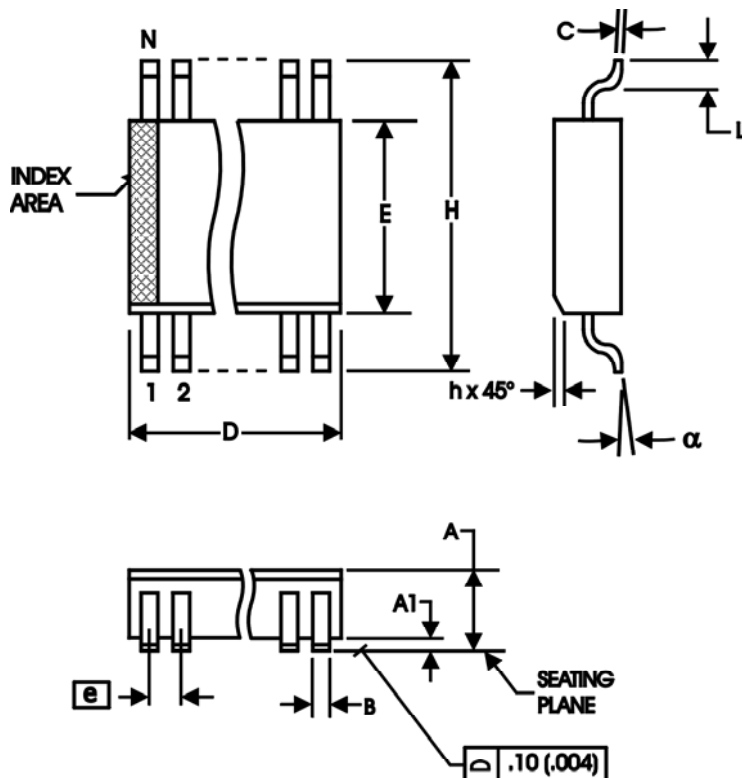

TABLE 6. PACKAGE DIMENSIONS - SUFFIX M

SYMBOL	Millimeters	
	MINIMUM	MAXIMUM
N	8	
A	1.35	1.75
A1	0.10	0.25
B	0.33	0.51
C	0.19	0.25
D	4.80	5.00
E	3.80	4.00
e	1.27 BASIC	
H	5.80	6.20
h	0.25	0.50
L	0.40	1.27
alpha	0°	8°

Reference Document: JEDEC Publication 95, MS-012

TABLE 7. ORDERING INFORMATION

Part/Order Number	Marking	Package	Shipping Packaging	Temperature
8304AMI	8304AMI	8 lead SOIC	tube	-40°C to 85°C
8304AMIT	8304AMI	8 lead SOIC	2500 tape & reel	-40°C to 85°C
8304AMILF	8304AMIL	8 lead "Lead Free" SOIC	tube	-40°C to 85°C
8304AMILFT	8304AMIL	8 lead "Lead Free" SOIC	2500 tape & reel	-40°C to 85°C

NOTE: Parts that are ordered with an "LF" suffix to the part number are the Pb-Free configuration and are RoHS compliant.

While the information presented herein has been checked for both accuracy and reliability, Integrated Device Technology, Incorporated (IDT) assumes no responsibility for either its use or for infringement of any patents or other rights of third parties, which would result from its use. No other circuits, patents, or licenses are implied. This product is intended for use in normal commercial and industrial applications. Any other applications such as those requiring high reliability or other extraordinary environmental requirements are not recommended without additional processing by IDT. IDT reserves the right to change any circuitry or specifications without notice. IDT does not authorize or warrant any IDT product for use in life support devices or critical medical instruments.

REVISION HISTORY SHEET

Rev	Table	Page	Description of Change	Date
B	3B	3	LVCMOS/LVTTL DC Characteristics Table, added I_{OH} and I_{OL} Test Conditions to V_{OH} and V_{OL} rows.	4/4/02
B	T7	1 8	Features Section - added lead-free bullet. Ordering Information Table - added lead-free part number, marking and note. Updated datasheet format.	11/09/06
C	T4A T7	4 6 9	3.3V AC Characteristics Table - added Buffer Additive Phase Jitter spec. Added Buffer Additive Phase Jitter Plot. Ordering Information - Deleted "ICS" from the Part/Order number column.	2/11/09
D	T1 T2	1 2 2	Pin Assignment - corrected "pullup" label to "pulldown" label. Pin Description Table - deleted pullup from note. Pin Characteristics Table - deleted Rpullup row.	10/29/10

ICS8304I

LOW SKEW, 1-TO-4 LVCMOS/LVTTL FANOUT BUFFER

Innovate with IDT and accelerate your future networks. Contact:

www.IDT.com

For Sales

800-345-7015 (inside USA)
+408-284-8200 (outside USA)
Fax: 408-284-2775
www.IDT.com/go/contactIDT

For Tech Support

netcom@idt.com
+480-763-2056

Corporate Headquarters

Integrated Device Technology, Inc.
6024 Silver Creek Valley Road
San Jose, CA 95138
United States
800-345-7015 (inside USA)
+408-284-8200 (outside USA)

