

3-640621-2 ✓ ACTIVE



MTA 100

TE Internal #: 3-640621-2

Standard Rectangular Connectors, Connector Assembly, Receptacle, Mating Retention, Insulation Displacement (IDC), Wire-to-Board, Tin, Normal, MTA 100

[View on TE.com >](#)

Connectors > Rectangular Connectors > Standard Rectangular Connectors > MTA Receptacle: Nylon, Tin Plated, 2.54 mm



Connector Product Type: **Connector Assembly**

Connector & Housing Type: **Receptacle**

Mating Alignment: **Without**

Mating Retention: **With**

Mating Retention Type: **Locking Ramp**

[All MTA Receptacle: Nylon, Tin Plated, 2.54 mm \(167\)](#)

Features

Product Type Features

Compatible With Discrete Wire Type	Stranded
Connector Product Type	Connector Assembly
Connector & Housing Type	Receptacle
Connector System	Wire-to-Board
Insertion Force Type	Normal
Sealable	No
Connector & Contact Terminates To	Wire & Cable

Configuration Features

Number of Cavities	2
Contacts Preloaded	Yes
Number of Positions	2
Number of Rows	1



Electrical Characteristics

Operating Voltage	250 VAC
-------------------	---------

Contact Features

Contact Type	Receptacle
Wire Contact Termination Area Plating Material	Tin
Contact Underplating Material	Nickel
Contact Mating Area Plating Material	Tin
Contact Retention Within Housing	With
Contact Current Rating (Max)	5 A

Termination Features

Termination Method to Wire & Cable	Insulation Displacement (IDC)
------------------------------------	-------------------------------

Mechanical Attachment

Mating Alignment	Without
Mating Retention	With
Mating Retention Type	Locking Ramp
Connector Mounting Type	Cable Mount (Free-Hanging)

Housing Features

Housing Material	Nylon
Housing Color	Natural
Centerline (Pitch)	2.54 mm[.1 in]

Dimensions

Connector Height	13.21 mm[.52 in]
Product Width	7.75 mm[.305 in]
Product Length	5.08 mm[.2 in]
Wire Size	.2 mm ²

Usage Conditions

Operating Temperature Range	-55 – 105 °C[-67 – 221 °F]
-----------------------------	----------------------------

Operation/Application

Shielded	No
Circuit Application	Signal

Industry Standards

CSA Rating	LR 7189
------------	---------



UL Rating	Recognized
Agency/Standard	CSA, UL
Approved Standards	UL E28476
UL Flammability Rating	UL 94V-2

Packaging Features

Packaging Quantity	500
Packaging Method	Bag/Box

Product Compliance

[For compliance documentation, visit the product page on TE.com>](#)

EU RoHS Directive 2011/65/EU	Compliant
EU ELV Directive 2000/53/EC	Compliant
China RoHS 2 Directive MIIT Order No 32, 2016	No Restricted Materials Above Threshold
EU REACH Regulation (EC) No. 1907/2006	Current ECHA Candidate List: JUNE 2023 (235) Candidate List Declared Against: JUNE 2023 (235) Does not contain REACH SVHC
Halogen Content	Low Halogen - Br, Cl, F, I < 900 ppm per homogenous material. Also BFR/CFR/PVC Free
Solder Process Capability	Not applicable for solder process capability

Product Compliance Disclaimer

This information is provided based on reasonable inquiry of our suppliers and represents our current actual knowledge based on the information they provided. This information is subject to change. The part numbers that TE has identified as EU RoHS compliant have a maximum concentration of 0.1% by weight in homogenous materials for lead, hexavalent chromium, mercury, PBB, PBDE, DBP, BBP, DEHP, DIBP, and 0.01% for cadmium, or qualify for an exemption to these limits as defined in the Annexes of Directive 2011/65/EU (RoHS2). Finished electrical and electronic equipment products will be CE marked as required by Directive 2011/65/EU. Components may not be CE marked. Additionally, the part numbers that TE has identified as EU ELV compliant have a maximum concentration of 0.1% by weight in homogenous materials for lead, hexavalent chromium, and mercury, and 0.01% for cadmium, or qualify for an exemption to these limits as defined in the Annexes of Directive 2000/53/EC (ELV). Regarding the REACH Regulation, the information TE provides on SVHC in articles for this part number is based on the latest European Chemicals Agency (ECHA) 'Guidance on requirements for substances in articles' posted at this URL: <https://echa.europa.eu/guidance-documents/guidance-on-reach>

Compatible Parts



TE Part # CAT-104MTA-NTPMP
MTA Plug: Nylon, Tin Plated, 2.54 mm, with Mating Alignment



TE Part # CAT-104MTA-PRUMH
PCB Header: Polyester, Right Angle, 2.54 mm



TE Part # CAT-104MTA-PVBRH
Polyester Vertical PCB Header: 2.54 mm, Breakaway, MTA 100



TE Part # CAT-104MTA-PVUNH
PCB Header: Polyester, Vertical, Unshrouded, No Mating Alignment



TE Part # CAT-104MTA-PRSMH
PCB Header, Right Angle, Polyester, 2.54 mm



TE Part # 640454-2
02P MTA100 HDR ASSY SQ STR POL



TE Part # CAT-104MTA-PRUSH
PCB Header: Polyester, Right Angle, Unshrouded



TE Part # 640550-2
02P MTA100 COVER



TE Part # CAT-104MTA-PVSHH
Polyester Vertical PCB Header: 2.54 mm, Shrouded, MTA 100



TE Part # CAT-104MTA-NYLCC
Nylon PCB Connector Covers: 2.54 mm, MTA 100



TE Part # CAT-104MTA-NVTHH
Nylong Vertical PCB Header: 2.54mm, Through Hole, MTA 100



TE Part # 58074-1
MTA 50/100/156 MANUAL TOOL FRAME



TE Part # 59803-1
MAINTENANCE TOOL



TE Part # 58442-1
MTA 100 CRIMP HEAD PRODUCTION FEED THRU



TE Part # 3-647106-2
02P MTA-100 HDR ASSY,SM,SN



TE Part # 3-644694-2
02P MTA100 R/A HDR RETENTIVE



TE Part # 3-647051-2
02P MTA100 HRD ASSY/L HT LF



TE Part # 58039-1
MTA 100 ARBOR FIXTURE DISCRETE RBN CABLE

Also in the Series | **MTA 100**



Connector Caps & Covers(69)

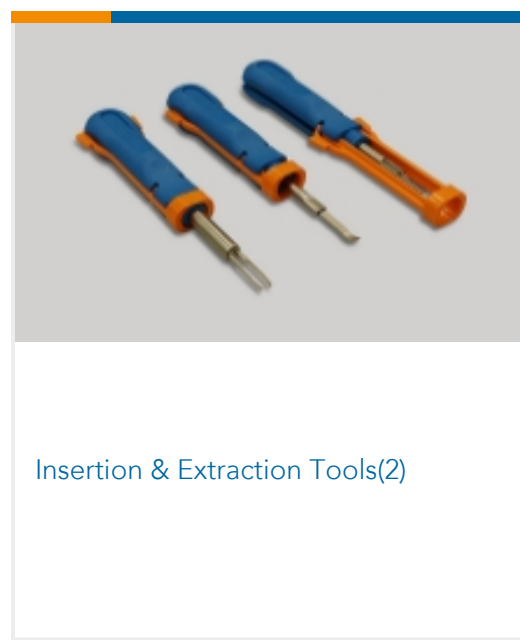

Insertion & Extraction Tools(2)

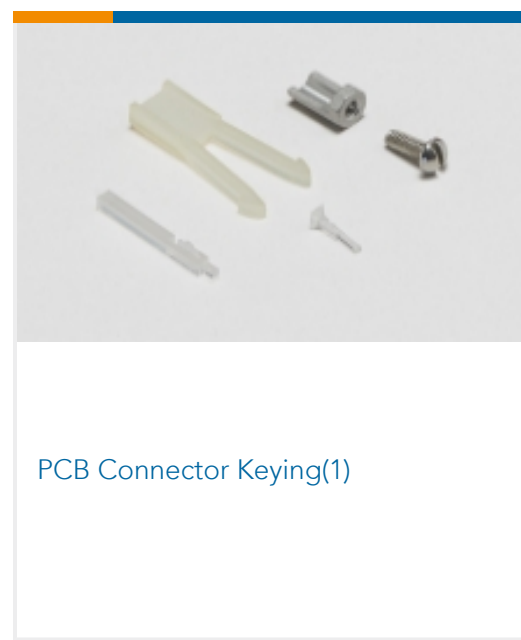

PCB Connector Keying(1)



PCB Headers & Receptacles(440)

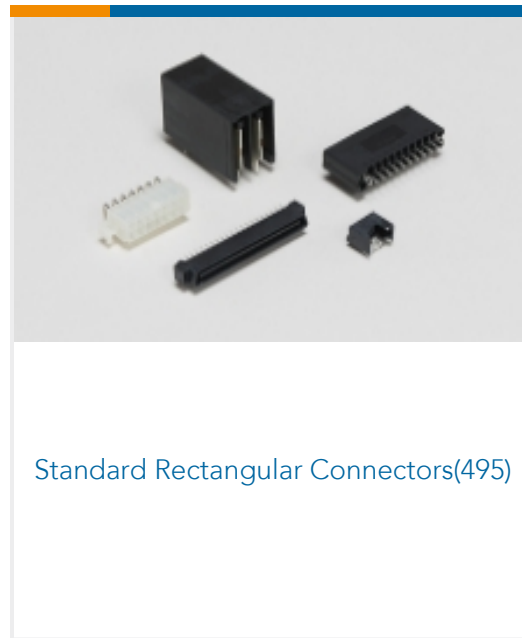

Standard Rectangular Connectors(495)

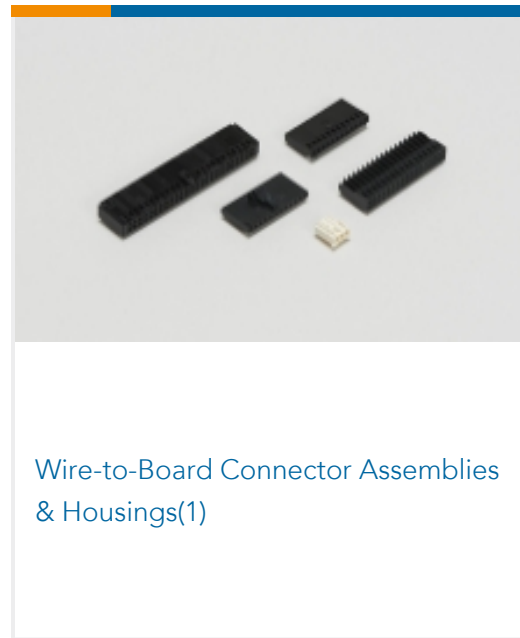

Wire-to-Board Connector Assemblies & Housings(1)

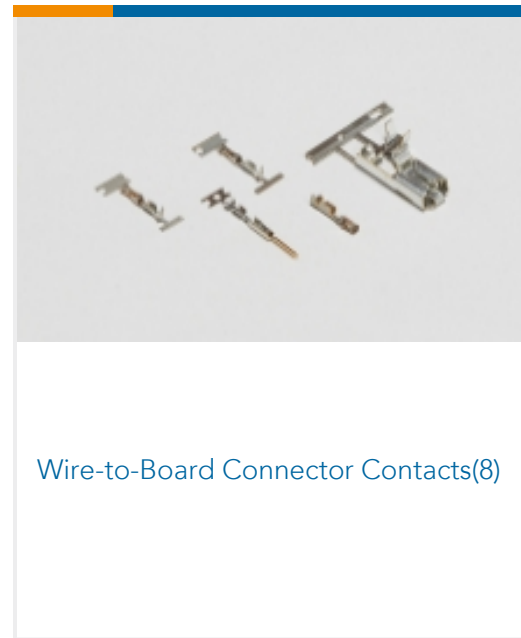

Wire-to-Board Connector Contacts(8)

Customers Also Bought



TE Part #4-640621-0
MTA Receptacle: Nylon, Tin Plated,
2.54 mm



TE Part #34837
TERMINAL,PG R 12-10 1/2



TE Part #2-34072-2
SPLICE,PG BUTT 12-10

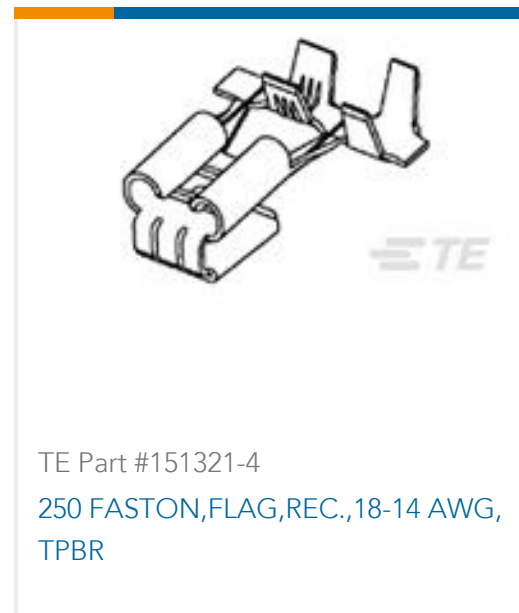

TE Part #151321-4
250 FASTON,FLAG,REC.,18-14 AWG,
TPBR



TE Part #1-1393225-7
RY611005



TE Part #41531-1
250 FASTON FLAG REC 18-12 AWG
NPST



TE Part #1658623-3
16 NOVO MIL 30DP, LEAD FREE



TE Part #41346
RING TERMINAL 18-14 AWG NPSTL

Documents

Product Drawings

02P MTA100 CONN ASSY F/T NATL

English

CAD Files

3D PDF

3D

Customer View Model

ENG_CVM_CVM_3-640621-2_R.2d_dxf.zip



English

Customer View Model

[ENG_CVM_CVM_3-640621-2_R.3d_igs.zip](#)

English

Customer View Model

[ENG_CVM_CVM_3-640621-2_R.3d_stp.zip](#)

English

By downloading the CAD file I accept and agree to the [Terms and Conditions](#) of use.

Product Specifications

[Application Specification](#)

English

Product Environmental Compliance

[MD_3-640621-2_12092015810_dmtec](#)

English

[MD_3-640621-2_12092015810_dmtec](#)

English

Agency Approvals

[Agency Approval Document](#)

English