

Agilent MGA-52543 Low Noise Amplifier Data Sheet

Description

Agilent Technologies' MGA-52543 is an economical, easy-to-use GaAs MMIC Low Noise Amplifier (LNA), which is designed for use in LNA and driver stages. While a capable RF/microwave amplifier for any low noise and high linearity 0.4 to 6 GHz application, the LNA focus is Cellular/PCS base stations.

To attain NF_{min} condition, some simple external matching is required. The MGA-52543 features a calculated NF_{min} of 1.61 dB and 15 dB associated gain at 1.9 GHz from a cascode stage, feedback FET amplifier. The input and output are partially matched to be near 50 Ω .

For base station radio card unit LNA application where better than 2:1 VSWR is required, a series inductor on the input and another series inductor on the output can be added externally. The resulting Noise Figure is typically 1.9 dB with 14 dB Gain at 1.9 GHz. With a single 5.0V supply, the LNA

Simplified Schematic

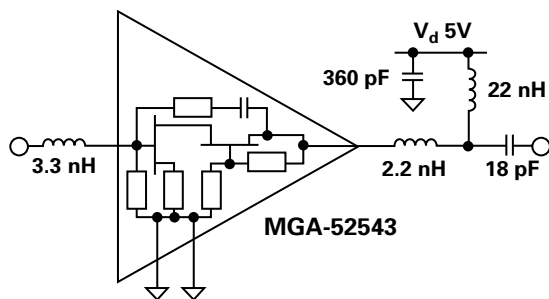

typically draws 53 mA. This alignment results in an Input Intercept Point of 17.5 dBm.

The MGA-52543 is a GaAs MMIC, fabricated using Agilent Technologies' cost-effective, reliable PHEMT (Pseudomorphic High Electron Mobility Transistor) process. It is housed in the SOT-343 (SC70 4-lead) package. This package offers miniature size (1.2 mm by 2.0 mm), thermal dissipation, and RF characteristics.

Surface Mount Package SOT-343 / 4-lead SC70

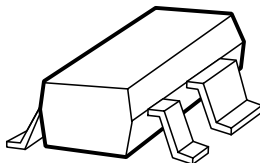

Pin Connections and Package Marking

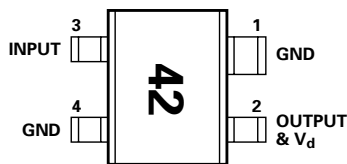

Features

- Lead-free Option Available
- Operating frequency: 0.4 GHz ~ 6.0 GHz
- Minimum noise figure: 1.61 dB at 1.9 GHz
- Associated gain : 15 dB at 1.9 GHz
- 1.9 GHz performance tuned for VSWR < 2:1
Noise figure: 1.9 dB
Gain: 14 dB
 P_{1dB} : +17.5 dBm
Input IP3: +17.5 dBm
- Single supply 5.0 V operation

Applications

- Cellular/PCS base station radio card LNA
- High dynamic range amplifier for base stations, WLL, WLAN, and other applications



Attention:
Observe precautions for handling electrostatic sensitive devices.

ESD Machine Model (Class A)

ESD Human Body Model (Class 1A)

Refer to Agilent Application Note A004R: Electrostatic Discharge Damage and Control.



Agilent Technologies

MGA-52543 Absolute Maximum Ratings^[1]

Symbol	Parameter	Units	Absolute Maximum
V_d	Maximum Input Voltage	V	± 0.5
V_d	Supply Voltage	V	7.0
P_d	Power Dissipation ^[2,3]	mW	425
P_{in}	CW RF Input Power	dBm	+20
T_j	Junction Temperature	$^{\circ}\text{C}$	160
T_{STG}	Storage Temperature	$^{\circ}\text{C}$	-65 to 150

Thermal Resistance:^[2]

$$\theta_{jc} = 150^{\circ}\text{C}/\text{W}$$

Notes:

1. Operation of this device in excess of any of these limits may cause permanent damage.
2. $T_{case} = 25^{\circ}\text{C}$

Electrical Specifications

$T_c = +25^{\circ}\text{C}$, $Z_0 = 50 \Omega$, $V_d = 5\text{V}$, unless noted

Symbol	Parameter and Test Condition	Frequency	Units	Min.	Typ.	Max.	σ ^[3]
I_d test	Current drawn	N/A	mA	45	53	65	3.57
NF ^[1]	Noise Figure	1.9 GHz 0.9 GHz	dB		1.9 1.8	2.3	0.15
Gain ^[1]	Gain	1.9 GHz 0.9 GHz	dB	13	14.2 15	15.5	0.26
IIP3 ^[1]	Input Third Order Intercept Point	1.9 GHz 0.9 GHz	dBm	14	+17.5 +18		2.28
F_{min} ^[2]	Minimum Noise Figure	1.9 GHz 0.9 GHz	dB		1.6 1.5		
G_a ^[2]	Associated Gain at F_{min}	1.9 GHz 0.9 GHz	dB		15.0 16.2		
OIP3 ^[1]	Output Third Order Intercept Point	1.9 GHz 0.9 GHz	dBm		31.7 33.0		
P_{1dB} ^[1]	Output Power at 1 dB Gain Compression	1.9 GHz 0.9 GHz	dBm		+17.4 +18		
RL_{in} ^[1]	Input Return Loss	1.9 GHz 0.9 GHz	dB		11 15		
RL_{out} ^[1]	Output Return Loss	1.9 GHz 0.9 GHz	dB		20 22		
ISOL ^[1]	Isolation $ S_{12} ^2$	1.9 GHz 0.9 GHz	dB		-25 -25		

Notes:

1. Measurements obtained from a fixed narrow band tuning described in Figure 1. This circuit designed to optimize Noise Figure and IIP3 while maintaining VSWR better than 2:1.
2. Minimum Noise Figure and Associated Gain at F_{min} computed from S-parameter and Noise Parameter data measured in an automated NF system.
3. Standard deviation data are based on at least 400 part sample size and 11 wafer lots.

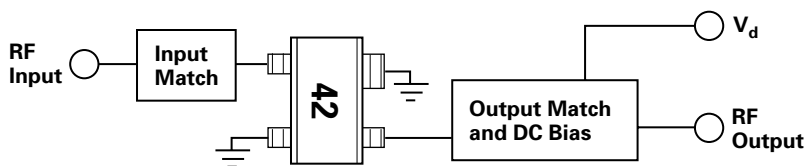

Figure 1. Block Diagram of Test Fixture.

See Figure 7 in the Applications section for an equivalent schematic of 1.9 GHz circuit; Figure 11 in the Applications section for 900 MHz circuit.

MGA-52543 Typical Performance

All data are measured at $T_c = 25^\circ\text{C}$, $V_d = 5\text{V}$, and in the following test system unless stated otherwise.

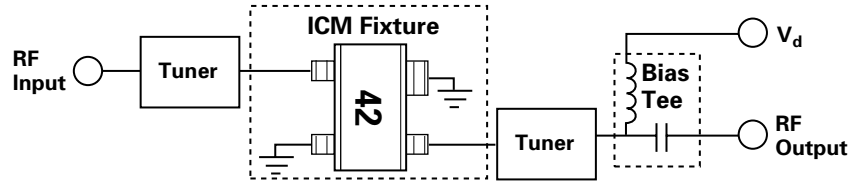

Figure 2. Test Circuit for S, Noise, and Power Parameters over Frequency.

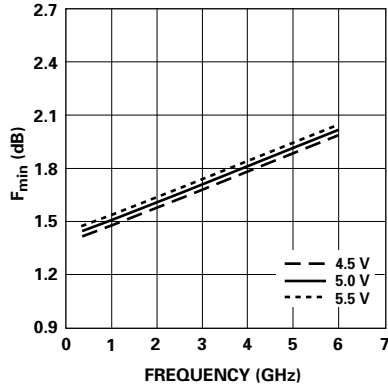

Figure 3. Minimum Noise Figure vs. Frequency and Voltage^[1].

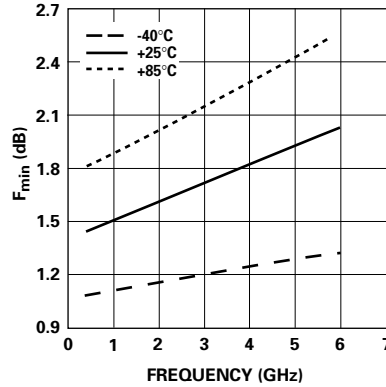

Figure 4. Minimum Noise Figure vs. Frequency and Temperature^[1].

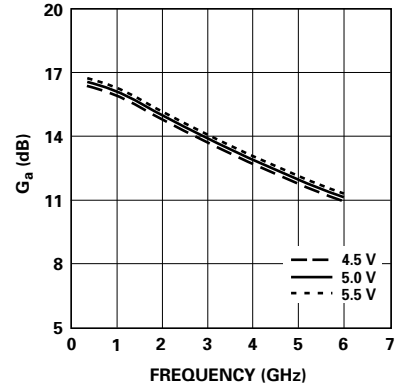

Figure 5. Associated Gain vs. Frequency and Voltage^[1].

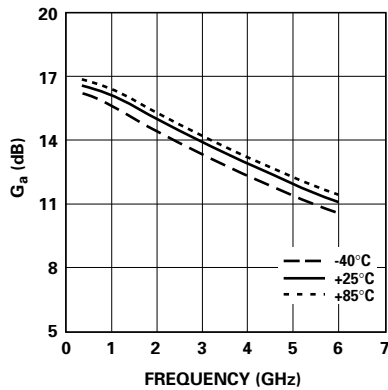

Figure 6. Associated Gain vs. Frequency and Temperature^[1].

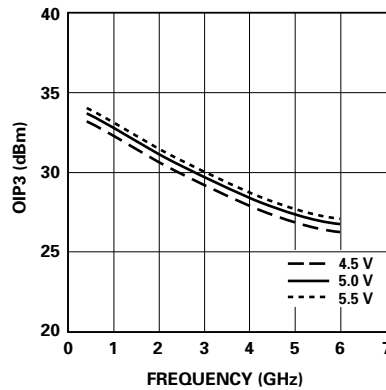

Figure 7. Output Third Order Intercept Point vs. Frequency and Voltage^[2].

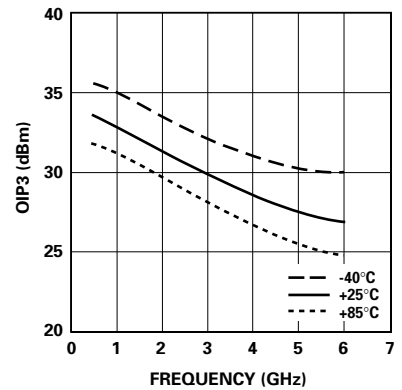

Figure 8. Output Third Order Intercept Point vs. Frequency and Temperature^[2].

Notes:

1. Minimum Noise Figure and Associated Gain at F_{\min} computed from S-parameter and Noise Parameter data measured in an automated NF system.
2. Tuners on input and output were set for narrow band tuning designed to optimize NF and OIP3 while keeping VSWRs better than 2:1. See Figure 9 for corresponding return losses at each frequency band.

MGA-52543 Typical Performance, continued

All data are measured at $T_c = 25^\circ\text{C}$, $V_d = 5\text{V}$, and in the following test system unless stated otherwise.

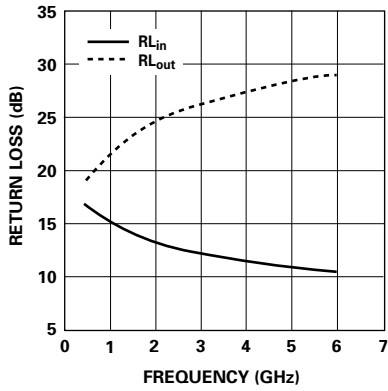

Figure 9. Return Losses at each Narrow Band Tuning.

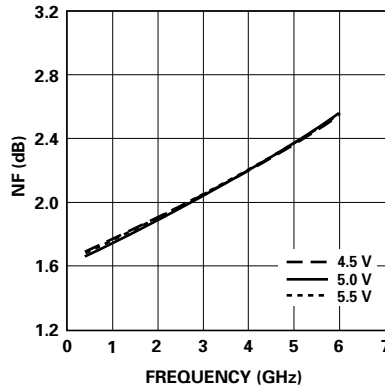

Figure 10. Noise Figure vs. Frequency and Voltage.

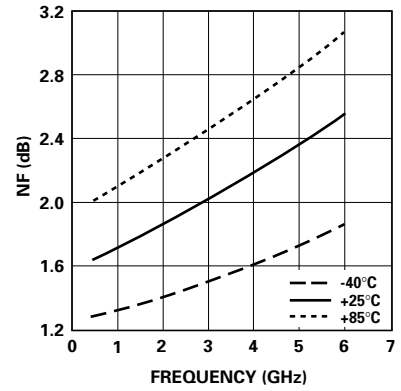

Figure 11. Noise Figure vs. Frequency and Temperature.

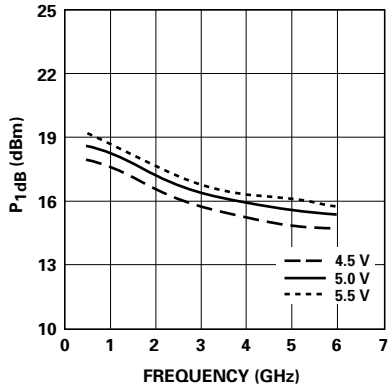

Figure 12. Output Power at 1 dB Compression vs. Frequency and Voltage.

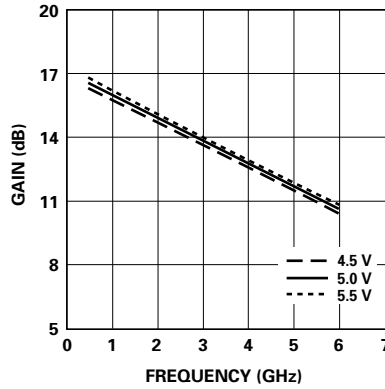

Figure 13. Gain vs. Frequency and Temperature.

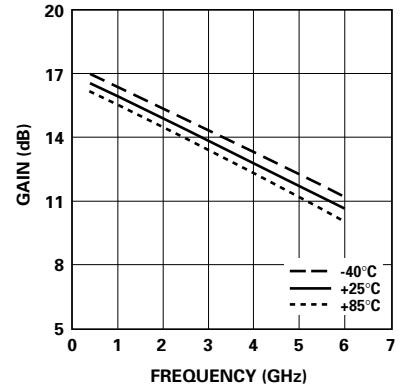

Figure 14. Gain vs. Frequency and Temperature.

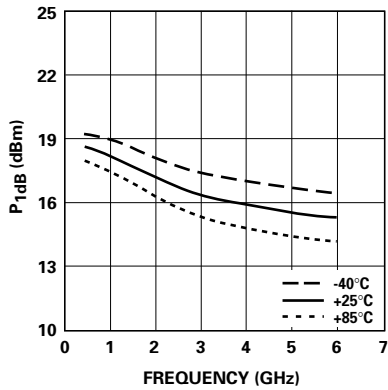

Figure 15. Output Power at 1 dB Compression vs. Frequency and Temperature.

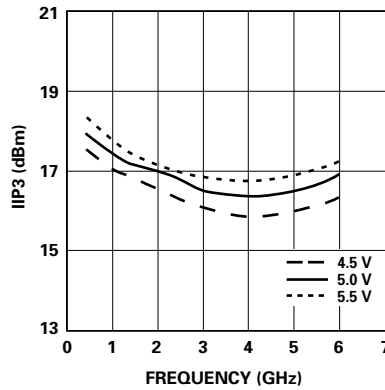

Figure 16. Input Third Order Intercept Point vs. Frequency and Voltage.

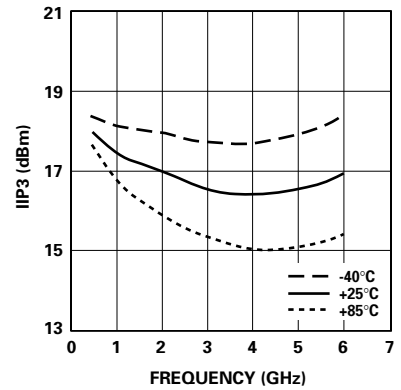

Figure 17. Input Third Order Intercept Point vs. Frequency and Temperature.

Note:

All data reported from Figures 7 through 17 using test setup described in Figure 2. Tuners on input and output were set for narrow band tuning designed to optimize NF and OIP3 while keeping VSWRs better than 2:1. See Figure 9 for corresponding return losses at each frequency band.

MGA-52543 Typical Performance, continued

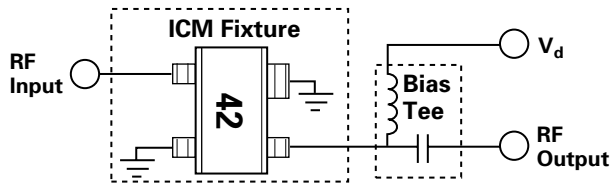

Figure 18. Test Circuit for Figures 19 through 24 (Input and Output presented to 50Ω).

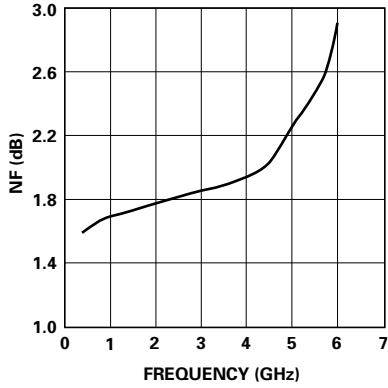

Figure 19. Noise Figure vs. Frequency (in 50Ω).

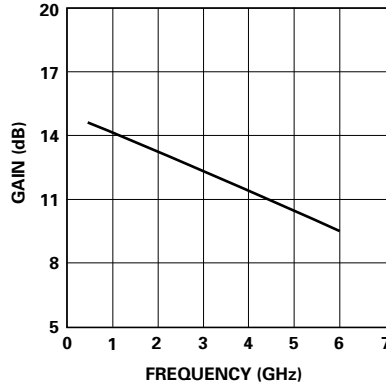

Figure 20. Gain vs. Frequency.

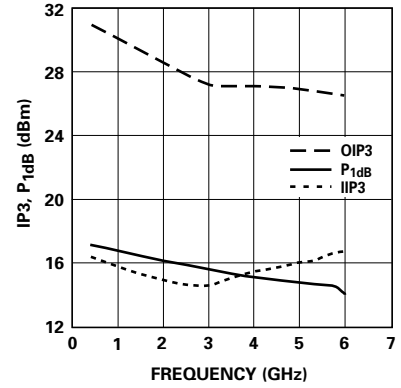

Figure 21. Input IP3, Output IP3 and P_{1dB} vs. Frequency.

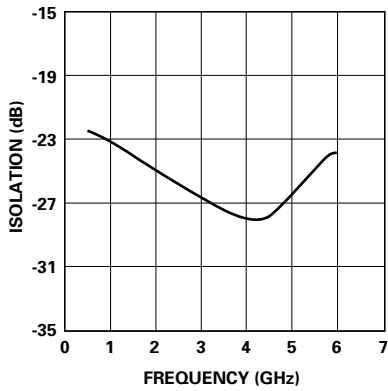

Figure 22. Isolation vs. Frequency.

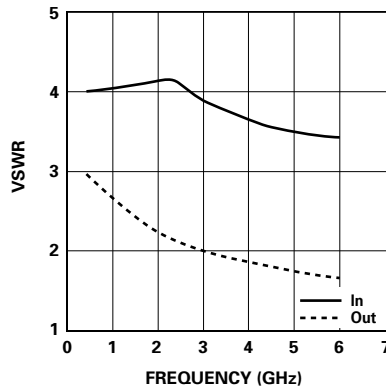

Figure 23. Input and Output VSWR vs. Frequency.

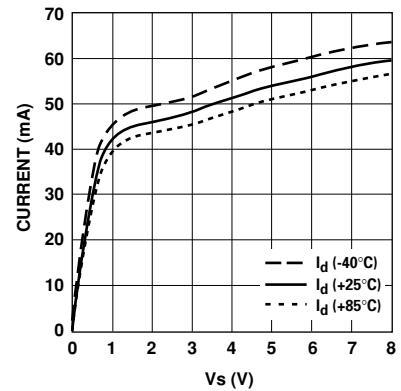

Figure 24. Current vs. V_d.

MGA-52543 Typical Scattering Parameters

$T_C = 25^\circ\text{C}$, $V_d = 5.0\text{V}$, $I_d = 53\text{ mA}$, $Z_0 = 50\ \Omega$, (from S and Noise Parameters in ICM test fixture)

Freq	s_{11} (m)	s_{11} (a)	s_{21} (dB)	s_{21} (m)	s_{21} (a)	s_{12} (dB)	s_{12} (m)	s_{12} (a)	s_{22} (m)	s_{22} (a)	K
0.2	0.64	-17.42	14.92	5.57	168.30	-22.90	0.072	16.89	0.53	-14.49	1.00
0.3	0.62	-18.44	14.76	5.47	166.18	-22.62	0.074	9.26	0.51	-15.38	1.04
0.4	0.61	-20.41	14.67	5.41	163.57	-22.56	0.074	4.62	0.51	-17.35	1.06
0.5	0.60	-23.21	14.60	5.37	160.09	-22.58	0.074	0.54	0.49	-18.04	1.08
0.6	0.60	-26.02	14.54	5.33	156.98	-22.66	0.074	-2.26	0.48	-20.59	1.09
0.7	0.60	-29.01	14.46	5.28	153.79	-22.78	0.073	-4.58	0.48	-23.14	1.10
0.8	0.60	-31.88	14.37	5.23	150.67	-22.92	0.071	-6.59	0.47	-25.89	1.12
0.9	0.60	-35.42	14.28	5.18	147.57	-23.06	0.070	-8.26	0.46	-28.24	1.13
1	0.60	-38.48	14.19	5.13	144.53	-23.23	0.069	-9.68	0.45	-31.05	1.14
1.1	0.60	-41.81	14.10	5.07	141.44	-23.40	0.068	-10.91	0.44	-33.35	1.16
1.2	0.61	-45.23	14.01	5.02	138.48	-23.58	0.066	-12.02	0.44	-35.96	1.17
1.3	0.61	-48.69	13.92	4.96	135.50	-23.76	0.065	-13.01	0.43	-38.26	1.19
1.4	0.61	-52.14	13.82	4.91	132.59	-23.95	0.063	-13.77	0.42	-40.57	1.21
1.5	0.61	-55.73	13.73	4.86	129.67	-24.14	0.062	-14.46	0.41	-42.72	1.22
1.6	0.61	-59.22	13.63	4.80	126.78	-24.34	0.061	-15.00	0.41	-44.90	1.25
1.7	0.61	-62.73	13.54	4.75	123.96	-24.53	0.059	-15.44	0.40	-46.95	1.27
1.8	0.61	-66.34	13.45	4.70	121.14	-24.72	0.058	-15.78	0.39	-48.94	1.29
1.9	0.61	-69.85	13.36	4.66	118.37	-24.93	0.057	-16.07	0.39	-50.92	1.32
2	0.61	-73.41	13.27	4.61	115.53	-25.10	0.056	-16.19	0.38	-52.95	1.34
2.1	0.61	-76.93	13.19	4.57	112.76	-25.29	0.054	-16.23	0.37	-54.81	1.36
2.2	0.61	-80.55	13.10	4.52	109.97	-25.48	0.053	-16.15	0.37	-56.73	1.39
2.3	0.61	-84.18	13.02	4.48	107.22	-25.69	0.052	-16.20	0.36	-58.62	1.42
2.4	0.61	-87.95	12.95	4.44	104.46	-25.88	0.051	-16.12	0.36	-60.36	1.46
2.5	0.60	-91.46	12.87	4.40	101.71	-26.04	0.050	-15.93	0.35	-62.11	1.48
3	0.59	-109.93	12.46	4.20	88.05	-26.89	0.045	-13.42	0.33	-69.84	1.66
3.5	0.58	-128.36	12.02	3.99	74.65	-27.67	0.041	-8.35	0.32	-76.05	1.89
4	0.57	-146.55	11.56	3.79	61.39	-28.07	0.040	-0.44	0.30	-81.51	2.08
4.5	0.56	-164.07	11.10	3.59	48.43	-27.72	0.041	9.10	0.29	-87.17	2.11
5	0.55	179.17	10.60	3.39	35.70	-26.66	0.046	16.13	0.28	-93.37	1.99
5.5	0.55	163.86	10.09	3.19	23.34	-25.28	0.054	19.97	0.26	-101.07	1.81
6	0.55	148.85	9.58	3.01	11.08	-23.76	0.065	20.39	0.25	-111.19	1.62
6.5	0.56	134.84	9.01	2.82	-0.85	-22.33	0.076	17.75	0.24	-124.51	1.48
7	0.57	121.13	8.44	2.64	-12.44	-21.13	0.088	13.58	0.23	-137.46	1.38
7.5	0.58	108.36	7.85	2.47	-23.66	-20.03	0.100	9.01	0.23	-151.87	1.30
8	0.58	95.90	7.25	2.31	-34.68	-19.00	0.112	3.27	0.24	-165.58	1.22

Noise Parameters

Freq (GHz)	F_{\min} (dB)	Γ_{opt} Mag	Γ_{opt} Ang	R_n/Z_0	G_a (dB)
0.5	1.46	0.32	10.51	0.37	16.5
0.8	1.49	0.31	21.95	0.35	16.3
0.9	1.50	0.31	28.21	0.34	16.19
1	1.51	0.3	32.89	0.34	16.1
1.1	1.52	0.3	39.85	0.33	16.0
1.5	1.57	0.29	45.05	0.30	15.61
1.8	1.60	0.28	50.05	0.28	15.2
1.9	1.61	0.28	57.75	0.27	15.02
2	1.62	0.27	59.67	0.27	14.9
2.1	1.63	0.27	63.12	0.26	14.8
2.2	1.64	0.26	64.28	0.26	14.65
2.3	1.65	0.26	68.3	0.25	14.58
2.4	1.66	0.25	75.25	0.24	14.48
2.5	1.68	0.25	78.03	0.24	14.39
3	1.73	0.23	94.06	0.21	13.98
3.5	1.78	0.21	121.52	0.18	13.39
4	1.84	0.2	141.87	0.16	12.9
4.5	1.89	0.21	172.98	0.15	12.45
5	1.94	0.24	-169.13	0.14	12
5.5	2.00	0.28	-146.48	0.16	11.59
6	2.05	0.31	-133.04	0.19	11.1

Part Number Ordering Information

Part Number	No. of Devices	Container
MGA-52543-TR1	3000	7" Reel
MGA-52543-TR2	10000	13" Reel
MGA-52543-BLK	100	antistatic bag
MGA-52543-TR1G	3000	7" Reel
MGA-52543-TR2G	10000	13" Reel
MGA-52543-BLKG	100	antistatic bag

Note: For lead-free option, the part number will have the character "G" at the end.

Package Dimensions

Outline 43

SOT-343 (SC70 4-lead)

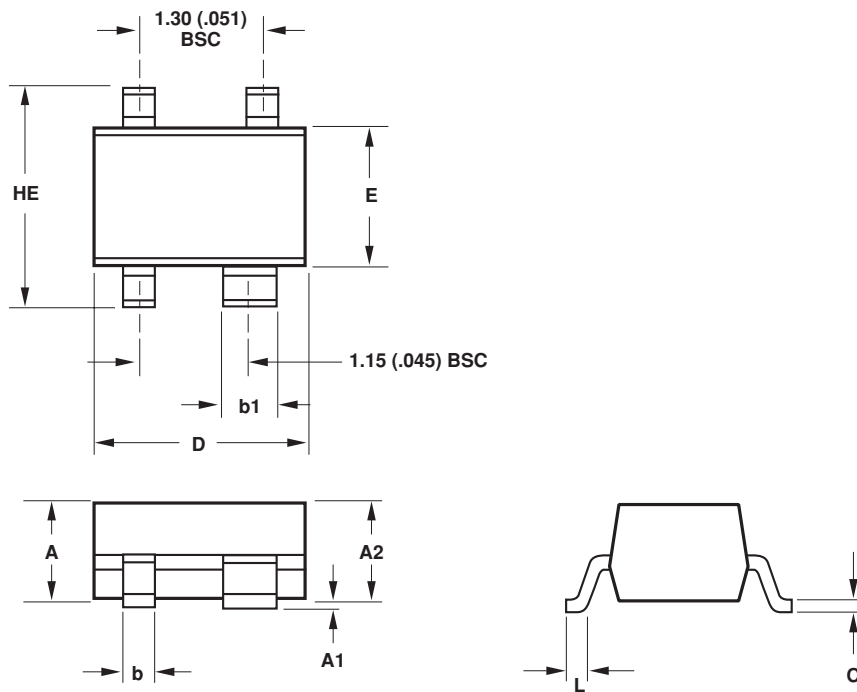

SYMBOL	DIMENSIONS (mm)	
	MIN.	MAX.
E	1.15	1.35
D	1.85	2.25
HE	1.80	2.40
A	0.80	1.10
A2	0.80	1.00
A1	0.00	0.10
b	0.25	0.40
b1	0.55	0.70
c	0.10	0.20
L	0.10	0.46

NOTES:

1. All dimensions are in mm.
2. Dimensions are inclusive of plating.
3. Dimensions are exclusive of mold flash & metal burr.
4. All specifications comply to EIAJ SC70.
5. Die is facing up for mold and facing down for trim/form, ie: reverse trim/form.
6. Package surface to be mirror finish.

Device Orientation

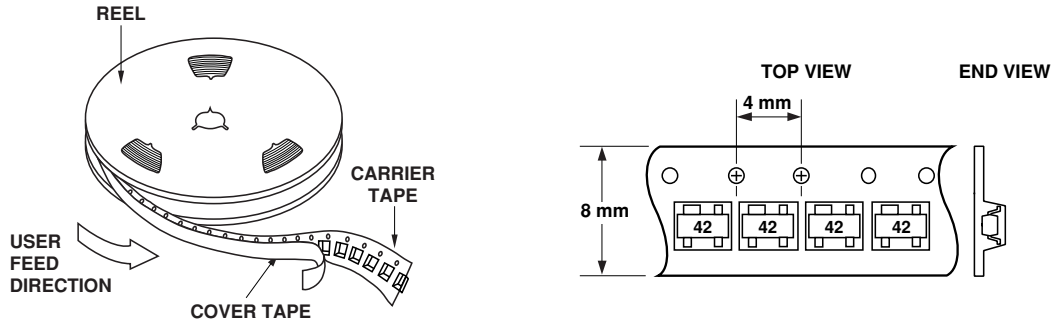

Tape Dimensions For Outline 4T

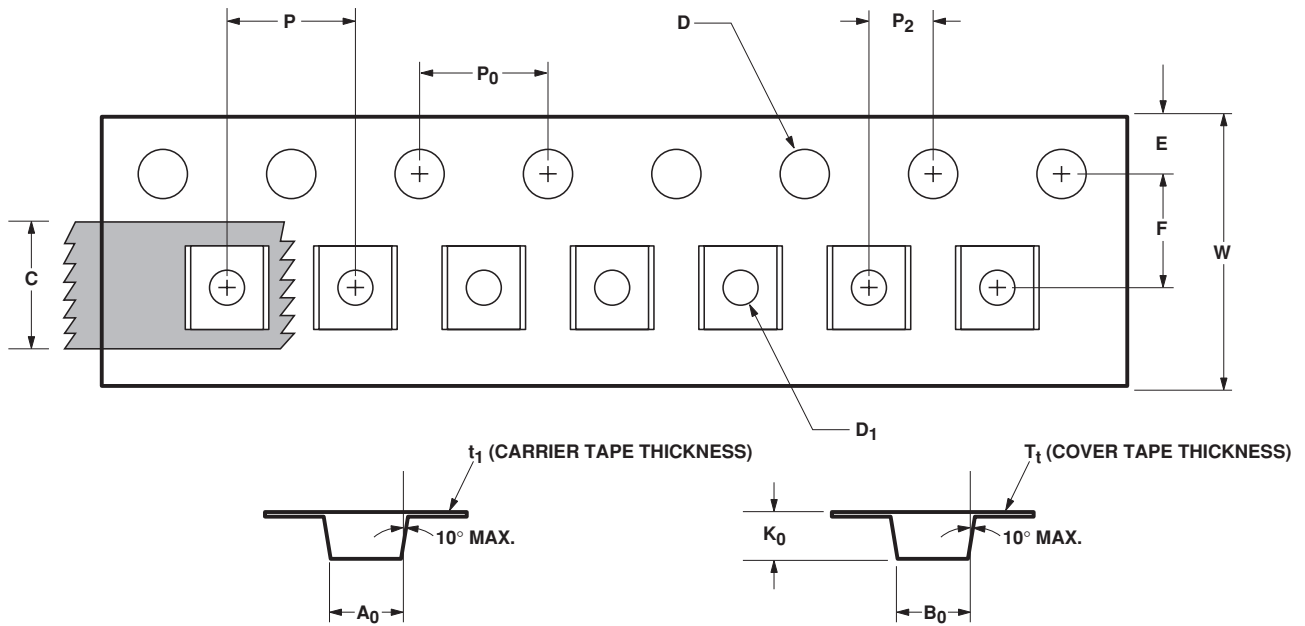

DESCRIPTION		SYMBOL	SIZE (mm)	SIZE (INCHES)
CAVITY	LENGTH	A ₀	2.40 ± 0.10	0.094 ± 0.004
	WIDTH	B ₀	2.40 ± 0.10	0.094 ± 0.004
	DEPTH	K ₀	1.20 ± 0.10	0.047 ± 0.004
	PITCH	P	4.00 ± 0.10	0.157 ± 0.004
	BOTTOM HOLE DIAMETER	D ₁	1.00 + 0.25	0.039 + 0.010
PERFORATION	DIAMETER	D	1.55 ± 0.10	0.061 + 0.002
	PITCH	P ₀	4.00 ± 0.10	0.157 ± 0.004
	POSITION	E	1.75 ± 0.10	0.069 ± 0.004
CARRIER TAPE	WIDTH	W	8.00 + 0.30 - 0.10	0.315 + 0.012
	THICKNESS	t ₁	0.254 ± 0.02	0.0100 ± 0.0008
COVER TAPE	WIDTH	C	5.40 ± 0.10	0.205 + 0.004
	TAPE THICKNESS	T _t	0.062 ± 0.001	0.0025 ± 0.0004
DISTANCE	CAVITY TO PERFORATION (WIDTH DIRECTION)	F	3.50 ± 0.05	0.138 ± 0.002
	CAVITY TO PERFORATION (LENGTH DIRECTION)	P ₂	2.00 ± 0.05	0.079 ± 0.002

MGA-52543 Applications Information

Description

The MGA-52543 is a low noise, linear RFIC amplifier GaAs PHEMT (Pseudomorphic High Electron Mobility Transistor) designed for receiver applications in the 300 MHz to 6.0 GHz frequency range. The device combines low noise performance with high linearity to make it a desirable choice for receiver front end stages as well as driver applications.

The MGA-52543 operates from a +5 volt power supply and draws a nominal current of 55 mA. The RFIC is contained in a miniature SOT-343 (SC-70 4-lead) package to minimize printed circuit board space. This package also offers excellent thermal dissipation and RF characteristics. The device is focused at cellular/PCS basestation applications.

The high frequency response of the MGA-52543 extends through 6 GHz making it an excellent choice for use in 5 GHz RLL as well as 2.4 and 5.7 GHz spread spectrum and ISM/license-free band applications.

Internal, on-chip capacitors limit the low end frequency response to applications above approximately 300 MHz.

Application Guidelines

The MGA-52543 is very easy to use. For most applications, all that is required to operate the MGA-52543 is to apply +5 volts to the RF output pin, and match the RF input and output.

RF Input

To achieve lowest noise figure performance, the input of the MGA-52543 should be matched from the system impedance (typically 50Ω) to the optimum source impedance for minimum noise, Γ_{opt} . Since the real part of the input of the device impedance is near 50Ω and the reactive part is capacitive, a simple series inductor at the input is often all that is needed to provide a suitable noise match for many applications.

RF Output

The RF Output port is closely matched to 50Ω, a simple series inductor at the output will help to improve the input match, gain and power response of the device.

DC Bias

DC bias is applied to the MGA-52543 through the RF Output connection. Figure 1 shows how an inductor (RFC) is used to isolate the RF signal from the DC supply. The bias line is capacitively bypassed to keep RF from the DC supply lines and prevent resonant dips or peaks in the response of the amplifier.

The DC schematic for an MGA-52543 amplifier circuit is shown in Figure 1.

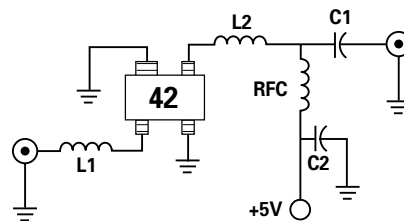

Figure 1. Schematic Diagram with Bias Connections.

A DC blocking capacitor (C1) is used at the output of the MMIC to isolate the supply voltage from succeeding circuits.

While the RF input terminal of the MGA-52543 is at DC ground potential, it should not be used as a current sink. If the input is connected directly to a preceding stage that has a DC voltage present, a blocking capacitor should be used.

Setting the Bias Voltage for Linearity

The MGA-52543 will operate from approximately 2 volts with reduced performance. The MGA-52543 typically pulls 53 mA at 5V. The higher voltage increases amplifier linearity by boosting output power (P_{1dB}) typically from 14 dBm at 3V to 18 dBm at 5V. An absolute maximum recommended supply voltage for this device is 5.5V. Optimum linearity performance is obtained at 5V supply.

Typical performance of gain, noise figure and P_{1dB} output power over a wide range of bias voltage is shown in Figure 2.

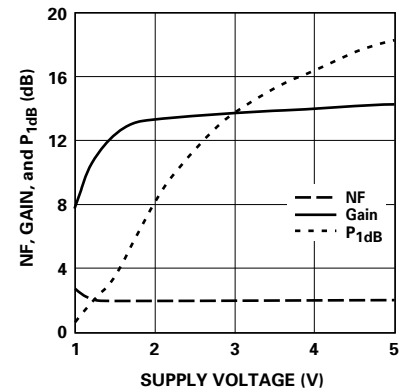

Figure 2. Gain, Noise Figure and Output Power vs. Supply Voltage.

Input and output impedance and noise figure for the amplifier are unaffected by increasing the supply voltage from 3V to 5V.

PCB Layout

A recommended PCB pad layout for the miniature SOT-343 (SC-70) package that is used by the MGA-52543 is shown in Figure 3.

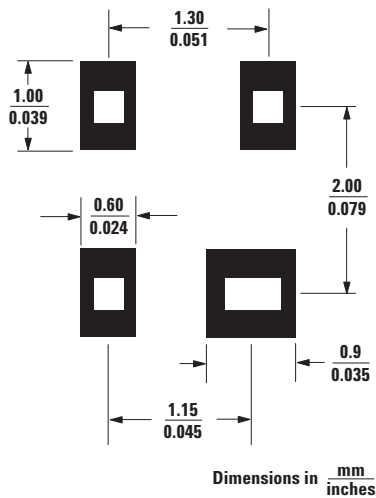

Figure 3. Recommended PCB Pad Layout for Agilent's SC70 4L/SOT-343 Products.

This layout provides ample allowance for package placement by automated assembly equipment without adding parasitics that could impair the high frequency RF performance of the MGA-52543. The layout is shown with a footprint of a SOT-343 package superimposed on the PCB pads for reference.

Starting with the package pad layout in Figure 3, an RF layout similar to the one shown in Figure 4 is a good starting point for microstripline designs using the MGA-52543 amplifier.

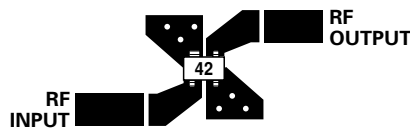

Figure 4. RF Layout.

RF Grounding

Adequate grounding of pins 1 and 4 of the RFIC are important to maintain device stability and RF performance. Each of the ground pins should be connected to the

groundplane on the backside of the PCB by means of plated through holes (vias). The ground vias should be placed as close to the package terminals as practical. At least one via should be located next to each ground pin to assure good RF grounding. It is a good practice to use multiple vias to further minimize ground path inductance.

PCB Materials

FR-4 or G-10 type materials are good choices for most low cost wireless applications using single or multi-layer printed circuit boards. Typical single-layer board thickness is 0.020 to 0.031 inches. Circuit boards thicker than 0.031 inches are not recommended due to excessive inductance in the ground vias.

For noise figure critical or higher frequency applications, the additional cost of PTFE/glass dielectric materials may be warranted to minimize transmission line loss at the amplifier's input.

Application Example

The printed circuit layout in Figure 5 is a multi-purpose layout that will accommodate components for using the MGA-52543 for RF inputs from 100 MHz through 6 GHz. This layout is a microstripline design (solid groundplane on the backside of the circuit board) with 50Ω interfaces for the RF input and output. The circuit is fabricated on 0.031-inch thick FR-4 dielectric material. Plated through holes (vias) are used to bring the ground to the top side of the circuit where needed. Multiple vias are used to reduce the inductance of the paths to ground.

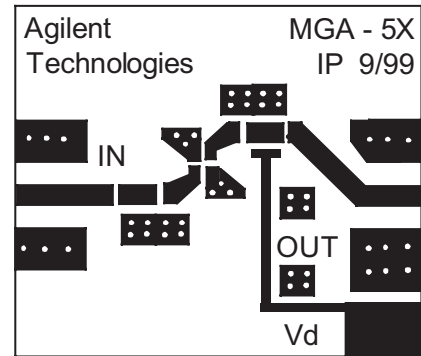

Figure 5. Multi-purpose PCB Layout.

1.9 GHz Design

To illustrate the simplicity of using the MGA-52543, a 1.9 GHz amplifier for PCS type receiver applications is presented.

For low noise amplifier applications, the MGA-52543 is internally matched for low noise figure. The magnitude of Γ_{opt} at 1900 MHz is typically 0.27, additional impedance matching may improve noise figure by 0.1 dB.

Without external matching the typical input return loss for the MGA-52543 is approximately 5 dB. The input return loss may be improved significantly with the addition of a series inductor. At 1900 MHz for example, the addition of a series inductor of 3.3 nH will improve the input return loss to greater than 10 dB.

The output of the MGA-52543 is already well matched to 50Ω and no additional matching is needed. However, using another series inductor on the output of the MGA-52543 significantly improves the output match, gain and the IP3 performance of the device.

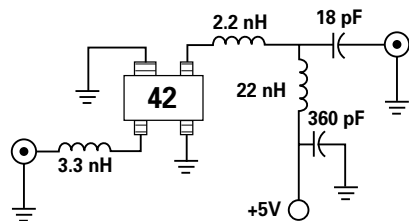

Figure 7. Schematic of 1.9 GHz Circuit.

A schematic diagram of the complete 1.9 GHz circuit with the input and output match and DC biasing is shown in Figure 7. DC bias is applied to the MGA-52543 through the RFC at the RF output pin. The power supply connection is bypassed to ground with capacitor C2. Provision is made for an additional bypass capacitor, C3, to be added to the bias line near the +5 volt connection. C3 will not normally be needed unless several stages are cascaded using a common power supply.

Since the input terminal of the MGA-52543 is at ground potential, an input DC blocking capacitor is not needed unless the amplifier is connected to a preceding stage that has a voltage present at this point. The values of the DC blocking and RF bypass capacitors should be chosen to provide a small reactance (typically $< 5\Omega$) at the lowest operating frequency. For this 1.9 GHz design example, 18 pF capacitors with a reactance of 4.5Ω are adequate. The reactance of the RF choke (RFC) should be high (i.e., several hundred ohms) at the lowest frequency of operation. A 22 nH inductor with a reactance of 262Ω at 1.9 GHz is sufficiently high to minimize the loss from circuit loading.

The completed 1.9 GHz amplifier for this example with all components and SMA connectors assembled is shown in Figure 8.

L1	3.3 nH LL1608-FH3N3
L2	2.2 nH LL2012-F2N2
RFC	22 nH LL1608-FH22N
C1	18 pF chip capacitor
C2	470 pF chip capacitor
C3	10000 pF chip capacitor

Table 1. Component Parts List for the MGA-52543 Amplifier at 1900 MHz.

Performance of MGA-52543 1900 MHz Amplifier

The amplifier is biased at a V_d of 5 volts. The measured noise figure and gain of the completed amplifier is shown in Figure 9. Noise figure is a nominal 2.0 to 2.2 dB from 1800 through 2000 MHz. Gain is a minimum of 14.3 dB from 1800 MHz through 2000 MHz.

Measured input and output return loss is shown in Figure 10. The input return loss at 1900 MHz is 11.2 dB with a corresponding output return loss of 21.9 dB.

The amplifier input intercept point IIP3 was measured at a nominal +17.5 dBm. P_{1dB} measured +17.5 dBm.

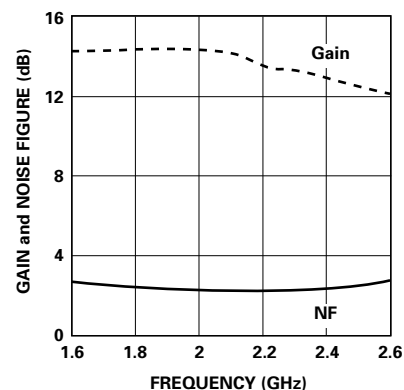

Figure 9. Gain and Noise Figure Results.

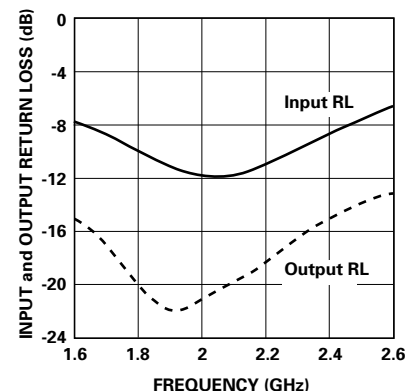

Figure 10. Input and Output Return Loss Results.

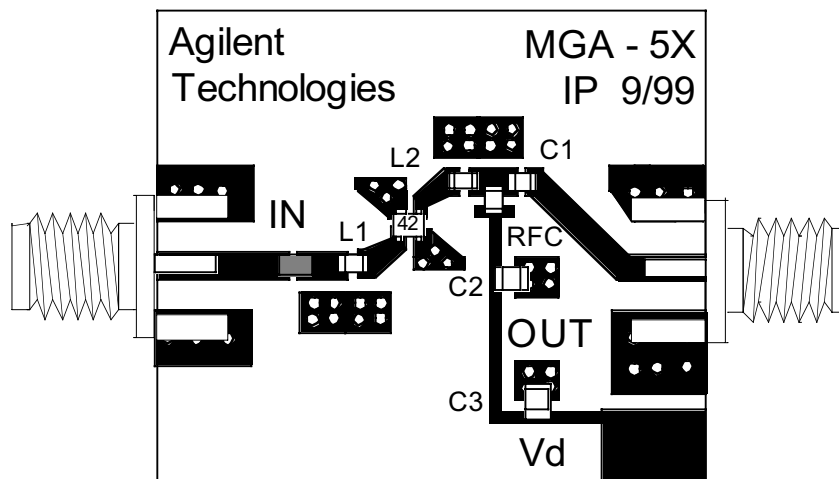

Figure 8. Complete 1.9 GHz Amplifier Circuit.

900 MHz Design

The 900 MHz example follows the same design approach that was described in the previous 1900 MHz design. A schematic diagram of the complete 900 MHz circuit with the input and output match and DC biasing is shown in Figure 11 and the component part list is shown in Table 2. The magnitude of Γ_{opt} at 900 MHz is typically 0.33. See note on designs at other frequencies for more information.

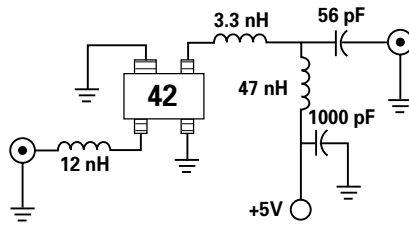

Figure 11. Schematic of 900 MHz Circuit.

L1	12nH LL1608-FH12N
L2	3.3nH LL2012-F3N3
RFC	47nH LL1608-FH47N
C1	56pF chip capacitor
C2	1000pF chip capacitor
C3	10000pF chip capacitor

Table 2. Component Parts List for the MGA-52543 Amplifier at 900 MHz.

Performance of MGA-52543 900 MHz Amplifier

The amplifier is biased at a V_d of 5 volts. The measured noise figure and gain of the completed amplifier is shown in Figure 12. Noise figure is a nominal 2.0 to 2.2 dB from 800 through 1000 MHz. Gain is a minimum of 15.3 dB from 800 MHz through 1000 MHz.

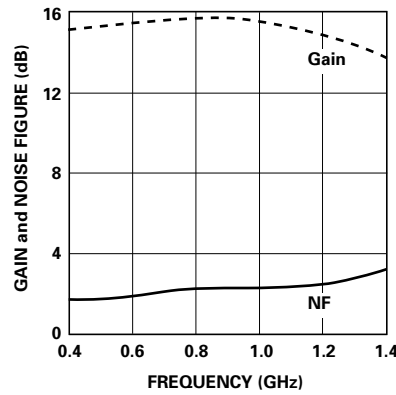

Figure 12. Gain and Noise Figure Results.

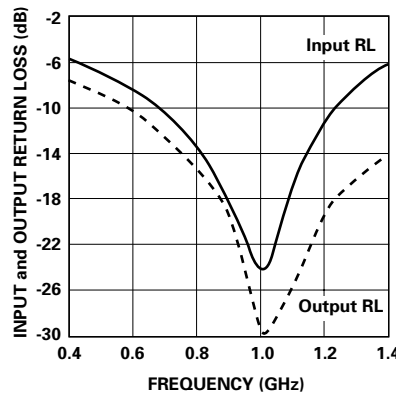

Figure 13. Input and Output Return Loss Results.

Measured input and output return loss is shown in Figure 13. The input return loss at 900 MHz is 15.2 dB with a corresponding output return loss of 21.9 dB.

The amplifier input intercept point IP_3 was measured at a nominal +17.5 dBm. P_{1dB} measured +17.8 dBm.

Designs for Other Frequencies

The same basic design approach described above for 1.9 GHz can be applied to other frequency bands. Inductor values for matching the input for low noise figure are shown in Table 3.

For frequencies below 1000 MHz, the series input inductor approach provides a good match but may not completely noise match the MGA-52543. A two-element matching circuit may be required at lower frequencies to exactly match the input to Γ_{opt} . At lower frequencies, the real part of Γ_{opt} has started to move away from 50 Ω (i.e., away from the $R = 1$ circle on the Smith chart) as the angle of Γ_{opt} decreases. A small shunt capacitor (typically 1.0 pF at 900 MHz to 1.8 pF at 400 MHz) added between the input pin and the adjacent ground pad to create a shunt C-series L matching network will realize an improvement in noise figure of several tenths of a dB. A lower value for L1 may be needed depending on the actual length of the input line between pin 1 and L1 as well as the value of the shunt C.

For frequencies above 3.0 GHz, the input inductor, L1, can be replaced by a small shunt capacitor to optimize the input and noise match.

Frequency	L1, nH	L2, nH	C4, pF
400 MHz	22	8.2	2.2
900 MHz	10	3.3	1.0
1900 MHz	3.3	2.2	none
2.4 GHz	1.5	none	1.0*
3.5GHz	none	none	1.0*
5.8GHz	none	none	0.5

Table 3. Input and Output Inductor Values for Various Operating Frequencies.

Actual component values may differ slightly from those shown in Table 3 due to variations in circuit layout, grounding, and component parasitics. A CAD program such as Agilent Technologies ADS[®] is recommended to fully analyze and account for these circuit variables.

Final Note on Performance

An effective way of lowering production costs is to replace lumped elements with microstrip components. The inductors for the input and output match maybe printed elements as well as lumped elements. To save board space the use of lumped elements at lower frequencies is recommended. The effects of leaving the MGA-52543 unmatched can have a negative effect on the performance of the device. Gain and OIP3 performance are greatly reduced by using the device unmatched. Table 4 gives typical performance at 1900 MHz for the MGA-52543 in an unmatched configuration using the evaluation board shown in Figure 5.

Test	Unmatched Results	Matched Results
Gain	12.5 dB	14.3 dB
OIP3	30.0 dBm	31.8 dBm
IIP3	17.5 dBm	17.5 dBm
P _{1dB}	17.0 dBm	17.5 dBm
Input RL	5.1 dB	10.2 dB
Out RL	10.2 dB	21.9 dB

Table 4. Results of Matching Circuits on MGA-52543.

Hints and Troubleshooting

• Oscillation

Unconditional stability of the MGA-52543 is dependent on having very good grounding. Inadequate device grounding or poor PCB layout techniques could cause the device to be potentially unstable.

Even though a design may be unconditionally stable ($K > 1$ and $B1 > 0$) over its full frequency range, other possibilities exist that may cause an amplifier circuit to oscillate. One thing to check for, is feedback in bias circuits. It is important to capacitively bypass the connections to active bias

circuits to ensure stable operation. In multistage circuits, feedback through bias lines can also lead to oscillation.

Components of insufficient quality for the frequency range of the amplifier can sometimes lead to instability. Also, component values that are chosen to be much higher in value than is appropriate for the application can present a problem. In both of these cases, the components may have reactive parasitics that make their impedances very different than expected. Chip capacitors may have excessive inductance, or chip inductors can exhibit resonances at unexpected frequencies. For example it is a good idea not to use the same type/value of inductors for L1 and L2. It can be shown that if the self-resonant frequency of the inductors used on the input and the output of the MGA-52543 are the same, then the device can be left unterminated at high frequencies.

• A Note on Supply Line Bypassing

Multiple bypass capacitors are normally used throughout the power distribution within a wireless system. Consideration should be given to potential resonances formed by the combination of these capacitors and the inductance of the DC distribution lines. The addition of a small value resistor in the bias supply line between bypass capacitors will often de-Q the bias circuit and eliminate resonance effects.

Statistical Parameters

Several categories of parameters appear within this data sheet. Parameters may be described with values that are either “minimum or maximum,” “typical,” or “standard deviations.”

The values for parameters are based on comprehensive product

characterization data, in which automated measurements are made on of a minimum of 400 parts taken from three non-consecutive process lots of semiconductor wafers. The data derived from product characterization tends to be normally distributed, e.g., fits the standard bell curve.

Parameters considered to be the most important to system performance are bounded by *minimum* or *maximum* values. For the MGA-52543, these parameters are: Input IP3 ($IIP3_{test}$), Gain (G_{test}), Noise Figure (NF_{test}), and Device Current (I_d). Each of the guaranteed parameters is 100% tested as part of the manufacturing process.

Values for most of the parameters in the table of Electrical Specifications that are described by *typical* data are the mathematical mean (μ), of the normal distribution taken from the characterization data. For parameters where measurements or mathematical averaging may not be practical, such as S-parameters or Noise Parameters and the performance curves, the data represents a nominal part taken from the center of the characterization distribution. Typical values are intended to be used as a basis for electrical design.

To assist designers in optimizing not only the immediate amplifier circuit using the MGA-52543, but to also evaluate and optimize trade-offs that affect a complete wireless system, the *standard deviation* (μ) is provided for many of the Electrical Specifications parameters (at 25°C) in addition to the mean. The standard deviation is a measure of the variability about the mean. It will be recalled that a normal distribution is completely described by the mean and standard deviation.

Standard statistics tables or calculations provide the probability of a parameter falling between any two values, usually symmetrically located about the mean. Referring to Figure 14 for example, the probability of a parameter being between $\pm 1\sigma$ is 68.3%; between $\pm 2\sigma$ is 95.4%; and between $\pm 3\sigma$ is 99.7%.

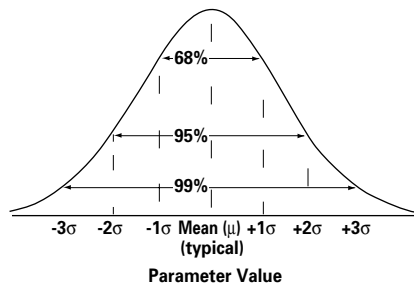

Figure 14. Normal Distribution.

Phase Reference Planes

The positions of the reference planes used to specify S-parameters and Noise Parameters for the MGA-52543 are shown in Figure 15. As seen in the illustration, the reference planes are located at the point where the package leads contact the test circuit.

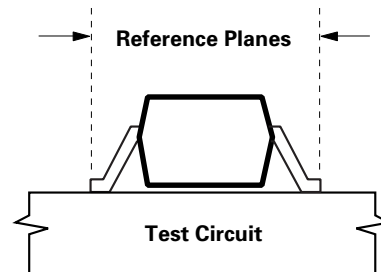

Figure 15. Phase Reference Planes.

www.agilent.com/semiconductors

For product information and a complete list of distributors, please go to our web site.

For technical assistance call:

Americas/Canada: +1 (800) 235-0312 or (916) 788-6763

Europe: +49 (0) 6441 92460

China: 10800 650 0017

Hong Kong: (65) 6756 2394

India, Australia, New Zealand: (65) 6755 1939

Japan: (+81 3) 3335-8152(Domestic/International), or 0120-61-1280(Domestic Only)

Korea: (65) 6755 1989

Singapore, Malaysia, Vietnam, Thailand, Philippines, Indonesia: (65) 6755 2044

Taiwan: (65) 6755 1843

Data subject to change.

Copyright © 2004-2005 Agilent Technologies, Inc.

Obsoletes 5989-3742EN

November 3, 2005

5989-4192EN



Agilent Technologies