

### Features

- Epitaxial Planar Die Construction
- Complementary PNP Type Available (MMST4126)
- Ideal for Medium Power Amplification and Switching
- Ultra-Small Surface Mount Package
- **Available in Lead Free/RoHS Compliant Version (Note 2)**

### Mechanical Data

- Case: SOT-323
- Case Material: Molded Plastic. UL Flammability Classification Rating 94V-0
- Moisture Sensitivity: Level 1 per J-STD-020C
- Terminal Connections: See Diagram
- Terminals: Solderable per MIL-STD-202, Method 208
- Also Available in Lead Free Plating (Matte Tin Finish annealed over Alloy 42 leadframe). Please see Ordering Information, Note 5, on Page 2
- Marking (See Page 2): K1B
- Ordering & Date Code Information: See Page 2
- Weight: 0.006 grams (approximate)

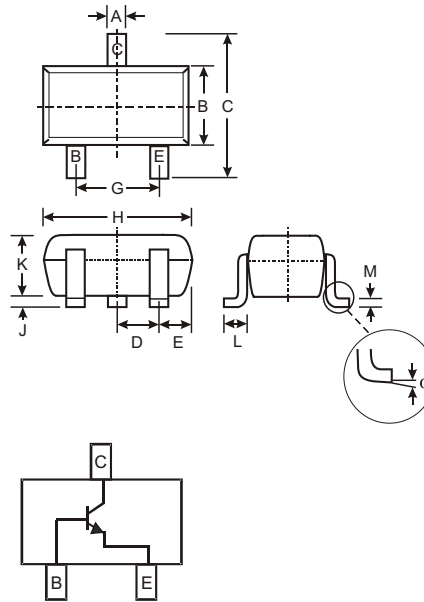

SOT-323		
Dim	Min	Max
A	0.25	0.40
B	1.15	1.35
C	2.00	2.20
D	0.65 Nominal	
E	0.30	0.40
G	1.20	1.40
H	1.80	2.20
J	0.0	0.10
K	0.90	1.00
L	0.25	0.40
M	0.10	0.18
$\alpha$	0°	8°
All Dimensions in mm		

### Maximum Ratings @ $T_A = 25^\circ\text{C}$ unless otherwise specified

Characteristic	Symbol	MMST4124	Unit
Collector-Base Voltage	$V_{CB0}$	30	V
Collector-Emitter Voltage	$V_{CE0}$	25	V
Emitter-Base Voltage	$V_{EB0}$	5.0	V
Collector Current - Continuous (Note 1)	$I_C$	200	mA
Power Dissipation (Note 1)	$P_d$	200	mW
Thermal Resistance, Junction to Ambient (Note 1)	$R_{\theta JA}$	625	K/W
Operating and Storage and Temperature Range	$T_j, T_{STG}$	-55 to +150	$^\circ\text{C}$

- Note: 1. Device mounted on FR-4 PCB, 1 inch x 0.85 inch x 0.062 inch; pad layout as shown on Diodes Inc. suggested pad layout document AP02001, which can be found on our website at <http://www.diodes.com/datasheets/ap02001.pdf>.
2. No purposefully added lead.

## Electrical Characteristics @ $T_A = 25^\circ\text{C}$ unless otherwise specified

Characteristic	Symbol	Min	Max	Unit	Test Condition
<b>OFF CHARACTERISTICS (Note 3)</b>					
Collector-Base Breakdown Voltage	$V_{(BR)CBO}$	30	—	V	$I_C = 10\mu\text{A}$ , $I_E = 0$
Collector-Emitter Breakdown Voltage	$V_{(BR)CEO}$	25	—	V	$I_C = 1.0\text{mA}$ , $I_B = 0$
Emitter-Base Breakdown Voltage	$V_{(BR)EBO}$	5.0	6.0	V	$I_E = 10\mu\text{A}$ , $I_C = 0$
Collector Cutoff Current	$I_{CBO}$	—	50	nA	$V_{CB} = 20\text{V}$ , $I_E = 0\text{V}$
Emitter Cutoff Current	$I_{EBO}$	—	50	nA	$V_{EB} = 3.0\text{V}$ , $I_C = 0\text{V}$
<b>ON CHARACTERISTICS (Note 3)</b>					
DC Current Gain	$h_{FE}$	120 60	360 —	—	$I_C = 2.0\text{mA}$ , $V_{CE} = 1.0\text{V}$ $I_C = 50\text{mA}$ , $V_{CE} = 1.0\text{V}$
Collector-Emitter Saturation Voltage	$V_{CE(SAT)}$	—	0.30	V	$I_C = 50\text{mA}$ , $I_B = 5.0\text{mA}$
Base-Emitter Saturation Voltage	$V_{BE(SAT)}$	—	0.95	V	$I_C = 50\text{mA}$ , $I_B = 5.0\text{mA}$
<b>SMALL SIGNAL CHARACTERISTICS</b>					
Output Capacitance	$C_{obo}$	—	4.0	pF	$V_{CB} = 5.0\text{V}$ , $f = 1.0\text{MHz}$ , $I_E = 0$
Input Capacitance	$C_{ibo}$	—	8.0	pF	$V_{EB} = 0.5\text{V}$ , $f = 1.0\text{MHz}$ , $I_C = 0$
Small Signal Current Gain	$h_{fe}$	120	480	—	$V_{CE} = 1.0\text{V}$ , $I_C = 2.0\text{mA}$ , $f = 1.0\text{kHz}$
Current Gain-Bandwidth Product	$f_T$	300	—	MHz	$V_{CE} = 20\text{V}$ , $I_C = 10\text{mA}$ , $f = 100\text{MHz}$

## Ordering Information (Note 4)

Device	Packaging	Shipping
MMST4124-7	SOT-323	3000/Tape & Reel

- Notes:
3. Short duration test pulse used to minimize self-heating effect.
  4. For Packaging Details, go to our website at <http://www.diodes.com/datasheets/ap02007.pdf>.
  5. For Lead Free/RoHS Compliant version part number, please add "-F" suffix to the part number above. Example: MMST4124-7-F.

## Marking Information

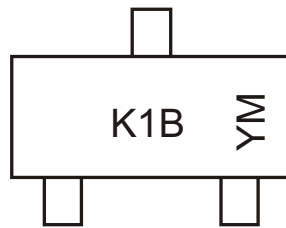

K1B = Product Type Marking Code, ex: K1H = MMSTA05  
 YM = Date Code Marking  
 Y = Year ex: N = 2002  
 M = Month ex: 9 = September

### Date Code Key

Year	1998	1999	2000	2001	2002	2003	2004	2005	2006	2007	2008	2009
Code	J	K	L	M	N	P	R	S	T	U	V	W

Month	Jan	Feb	March	Apr	May	Jun	Jul	Aug	Sep	Oct	Nov	Dec
Code	1	2	3	4	5	6	7	8	9	O	N	D

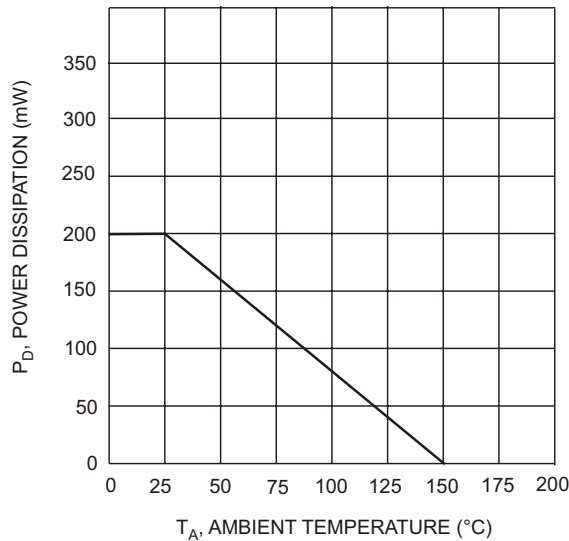

$T_A$ , AMBIENT TEMPERATURE (°C)  
Fig. 1, Max Power Dissipation vs Ambient Temperature

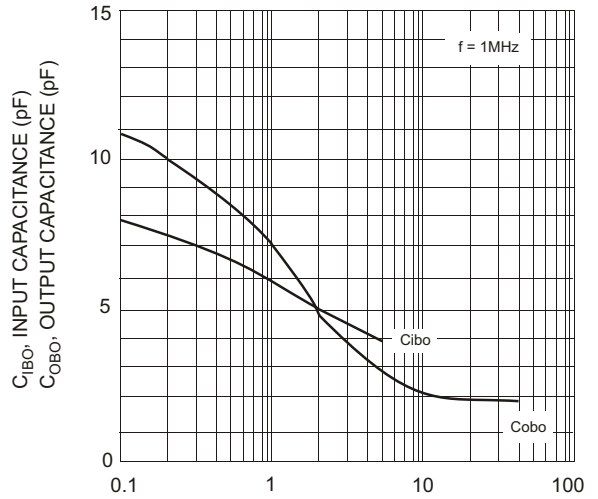

$V_{CB}$ , COLLECTOR-BASE VOLTAGE (V)  
Fig. 2, Input and Output Capacitance vs. Collector-Base Voltage

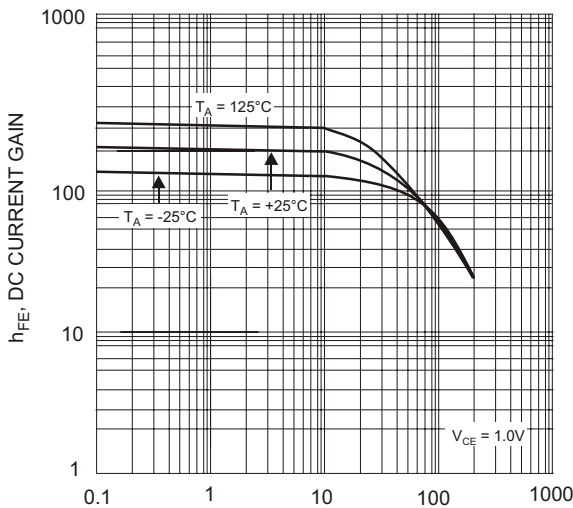

$I_C$ , COLLECTOR CURRENT (mA)  
Fig. 3, Typical DC Current Gain vs Collector Current

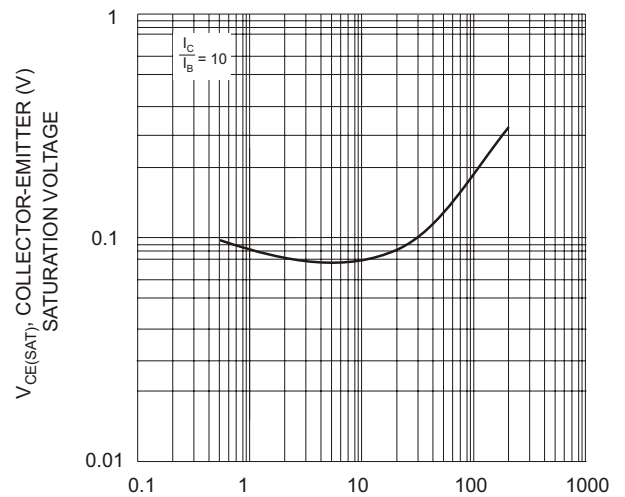

$I_C$ , COLLECTOR CURRENT (mA)  
Fig. 4, Typical Collector-Emitter Saturation Voltage vs. Collector Current

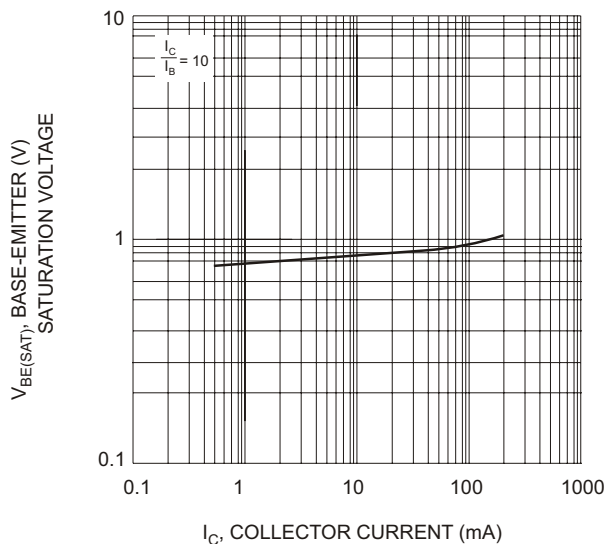

$I_C$ , COLLECTOR CURRENT (mA)  
Fig. 5, Typical Base-Emitter Saturation Voltage vs. Collector Current