

SN54150, SN54151A, SN54LS151, SN54S151, SN74150, SN74151A, SN74LS151, SN74S151 DATA SELECTORS/MULTIPLEXERS

DECEMBER 1972—REVISED MARCH 1988

- '150 Selects One-of-Sixteen Data Sources
- Others Select One-of-Eight Data Sources
- All Perform Parallel-to-Serial Conversion
- All Permit Multiplexing from N Lines to One Line
- Also For Use as Boolean Function Generator
- Input-Clamping Diodes Simplify System Design
- Fully Compatible with Most TTL Circuits

TYPE	TYPICAL AVERAGE	TYPICAL
	PROPAGATION DELAY TIME DATA INPUT TO W OUTPUT	POWER DISSIPATION
'150	13 ns	200 mW
'151A	8 ns	145 mW
'LS151	13 ns	30 mW
'S151	4.5 ns	225 mW

description

These monolithic data selectors/multiplexers contain full on-chip binary decoding to select the desired data source. The '150 selects one-of-sixteen data sources; the '151A, 'LS151, and 'S151 select one-of-eight data sources. The '150, '151A, 'LS151, and 'S151 have a strobe input which must be at a low logic level to enable these devices. A high level at the strobe forces the W output high, and the Y output (as applicable) low.

The '150 has only an inverted W output; the '151A, 'LS151, and 'S151 feature complementary W and Y outputs.

The '151A and '152A incorporate address buffers that have symmetrical propagation delay times through the complementary paths. This reduces the possibility of transients occurring at the output(s) due to changes made at the select inputs, even when the '151A outputs are enabled (i.e., strobe low).

SN54150 . . . J OR W PACKAGE
SN74150 . . . N PACKAGE

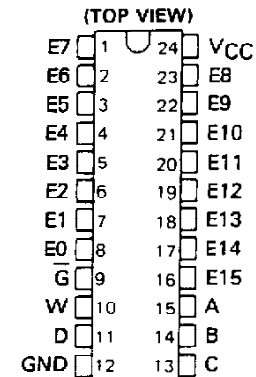

SN54151A, SN54LS151, SN54S151 . . . J OR W PACKAGE
SN74151A . . . N PACKAGE
SN74LS151, SN74S151 . . . D OR N PACKAGE

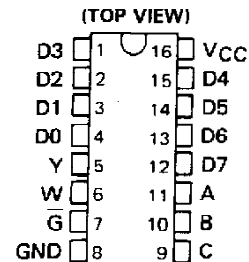

SN54LS151, SN54S151 . . . FK PACKAGE

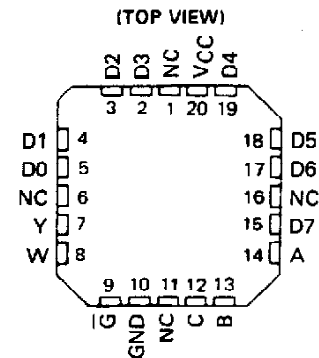

NC - No internal connection

PRODUCTION DATA documents contain information current as of publication date. Products conform to specifications per the terms of Texas Instruments standard warranty. Production processing does not necessarily include testing of all parameters.

TEXAS
INSTRUMENTS

POST OFFICE BOX 655012 • DALLAS, TEXAS 75265

**SN54150, SN54151A, SN54LS151, SN54S151,
SN74150, SN74151A, SN74LS151, SN74S151
DATA SELECTORS/MULTIPLEXERS**

logic symbols†



†These symbols are in accordance with ANSI/IEEE Std. 91-1984 and IEC Publication 617-12. Pin numbers shown are D, J, N, and W packages.

**'150
FUNCTION TABLE**

INPUTS					STROBE \bar{G}	OUTPUT W
SELECT						
D	C	B	A			
X	X	X	X	H	H	
L	L	L	L	L	$\bar{E0}$	
L	L	L	H	L	$\bar{E1}$	
L	L	H	L	L	$\bar{E2}$	
L	L	H	H	L	$\bar{E3}$	
L	H	L	L	L	$\bar{E4}$	
L	H	L	H	L	$\bar{E5}$	
L	H	H	L	L	$\bar{E6}$	
L	H	H	H	L	$\bar{E7}$	
H	L	L	L	L	$\bar{E8}$	
H	L	L	H	L	$\bar{E9}$	
H	L	H	L	L	$\bar{E10}$	
H	L	H	H	L	$\bar{E11}$	
H	H	L	L	L	$\bar{E12}$	
H	H	L	H	L	$\bar{E13}$	
H	H	H	L	L	$\bar{E14}$	
H	H	H	H	L	$\bar{E15}$	

**'151A, 'LS151, 'S151
FUNCTION TABLE**

INPUTS				OUTPUTS	
SELECT			STROBE \bar{G}	Y	W
C	B	A			
X	X	X	H	L	H
L	L	L	L	D0	$\bar{D0}$
L	L	H	L	D1	$\bar{D1}$
L	H	L	L	D2	$\bar{D2}$
L	H	H	L	D3	$\bar{D3}$
H	L	L	L	D4	$\bar{D4}$
H	L	H	L	D5	$\bar{D5}$
H	H	L	L	D6	$\bar{D6}$
H	H	H	L	D7	$\bar{D7}$

H = high level, L = low level, X = irrelevant
 $\bar{E0}, \bar{E1} \dots \bar{E15}$ = the complement of the level of the respective E input
 D0, D1 ... D7 = the level of the D respective input



**SN54150, SN54151A, SN54LS151, SN54S151
SN74150, SN74151A, SN74LS151, SN74S151
DATA SELECTORS/MULTIPLEXERS**

schematics of inputs and outputs

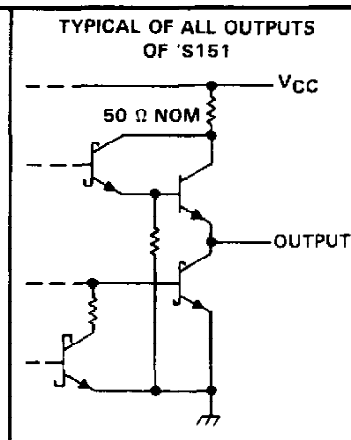
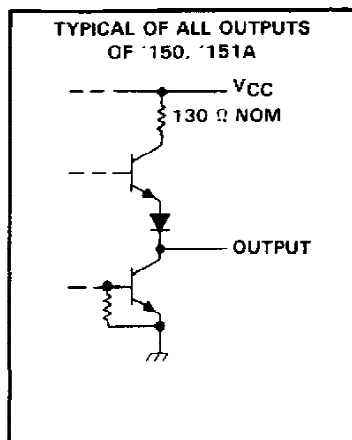
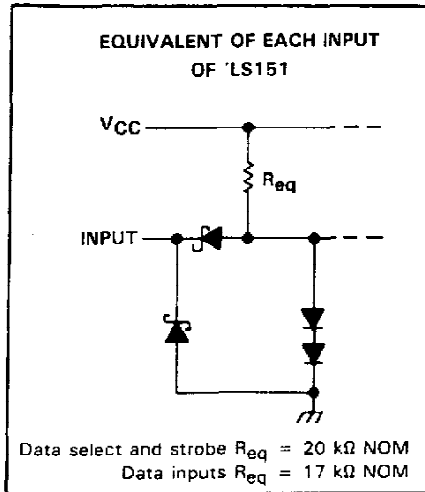

SN54150, SN54151A, SN74150, SN74151A DATA SELECTORS/MULTIPLEXERS

recommended operating conditions

	SN54'			SN74'			UNIT
	MIN	NOM	MAX	MIN	NOM	MAX	
Supply voltage, V_{CC}	4.5	5	5.5	4.75	5	5.25	V
High-level output current, I_{OH}			-800			-800	μ A
Low-level output current, I_{OL}			16			16	mA
Operating free-air temperature, T_A	-55		125	0		70	$^{\circ}$ C

electrical characteristics over recommended operating free-air temperature range (unless otherwise noted)

PARAMETER	TEST CONDITIONS [†]	'150			'151A			UNIT
		MIN	TYP [‡]	MAX	MIN	TYP [‡]	MAX	
V_{IH} High-level input voltage		2			2			V
V_{IL} Low-level input voltage				0.8			0.8	V
V_{IK} Input clamp voltage	$V_{CC} = \text{MIN}$, $I_I = -8 \text{ mA}$			-1.5			-1.5	V
V_{OH} High-level output voltage	$V_{CC} = \text{MIN}$, $V_{IH} = 2 \text{ V}$, $V_{IL} = 0.8 \text{ V}$, $I_{OH} = -800 \mu\text{A}$	2.4	3.4		2.4	3.4		V
V_{OL} Low-level output voltage	$V_{CC} = \text{MIN}$, $V_{IH} = 2 \text{ V}$, $V_{IL} = 0.8 \text{ V}$, $I_{OL} = 16 \text{ mA}$		0.2	0.4		0.2	0.4	V
I_I Input current at maximum input voltage	$V_{CC} = \text{MAX}$, $V_I = 5.5 \text{ V}$			1			1	mA
I_{IH} High-level input current	$V_{CC} = \text{MAX}$, $V_I = 2.4 \text{ V}$			40			40	μ A
I_{IL} Low-level input current	$V_{CC} = \text{MAX}$, $V_I = 0.4 \text{ V}$			-1.6			-1.6	mA
I_{OS} Short-circuit output current [§]	$V_{CC} = \text{MAX}$	SN54'	-20	-55	-20	-55		mA
		SN74'	-18	-55	-18	-55		
I_{CC} Supply current	$V_{CC} = \text{MAX}$. See Note 3		40	68		29	48	mA

[†] For conditions shown as MIN or MAX, use the appropriate value specified under recommended operating conditions for the applicable device type.

[‡] All typical values at $V_{CC} = 5 \text{ V}$, $T_A = 25^{\circ}\text{C}$.

[§] Not more than one output of the '151A should be shorted at a time.

NOTE 3: I_{CC} is measured with the strobe and data select inputs at 4.5 V, all other inputs and outputs open.

switching characteristics, $V_{CC} = 5 \text{ V}$, $T_A = 25^{\circ}\text{C}$

PARAMETER [¶]	FROM (INPUT)	TO (OUTPUT)	TEST CONDITIONS	'150			'151A			UNIT
				MIN	TYP	MAX	MIN	TYP	MAX	
t_{PLH}	A, B, or C (4 levels)	Y	$C_L = 15 \text{ pF}$, $R_L = 400 \Omega$, See Note 4 i				25	38		ns
t_{PHL}							25	38		
t_{PLH}	A, B, C, or D (3 levels)	W		23	35		17	26		ns
t_{PHL}				22	33		19	30		
t_{PLH}	Strobe \bar{G}	Y					21	33		ns
t_{PHL}							22	33		
t_{PLH}	Strobe \bar{G}	W		15.5	24		14	21		ns
t_{PHL}				21	30		15	23		
t_{PLH}	D0 thru D7	Y					13	20		ns
t_{PHL}							18	27		
t_{PLH}	E0 thru E15, or D0 thru D7	W	8.5	14		8	14		ns	
t_{PHL}			13	20		8	14			

[¶] t_{PLH} = propagation delay time, low-to-high-level output

t_{PHL} = propagation delay time, high-to-low-level output

NOTE 4: Load circuits and voltage waveforms are shown in Section 1.

TEXAS
INSTRUMENTS

POST OFFICE BOX 655012 • DALLAS, TEXAS 75265

SN54LS151, SN74LS151 DATA SELECTORS/MULTIPLEXERS

recommended operating conditions

	SN54LS151			SN74LS151			UNIT
	MIN	NOM	MAX	MIN	NOM	MAX	
Supply voltage, V_{CC}	4.5	5	5.5	4.75	5	5.25	V
High-level output current, I_{OH}			-400			-400	μA
Low-level output current, I_{OL}			4			8	mA
Operating free-air temperature, T_A	-55		125	0		70	$^{\circ}C$

electrical characteristics over recommended operating free-air temperature range (unless otherwise noted)

PARAMETER	TEST CONDITIONS†	SN54LS151			SN74LS151			UNIT	
		MIN	TYP‡	MAX	MIN	TYP‡	MAX		
V_{IH} High-level input voltage		2			2			V	
V_{IL} Low-level input voltage				0.7			0.8	V	
V_{IK} Input clamp voltage	$V_{CC} = \text{MIN}, I_I = -18 \text{ mA}$			-1.5			-1.5	V	
V_{OH} High-level output voltage	$V_{CC} = \text{MIN}, V_{IH} = 2 \text{ V}, V_{IL} = V_{ILmax}, I_{OH} = -400 \mu A$	2.5	3.4		2.7	3.4		V	
V_{OL} Low-level output voltage	$V_{CC} = \text{MIN}, V_{IH} = 2 \text{ V}, V_{IL} = V_{ILmax}$			0.25	0.4		0.25	0.4	V
	$I_{OL} = 4 \text{ mA}$ $I_{OL} = 8 \text{ mA}$						0.35	0.5	
I_I Input current at maximum input voltage	$V_{CC} = \text{MAX}, V_I = 7 \text{ V}$			0.1			0.1	mA	
I_{IH} High-level input current	$V_{CC} = \text{MAX}, V_I = 2.7 \text{ V}$			20			20	μA	
I_{IL} Low-level input current	$V_{CC} = \text{MAX}, V_I = 0.4 \text{ V}$			-0.4			-0.4	mA	
I_{OS} Short-circuit output current‡	$V_{CC} = \text{MAX}$			-20		-100	-20	-100	mA
I_{CC} Supply current	$V_{CC} = \text{MAX},$ Outputs open, All inputs at 4.5 V			6.0	10		6.0	10	mA

† For conditions shown as MIN or MAX, use the appropriate value specified under recommended operating conditions for the applicable device type.

‡ All typical values are at $V_{CC} = 5 \text{ V}, T_A = 25^{\circ}C$.

§ Not more than one output should be shorted at a time and duration of short-circuit should not exceed one second.

switching characteristics, $V_{CC} = 5 \text{ V}, T_A = 25^{\circ}C$

PARAMETER†	FROM (INPUT)	TO (OUTPUT)	TEST CONDITIONS	MIN	TYP	MAX	UNIT
t_{PLH}	A, B, or C (4 levels)	Y	$C_L = 15 \text{ pF},$ $R_L = 2 \text{ k}\Omega,$ See Note 4		27	43	ns
t_{PHL}					18	30	
t_{PLH}	A, B, or C (3 levels)	W			14	23	ns
t_{PHL}					20	32	
t_{PLH}	Strobe \bar{G}	Y			26	42	ns
t_{PHL}					20	32	
t_{PLH}	Strobe \bar{G}	W			15	24	ns
t_{PHL}					18	30	
t_{PLH}	Any D	Y			20	32	ns
t_{PHL}					16	26	
t_{PLH}	Any D	W			13	21	ns
t_{PHL}					12	20	

† t_{PLH} = propagation delay time, low-to-high-level output

t_{PHL} = propagation delay time, high-to-low-level output

NOTE 4: Load circuits and voltage waveforms are shown in Section 1.

**TEXAS
INSTRUMENTS**

POST OFFICE BOX 655012 • DALLAS, TEXAS 75265

SN54S151, SN74S151 DATA SELECTORS/MULTIPLEXERS

recommended operating conditions

	SN54S151			SN74S151			UNIT
	MIN	NOM	MAX	MIN	NOM	MAX	
Supply voltage, V_{CC}	4.5	5	5.5	4.75	5	5.25	V
High-level output current, I_{OH}			-1			-1	mA
Low-level output current, I_{OL}			20			20	mA
Operating free-air temperature, T_A	-55		125	0		70	°C

electrical characteristics over recommended operating free-air temperature range (unless otherwise noted)

PARAMETER	TEST CONDITIONS†	MIN	TYP‡	MAX	UNIT
V_{IH} High-level input voltage		2			V
V_{IL} Low-level input voltage				0.8	V
V_{IK} Input clamp voltage	$V_{CC} = \text{MIN}$, $I_I = -18 \text{ mA}$			-1.2	V
V_{OH} High-level output voltage	$V_{CC} = \text{MIN}$, $V_{IH} = 2 \text{ V}$, $V_{IL} = 0.8 \text{ V}$, $I_{OH} = -1 \text{ mA}$	SN54S151	2.5	3.4	V
		SN74S151	2.7	3.4	
V_{OL} Low-level output voltage	$V_{CC} = \text{MIN}$, $V_{IH} = 2 \text{ V}$, $V_{IL} = 0.8 \text{ V}$, $I_{OL} = 20 \text{ mA}$			0.5	V
I_I Input current at maximum input voltage	$V_{CC} = \text{MAX}$, $V_I = 5.5 \text{ V}$			1	mA
I_{IH} High-level input current	$V_{CC} = \text{MAX}$, $V_I = 2.7 \text{ V}$			50	µA
I_{IL} Low-level input current	$V_{CC} = \text{MAX}$, $V_I = 0.5 \text{ V}$			-2	mA
I_{OS} Short-circuit output current §	$V_{CC} = \text{MAX}$	-40		-100	mA
I_{CC} Supply current	$V_{CC} = \text{MAX}$, All inputs at 4.5 V, All outputs open		45	70	mA

† For conditions shown as MIN or MAX, use the appropriate value specified under recommended operating conditions for the applicable device type.

‡ All typical values are at $V_{CC} = 5 \text{ V}$, $T_A = 25^\circ \text{C}$.

§ Not more than one output should be shorted at a time, and duration of the short-circuit should not exceed one second.

switching characteristics, $V_{CC} = 5 \text{ V}$, $T_A = 25^\circ \text{C}$

PARAMETER†	FROM (INPUT)	TO (OUTPUT)	TEST CONDITIONS	MIN	TYP	MAX	UNIT
t_{PLH}	A, B, or C (4 levels)	Y	$C_L = 15 \text{ pF}$, $R_L = 280 \text{ k}\Omega$, See Note 4		12	18	ns
t_{PHL}					12	18	
t_{PLH}	A, B, or C (3 levels)	W			10	15	ns
t_{PHL}					9	13.5	
t_{PLH}	Any D	Y			8	12	ns
t_{PHL}					8	12	
t_{PLH}	Any D	W			4.5	7	ns
t_{PHL}					4.5	7	
t_{PLH}	Strobe \bar{G}	Y			11	16.5	ns
t_{PHL}					12	18	
t_{PLH}	Strobe \bar{G}	W			9	13	ns
t_{PHL}					8.5	12	

† t_{PLH} = propagation delay time, low-to-high-level output

t_{PHL} = propagation delay time, high-to-low-level output

NOTE 4: Load circuits and voltage waveforms are shown in Section 1.

TEXAS
INSTRUMENTS

POST OFFICE BOX 655012 • DALLAS, TEXAS 75265

PACKAGING INFORMATION

Orderable Device	Status ⁽¹⁾	Package Type	Package Drawing	Pins	Package Qty	Eco Plan ⁽²⁾	Lead/Ball Finish	MSL Peak Temp ⁽³⁾
5962-9558001QJA	ACTIVE	CDIP	J	24	1	TBD	Call TI	N / A for Pkg Type
5962-9558001QKA	ACTIVE	CFP	W	24	1	TBD	A42	N / A for Pkg Type
5962-9558001QKA	ACTIVE	CFP	W	24	1	TBD	A42	N / A for Pkg Type
5962-9751601Q2A	OBSOLETE	LCCC	FK	20		TBD	Call TI	Call TI
5962-9751601QCA	OBSOLETE	CDIP	J	14		TBD	Call TI	Call TI
5962-9751601QDA	OBSOLETE	CFP	W	14		TBD	Call TI	Call TI
76010012A	ACTIVE	LCCC	FK	20	1	TBD	POST-PLATE	N / A for Pkg Type
76010012A	ACTIVE	LCCC	FK	20	1	TBD	POST-PLATE	N / A for Pkg Type
7601001EA	ACTIVE	CDIP	J	16	1	TBD	A42	N / A for Pkg Type
7601001EA	ACTIVE	CDIP	J	16	1	TBD	A42	N / A for Pkg Type
7601001FA	ACTIVE	CFP	W	16	1	TBD	A42	N / A for Pkg Type
7601001FA	ACTIVE	CFP	W	16	1	TBD	A42	N / A for Pkg Type
JM38510/01401BKA	ACTIVE	CFP	W	24	1	TBD	A42	N / A for Pkg Type
JM38510/01401BKA	ACTIVE	CFP	W	24	1	TBD	A42	N / A for Pkg Type
JM38510/07901BEA	ACTIVE	CDIP	J	16	1	TBD	A42	N / A for Pkg Type
JM38510/07901BFA	ACTIVE	CFP	W	16	1	TBD	A42	N / A for Pkg Type
JM38510/30901B2A	ACTIVE	LCCC	FK	20	1	TBD	POST-PLATE	N / A for Pkg Type
JM38510/30901B2A	ACTIVE	LCCC	FK	20	1	TBD	POST-PLATE	N / A for Pkg Type
JM38510/30901BEA	ACTIVE	CDIP	J	16	1	TBD	A42	N / A for Pkg Type
JM38510/30901BEA	ACTIVE	CDIP	J	16	1	TBD	A42	N / A for Pkg Type
JM38510/30901BFA	ACTIVE	CFP	W	16	1	TBD	A42	N / A for Pkg Type
JM38510/30901BFA	ACTIVE	CFP	W	16	1	TBD	A42	N / A for Pkg Type
SN54150J	ACTIVE	CDIP	J	24	1	TBD	Call TI	N / A for Pkg Type
SN54150J	ACTIVE	CDIP	J	24	1	TBD	Call TI	N / A for Pkg Type
SN54LS151J	ACTIVE	CDIP	J	16	1	TBD	A42	N / A for Pkg Type
SN54LS151J	ACTIVE	CDIP	J	16	1	TBD	A42	N / A for Pkg Type
SN54S151J	ACTIVE	CDIP	J	16	1	TBD	A42	N / A for Pkg Type
SN54S15J	OBSOLETE	CDIP	J	14		TBD	Call TI	Call TI
SN74150N	ACTIVE	PDIP	N	24	15	Pb-Free (RoHS)	CU NIPDAU	N / A for Pkg Type
SN74150N	ACTIVE	PDIP	N	24	15	Pb-Free (RoHS)	CU NIPDAU	N / A for Pkg Type
SN74150NE4	ACTIVE	PDIP	N	24	15	Pb-Free (RoHS)	CU NIPDAU	N / A for Pkg Type
SN74150NE4	ACTIVE	PDIP	N	24	15	Pb-Free (RoHS)	CU NIPDAU	N / A for Pkg Type
SN74151AN	OBSOLETE	PDIP	N	16		TBD	Call TI	Call TI
SN74151AN	OBSOLETE	PDIP	N	16		TBD	Call TI	Call TI
SN74LS151D	ACTIVE	SOIC	D	16	40	Green (RoHS & no Sb/Br)	CU NIPDAU	Level-1-260C-UNLIM
SN74LS151D	ACTIVE	SOIC	D	16	40	Green (RoHS & no Sb/Br)	CU NIPDAU	Level-1-260C-UNLIM
SN74LS151DE4	ACTIVE	SOIC	D	16	40	Green (RoHS & no Sb/Br)	CU NIPDAU	Level-1-260C-UNLIM

Orderable Device	Status ⁽¹⁾	Package Type	Package Drawing	Pins	Package Qty	Eco Plan ⁽²⁾	Lead/Ball Finish	MSL Peak Temp ⁽³⁾
SN74LS151DE4	ACTIVE	SOIC	D	16	40	Green (RoHS & no Sb/Br)	CU NIPDAU	Level-1-260C-UNLIM
SN74LS151DG4	ACTIVE	SOIC	D	16	40	Green (RoHS & no Sb/Br)	CU NIPDAU	Level-1-260C-UNLIM
SN74LS151DG4	ACTIVE	SOIC	D	16	40	Green (RoHS & no Sb/Br)	CU NIPDAU	Level-1-260C-UNLIM
SN74LS151DR	ACTIVE	SOIC	D	16	2500	Green (RoHS & no Sb/Br)	CU NIPDAU	Level-1-260C-UNLIM
SN74LS151DR	ACTIVE	SOIC	D	16	2500	Green (RoHS & no Sb/Br)	CU NIPDAU	Level-1-260C-UNLIM
SN74LS151DRE4	ACTIVE	SOIC	D	16	2500	Green (RoHS & no Sb/Br)	CU NIPDAU	Level-1-260C-UNLIM
SN74LS151DRE4	ACTIVE	SOIC	D	16	2500	Green (RoHS & no Sb/Br)	CU NIPDAU	Level-1-260C-UNLIM
SN74LS151DRG4	ACTIVE	SOIC	D	16	2500	Green (RoHS & no Sb/Br)	CU NIPDAU	Level-1-260C-UNLIM
SN74LS151DRG4	ACTIVE	SOIC	D	16	2500	Green (RoHS & no Sb/Br)	CU NIPDAU	Level-1-260C-UNLIM
SN74LS151J	OBSOLETE	CDIP	J	16		TBD	Call TI	Call TI
SN74LS151J	OBSOLETE	CDIP	J	16		TBD	Call TI	Call TI
SN74LS151N	ACTIVE	PDIP	N	16	25	Pb-Free (RoHS)	CU NIPDAU	N / A for Pkg Type
SN74LS151N	ACTIVE	PDIP	N	16	25	Pb-Free (RoHS)	CU NIPDAU	N / A for Pkg Type
SN74LS151N3	OBSOLETE	PDIP	N	16		TBD	Call TI	Call TI
SN74LS151N3	OBSOLETE	PDIP	N	16		TBD	Call TI	Call TI
SN74LS151NE4	ACTIVE	PDIP	N	16	25	Pb-Free (RoHS)	CU NIPDAU	N / A for Pkg Type
SN74LS151NE4	ACTIVE	PDIP	N	16	25	Pb-Free (RoHS)	CU NIPDAU	N / A for Pkg Type
SN74LS151NSR	ACTIVE	SO	NS	16	2000	Green (RoHS & no Sb/Br)	CU NIPDAU	Level-1-260C-UNLIM
SN74LS151NSR	ACTIVE	SO	NS	16	2000	Green (RoHS & no Sb/Br)	CU NIPDAU	Level-1-260C-UNLIM
SN74LS151NSRE4	ACTIVE	SO	NS	16	2000	Green (RoHS & no Sb/Br)	CU NIPDAU	Level-1-260C-UNLIM
SN74LS151NSRE4	ACTIVE	SO	NS	16	2000	Green (RoHS & no Sb/Br)	CU NIPDAU	Level-1-260C-UNLIM
SN74LS151NSRG4	ACTIVE	SO	NS	16	2000	Green (RoHS & no Sb/Br)	CU NIPDAU	Level-1-260C-UNLIM
SN74LS151NSRG4	ACTIVE	SO	NS	16	2000	Green (RoHS & no Sb/Br)	CU NIPDAU	Level-1-260C-UNLIM
SN74S151D	NRND	SOIC	D	16	40	Green (RoHS & no Sb/Br)	CU NIPDAU	Level-1-260C-UNLIM
SN74S151D	NRND	SOIC	D	16	40	Green (RoHS & no Sb/Br)	CU NIPDAU	Level-1-260C-UNLIM
SN74S151DE4	NRND	SOIC	D	16	40	Green (RoHS & no Sb/Br)	CU NIPDAU	Level-1-260C-UNLIM
SN74S151DE4	NRND	SOIC	D	16	40	Green (RoHS & no Sb/Br)	CU NIPDAU	Level-1-260C-UNLIM
SN74S151DG4	NRND	SOIC	D	16	40	Green (RoHS & no Sb/Br)	CU NIPDAU	Level-1-260C-UNLIM

Orderable Device	Status ⁽¹⁾	Package Type	Package Drawing	Pins	Package Qty	Eco Plan ⁽²⁾	Lead/Ball Finish	MSL Peak Temp ⁽³⁾
						no Sb/Br)		
SN74S151DG4	NRND	SOIC	D	16	40	Green (RoHS & no Sb/Br)	CU NIPDAU	Level-1-260C-UNLIM
SN74S151N	ACTIVE	PDIP	N	16	25	Pb-Free (RoHS)	CU NIPDAU	N / A for Pkg Type
SN74S151N	ACTIVE	PDIP	N	16	25	Pb-Free (RoHS)	CU NIPDAU	N / A for Pkg Type
SN74S151N3	OBSOLETE	PDIP	N	16		TBD	Call TI	Call TI
SN74S151N3	OBSOLETE	PDIP	N	16		TBD	Call TI	Call TI
SN74S151NE4	ACTIVE	PDIP	N	16	25	Pb-Free (RoHS)	CU NIPDAU	N / A for Pkg Type
SN74S151NE4	ACTIVE	PDIP	N	16	25	Pb-Free (RoHS)	CU NIPDAU	N / A for Pkg Type
SNJ54150J	ACTIVE	CDIP	J	24	1	TBD	Call TI	N / A for Pkg Type
SNJ54150J	ACTIVE	CDIP	J	24	1	TBD	Call TI	N / A for Pkg Type
SNJ54150W	ACTIVE	CFP	W	24	1	TBD	A42	N / A for Pkg Type
SNJ54150W	ACTIVE	CFP	W	24	1	TBD	A42	N / A for Pkg Type
SNJ54LS151FK	ACTIVE	LCCC	FK	20	1	TBD	POST-PLATE	N / A for Pkg Type
SNJ54LS151FK	ACTIVE	LCCC	FK	20	1	TBD	POST-PLATE	N / A for Pkg Type
SNJ54LS151J	ACTIVE	CDIP	J	16	1	TBD	A42	N / A for Pkg Type
SNJ54LS151J	ACTIVE	CDIP	J	16	1	TBD	A42	N / A for Pkg Type
SNJ54LS151W	ACTIVE	CFP	W	16	1	TBD	A42	N / A for Pkg Type
SNJ54LS151W	ACTIVE	CFP	W	16	1	TBD	A42	N / A for Pkg Type
SNJ54S151FK	ACTIVE	LCCC	FK	20	1	TBD	POST-PLATE	N / A for Pkg Type
SNJ54S151J	ACTIVE	CDIP	J	16	1	TBD	A42	N / A for Pkg Type
SNJ54S151W	ACTIVE	CFP	W	16	1	TBD	A42	N / A for Pkg Type
SNJ54S15FK	OBSOLETE	LCCC	FK	20		TBD	Call TI	Call TI
SNJ54S15J	OBSOLETE	CDIP	J	14		TBD	Call TI	Call TI
SNJ54S15W	OBSOLETE	CFP	W	14		TBD	Call TI	Call TI

⁽¹⁾ The marketing status values are defined as follows:

ACTIVE: Product device recommended for new designs.

LIFEBUY: TI has announced that the device will be discontinued, and a lifetime-buy period is in effect.

NRND: Not recommended for new designs. Device is in production to support existing customers, but TI does not recommend using this part in a new design.

PREVIEW: Device has been announced but is not in production. Samples may or may not be available.

OBSOLETE: TI has discontinued the production of the device.

⁽²⁾ Eco Plan - The planned eco-friendly classification: Pb-Free (RoHS), Pb-Free (RoHS Exempt), or Green (RoHS & no Sb/Br) - please check <http://www.ti.com/productcontent> for the latest availability information and additional product content details.

TBD: The Pb-Free/Green conversion plan has not been defined.

Pb-Free (RoHS): TI's terms "Lead-Free" or "Pb-Free" mean semiconductor products that are compatible with the current RoHS requirements for all 6 substances, including the requirement that lead not exceed 0.1% by weight in homogeneous materials. Where designed to be soldered at high temperatures, TI Pb-Free products are suitable for use in specified lead-free processes.

Pb-Free (RoHS Exempt): This component has a RoHS exemption for either 1) lead-based flip-chip solder bumps used between the die and package, or 2) lead-based die adhesive used between the die and leadframe. The component is otherwise considered Pb-Free (RoHS compatible) as defined above.

Green (RoHS & no Sb/Br): TI defines "Green" to mean Pb-Free (RoHS compatible), and free of Bromine (Br) and Antimony (Sb) based flame retardants (Br or Sb do not exceed 0.1% by weight in homogeneous material)

⁽³⁾ MSL, Peak Temp. -- The Moisture Sensitivity Level rating according to the JEDEC industry standard classifications, and peak solder

temperature.

Important Information and Disclaimer:The information provided on this page represents TI's knowledge and belief as of the date that it is provided. TI bases its knowledge and belief on information provided by third parties, and makes no representation or warranty as to the accuracy of such information. Efforts are underway to better integrate information from third parties. TI has taken and continues to take reasonable steps to provide representative and accurate information but may not have conducted destructive testing or chemical analysis on incoming materials and chemicals. TI and TI suppliers consider certain information to be proprietary, and thus CAS numbers and other limited information may not be available for release.

In no event shall TI's liability arising out of such information exceed the total purchase price of the TI part(s) at issue in this document sold by TI to Customer on an annual basis.

OTHER QUALIFIED VERSIONS OF SN54150, SN54LS151, SN54S15, SN54S151, SN74150, SN74LS151, SN74S151 :

- Catalog: [SN74S15](#)

NOTE: Qualified Version Definitions:

- Catalog - TI's standard catalog product

TAPE AND REEL INFORMATION

QUADRANT ASSIGNMENTS FOR PIN 1 ORIENTATION IN TAPE

*All dimensions are nominal

Device	Package Type	Package Drawing	Pins	SPQ	Reel Diameter (mm)	Reel Width W1 (mm)	A0 (mm)	B0 (mm)	K0 (mm)	P1 (mm)	W (mm)	Pin1 Quadrant
SN74LS151DR	SOIC	D	16	2500	330.0	16.4	6.5	10.3	2.1	8.0	16.0	Q1
SN74LS151NSR	SO	NS	16	2000	330.0	16.4	8.2	10.5	2.5	12.0	16.0	Q1

TAPE AND REEL BOX DIMENSIONS



*All dimensions are nominal

Device	Package Type	Package Drawing	Pins	SPQ	Length (mm)	Width (mm)	Height (mm)
SN74LS151DR	SOIC	D	16	2500	333.2	345.9	28.6
SN74LS151NSR	SO	NS	16	2000	346.0	346.0	33.0

J (R-GDIP-T**)

CERAMIC DUAL-IN-LINE PACKAGE

24 PINS SHOWN

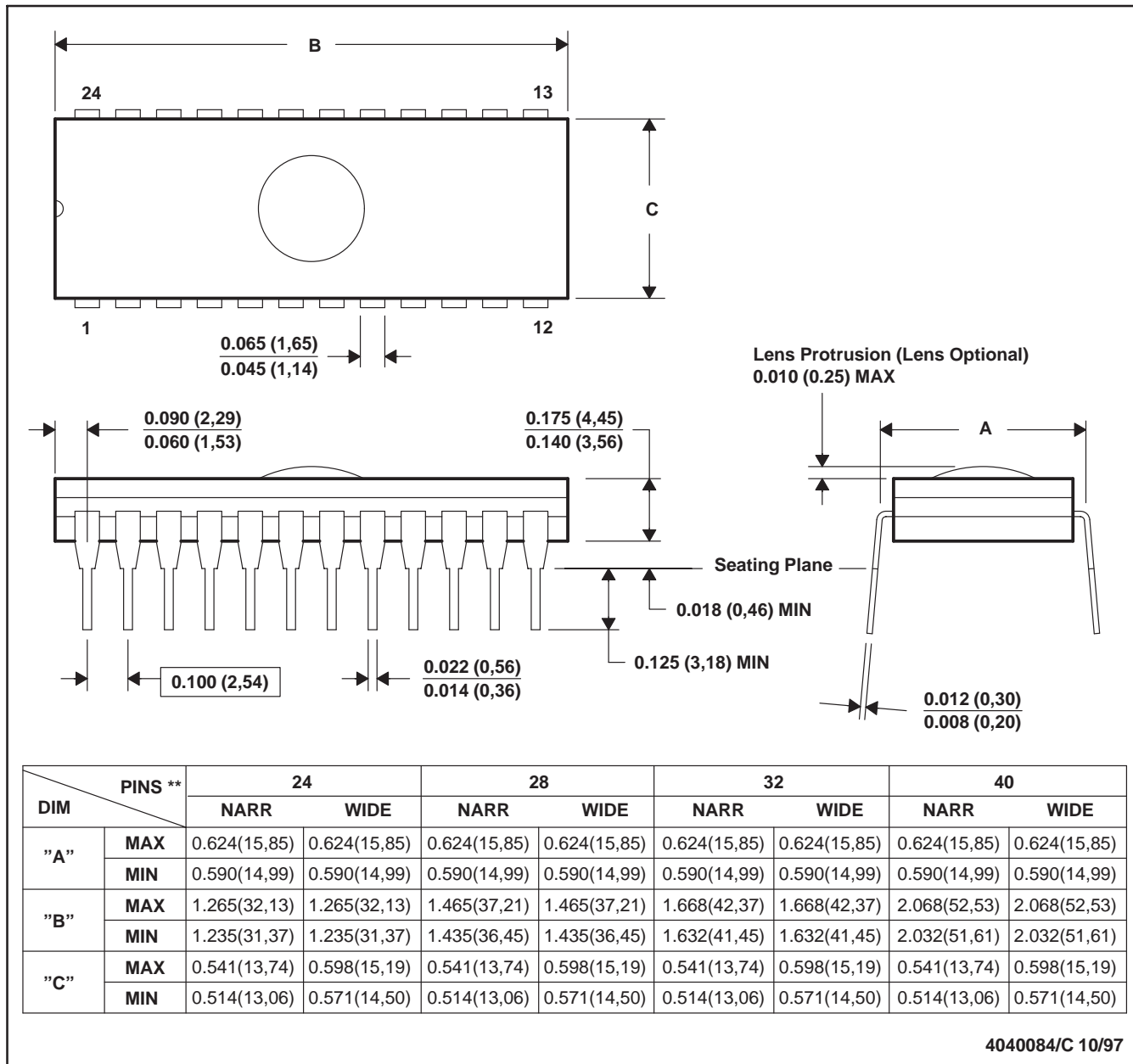

- NOTES:
- A. All linear dimensions are in inches (millimeters).
 - B. This drawing is subject to change without notice.
 - C. Window (lens) added to this group of packages (24-, 28-, 32-, 40-pin).
 - D. This package can be hermetically sealed with a ceramic lid using glass frit.
 - E. Index point is provided on cap for terminal identification.

J (R-GDIP-T**)

14 LEADS SHOWN

CERAMIC DUAL IN-LINE PACKAGE



DIM \ PINS **	14	16	18	20
A	0.300 (7,62) BSC	0.300 (7,62) BSC	0.300 (7,62) BSC	0.300 (7,62) BSC
B MAX	0.785 (19,94)	.840 (21,34)	0.960 (24,38)	1.060 (26,92)
B MIN	—	—	—	—
C MAX	0.300 (7,62)	0.300 (7,62)	0.310 (7,87)	0.300 (7,62)
C MIN	0.245 (6,22)	0.245 (6,22)	0.220 (5,59)	0.245 (6,22)



4040083/F 03/03

- NOTES:
- All linear dimensions are in inches (millimeters).
 - This drawing is subject to change without notice.
 - This package is hermetically sealed with a ceramic lid using glass frit.
 - Index point is provided on cap for terminal identification only on press ceramic glass frit seal only.
 - Falls within MIL STD 1835 GDIP1-T14, GDIP1-T16, GDIP1-T18 and GDIP1-T20.

W (R-GDFP-F16)

CERAMIC DUAL FLATPACK



- NOTES:
- A. All linear dimensions are in inches (millimeters).
 - B. This drawing is subject to change without notice.
 - C. This package can be hermetically sealed with a ceramic lid using glass frit.
 - D. Index point is provided on cap for terminal identification only.
 - E. Falls within MIL STD 1835 GDFP1-F16 and JEDEC MO-092AC

W (R-GDFP-F24)

CERAMIC DUAL FLATPACK

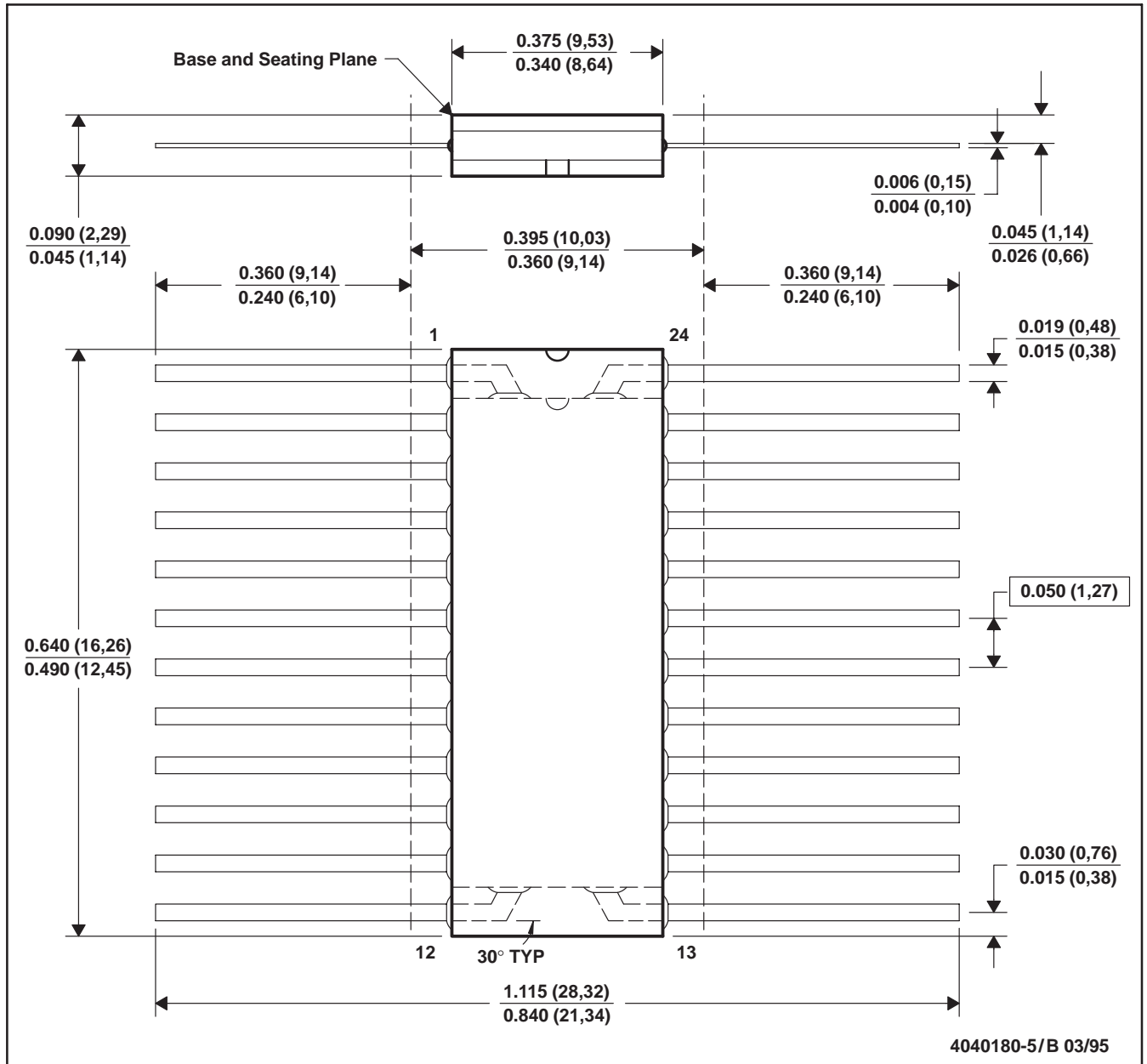

- NOTES:
- All linear dimensions are in inches (millimeters).
 - This drawing is subject to change without notice.
 - This package can be hermetically sealed with a ceramic lid using glass frit.
 - Falls within MIL-STD-1835 GDFP2-F24 and JEDEC MO-070AD
 - Index point is provided on cap for terminal identification only.

FK (S-CQCC-N**)

LEADLESS CERAMIC CHIP CARRIER

28 TERMINAL SHOWN



NO. OF TERMINALS **	A		B	
	MIN	MAX	MIN	MAX
20	0.342 (8,69)	0.358 (9,09)	0.307 (7,80)	0.358 (9,09)
28	0.442 (11,23)	0.458 (11,63)	0.406 (10,31)	0.458 (11,63)
44	0.640 (16,26)	0.660 (16,76)	0.495 (12,58)	0.560 (14,22)
52	0.740 (18,78)	0.761 (19,32)	0.495 (12,58)	0.560 (14,22)
68	0.938 (23,83)	0.962 (24,43)	0.850 (21,6)	0.858 (21,8)
84	1.141 (28,99)	1.165 (29,59)	1.047 (26,6)	1.063 (27,0)



4040140/D 01/11

- NOTES:
- All linear dimensions are in inches (millimeters).
 - This drawing is subject to change without notice.
 - This package can be hermetically sealed with a metal lid.
 - Falls within JEDEC MS-004

N (R-PDIP-T**)

PLASTIC DUAL-IN-LINE PACKAGE

16 PINS SHOWN



- NOTES:
- A. All linear dimensions are in inches (millimeters).
 - B. This drawing is subject to change without notice.
 - C. Falls within JEDEC MS-001, except 18 and 20 pin minimum body length (Dim A).
 - D. The 20 pin end lead shoulder width is a vendor option, either half or full width.

N (R-PDIP-T24)

PLASTIC DUAL-IN-LINE

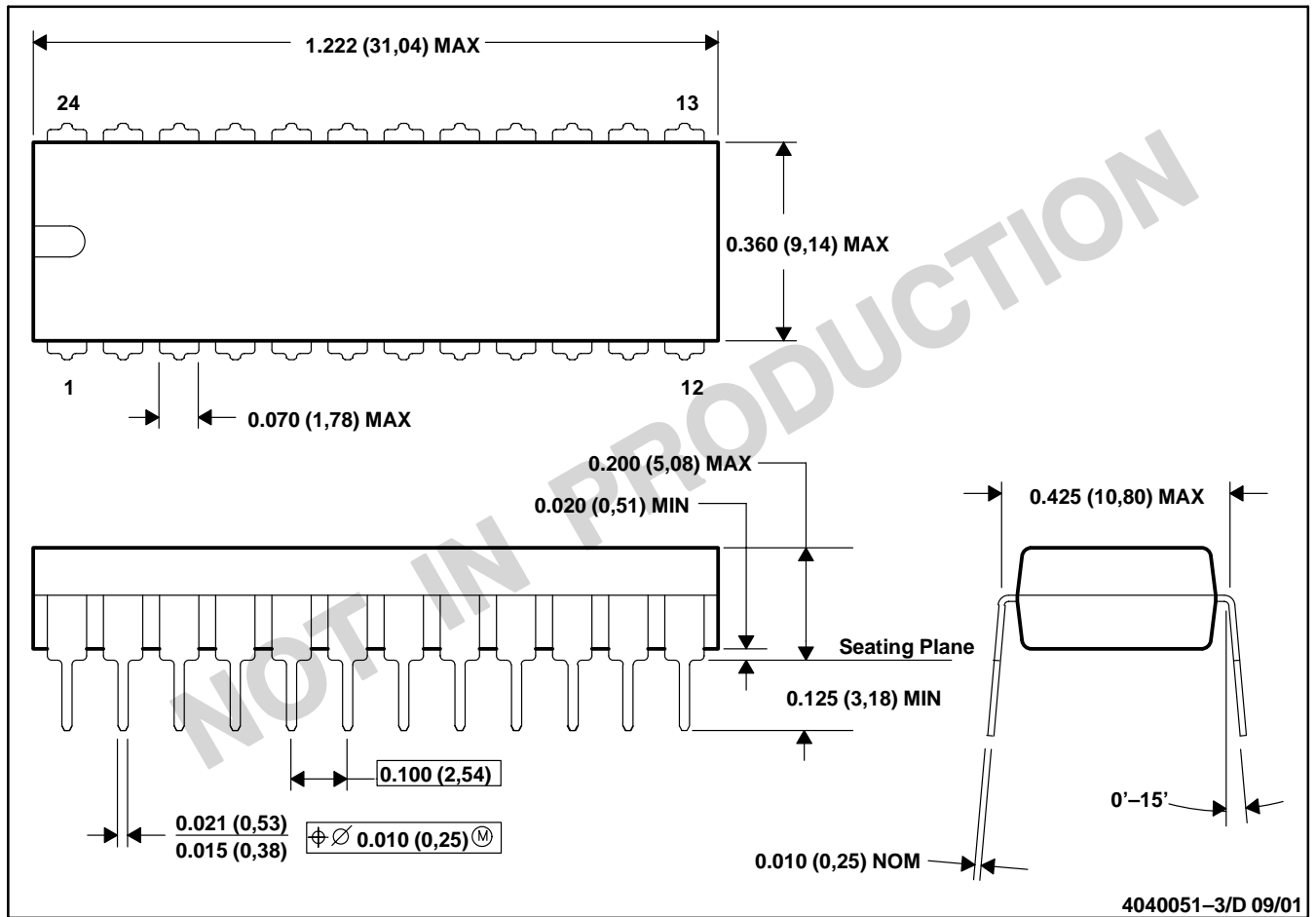

- NOTES: A. All linear dimensions are in inches (millimeters).
 B. This drawing is subject to change without notice.
 C. Falls within JEDEC MS-010

N (R-PDIP-T)**

PLASTIC DUAL-IN-LINE PACKAGE

24 PIN SHOWN



- NOTES: A. All linear dimensions are in inches (millimeters).
 B. This drawing is subject to change without notice.
 C. Falls within JEDEC MS-011
 D. Falls within JEDEC MS-015 (32 pin only)

D (R-PDSO-G16)

PLASTIC SMALL OUTLINE



- NOTES:
- A. All linear dimensions are in inches (millimeters).
 - B. This drawing is subject to change without notice.
 - C. Body length does not include mold flash, protrusions, or gate burrs. Mold flash, protrusions, or gate burrs shall not exceed 0.006 (0,15) each side.
 - D. Body width does not include interlead flash. Interlead flash shall not exceed 0.017 (0,43) each side.
 - E. Reference JEDEC MS-012 variation AC.

D (R-PDSO-G16)

PLASTIC SMALL OUTLINE

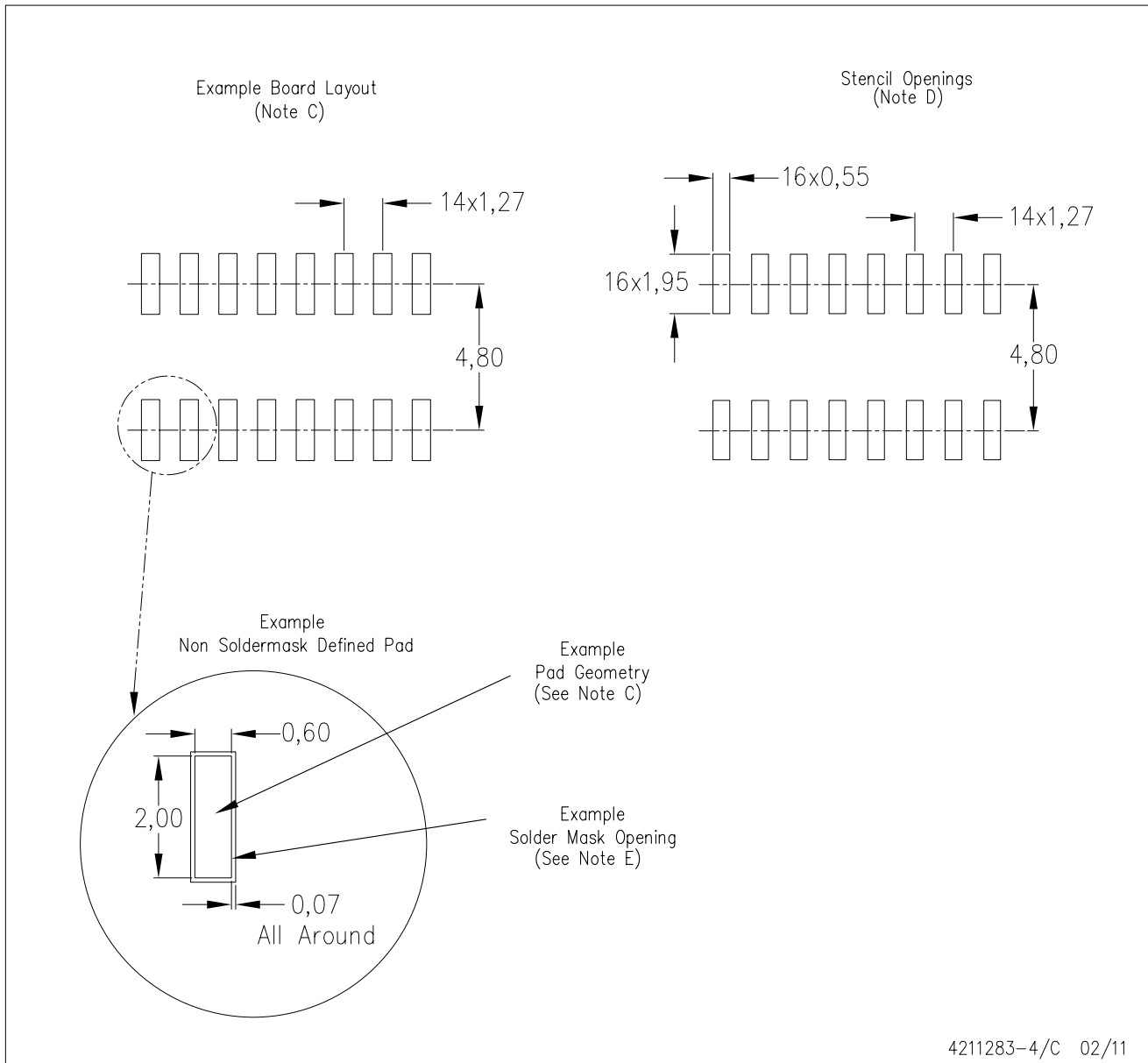

4211283-4/C 02/11

- NOTES:
- All linear dimensions are in millimeters.
 - This drawing is subject to change without notice.
 - Publication IPC-7351 is recommended for alternate designs.
 - Laser cutting apertures with trapezoidal walls and also rounding corners will offer better paste release. Customers should contact their board assembly site for stencil design recommendations. Refer to IPC-7525 for other stencil recommendations.
 - Customers should contact their board fabrication site for solder mask tolerances between and around signal pads.

MECHANICAL DATA

NS (R-PDSO-G**)

PLASTIC SMALL-OUTLINE PACKAGE

14-PINS SHOWN



- NOTES:
- A. All linear dimensions are in millimeters.
 - B. This drawing is subject to change without notice.
 - C. Body dimensions do not include mold flash or protrusion, not to exceed 0,15.

IMPORTANT NOTICE

Texas Instruments Incorporated and its subsidiaries (TI) reserve the right to make corrections, modifications, enhancements, improvements, and other changes to its products and services at any time and to discontinue any product or service without notice. Customers should obtain the latest relevant information before placing orders and should verify that such information is current and complete. All products are sold subject to TI's terms and conditions of sale supplied at the time of order acknowledgment.

TI warrants performance of its hardware products to the specifications applicable at the time of sale in accordance with TI's standard warranty. Testing and other quality control techniques are used to the extent TI deems necessary to support this warranty. Except where mandated by government requirements, testing of all parameters of each product is not necessarily performed.

TI assumes no liability for applications assistance or customer product design. Customers are responsible for their products and applications using TI components. To minimize the risks associated with customer products and applications, customers should provide adequate design and operating safeguards.

TI does not warrant or represent that any license, either express or implied, is granted under any TI patent right, copyright, mask work right, or other TI intellectual property right relating to any combination, machine, or process in which TI products or services are used. Information published by TI regarding third-party products or services does not constitute a license from TI to use such products or services or a warranty or endorsement thereof. Use of such information may require a license from a third party under the patents or other intellectual property of the third party, or a license from TI under the patents or other intellectual property of TI.

Reproduction of TI information in TI data books or data sheets is permissible only if reproduction is without alteration and is accompanied by all associated warranties, conditions, limitations, and notices. Reproduction of this information with alteration is an unfair and deceptive business practice. TI is not responsible or liable for such altered documentation. Information of third parties may be subject to additional restrictions.

Resale of TI products or services with statements different from or beyond the parameters stated by TI for that product or service voids all express and any implied warranties for the associated TI product or service and is an unfair and deceptive business practice. TI is not responsible or liable for any such statements.

TI products are not authorized for use in safety-critical applications (such as life support) where a failure of the TI product would reasonably be expected to cause severe personal injury or death, unless officers of the parties have executed an agreement specifically governing such use. Buyers represent that they have all necessary expertise in the safety and regulatory ramifications of their applications, and acknowledge and agree that they are solely responsible for all legal, regulatory and safety-related requirements concerning their products and any use of TI products in such safety-critical applications, notwithstanding any applications-related information or support that may be provided by TI. Further, Buyers must fully indemnify TI and its representatives against any damages arising out of the use of TI products in such safety-critical applications.

TI products are neither designed nor intended for use in military/aerospace applications or environments unless the TI products are specifically designated by TI as military-grade or "enhanced plastic." Only products designated by TI as military-grade meet military specifications. Buyers acknowledge and agree that any such use of TI products which TI has not designated as military-grade is solely at the Buyer's risk, and that they are solely responsible for compliance with all legal and regulatory requirements in connection with such use.

TI products are neither designed nor intended for use in automotive applications or environments unless the specific TI products are designated by TI as compliant with ISO/TS 16949 requirements. Buyers acknowledge and agree that, if they use any non-designated products in automotive applications, TI will not be responsible for any failure to meet such requirements.

Following are URLs where you can obtain information on other Texas Instruments products and application solutions:

Products

Audio	www.ti.com/audio
Amplifiers	amplifier.ti.com
Data Converters	dataconverter.ti.com
DLP® Products	www.dlp.com
DSP	dsp.ti.com
Clocks and Timers	www.ti.com/clocks
Interface	interface.ti.com
Logic	logic.ti.com
Power Mgmt	power.ti.com
Microcontrollers	microcontroller.ti.com
RFID	www.ti-rfid.com
RF/IF and ZigBee® Solutions	www.ti.com/lprf

Applications

Communications and Telecom	www.ti.com/communications
Computers and Peripherals	www.ti.com/computers
Consumer Electronics	www.ti.com/consumer-apps
Energy and Lighting	www.ti.com/energy
Industrial	www.ti.com/industrial
Medical	www.ti.com/medical
Security	www.ti.com/security
Space, Avionics and Defense	www.ti.com/space-avionics-defense
Transportation and Automotive	www.ti.com/automotive
Video and Imaging	www.ti.com/video
Wireless	www.ti.com/wireless-apps

TI E2E Community Home Page

e2e.ti.com

Mailing Address: Texas Instruments, Post Office Box 655303, Dallas, Texas 75265
Copyright © 2011, Texas Instruments Incorporated