

Ultra High Frequency Transistor Arrays

The HFA3046, HFA3096, HFA3127 and the HFA3128 are Ultra High Frequency Transistor Arrays that are fabricated from Intersil Corporation’s complementary bipolar UHF-1 process. Each array consists of five dielectrically isolated transistors on a common monolithic substrate. The NPN transistors exhibit a f_T of 8GHz while the PNP transistors provide a f_T of 5.5GHz. Both types exhibit low noise (3.5dB), making them ideal for high frequency amplifier and mixer applications.

The HFA3046 and HFA3127 are all NPN arrays while the HFA3128 has all PNP transistors. The HFA3096 is an NPN-PNP combination. Access is provided to each of the terminals for the individual transistors for maximum application flexibility. Monolithic construction of these transistor arrays provides close electrical and thermal matching of the five transistors.

Intersil provides an Application Note illustrating the use of these devices as RF amplifiers. For more information, visit our website at www.intersil.com.

Features

- NPN Transistor (f_T) 8GHz
- NPN Current Gain (h_{FE}). 130
- NPN Early Voltage (V_A) 50V
- PNP Transistor (f_T). 5.5GHz
- PNP Current Gain (h_{FE}). 60
- PNP Early Voltage (V_A) 20V
- Noise Figure (50 Ω) at 1.0GHz 3.5dB
- Collector to Collector Leakage <1pA
- Complete Isolation Between Transistors
- Pin Compatible with Industry Standard 3XXX Series Arrays
- Pb-Free (RoHS Compliant)

Applications

- VHF/UHF Amplifiers
- VHF/UHF Mixers
- IF Converters
- Synchronous Detectors

Ordering Information

PART NUMBER* (Note)	PART MARKING	TEMP. RANGE (°C)	PACKAGE (PB-free)	PKG. DWG. #
HFA3046BZ	HFA3046BZ	-55 to +125	14 Ld SOIC	M14.15
HFA3096BZ	HFA3096BZ	-55 to +125	16 Ld SOIC	M16.15
HFA3127BZ	HFA3127BZ	-55 to +125	16 Ld SOIC	M16.15
HFA3127RZ	127Z	-55 to +125	16 Ld 3x3 QFN	L16.3x3
HFA3128BZ	HFA3128BZ	-55 to +125	16 Ld SOIC	M16.15
HFA3128RZ	128Z	-55 to +125	16 Ld 3x3 QFN	L16.3x3

*Add “96” suffix for tape and reel.

NOTE: These Intersil Pb-free plastic packaged products employ special Pb-free material sets, molding compounds/die attach materials, and 100% matte tin plate plus anneal (e3 termination finish, which is RoHS compliant and compatible with both SnPb and Pb-free soldering operations). Intersil Pb-free products are MSL classified at Pb-free peak reflow temperatures that meet or exceed the Pb-free requirements of IPC/JEDEC J STD-020.

Pinouts

HFA3046
(14 LD SOIC)
TOP VIEW

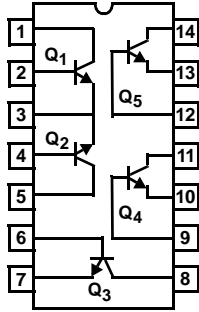

HFA3096
(16 LD SOIC)
TOP VIEW

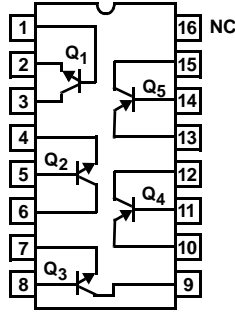

HFA3127
(16 LD SOIC)
TOP VIEW

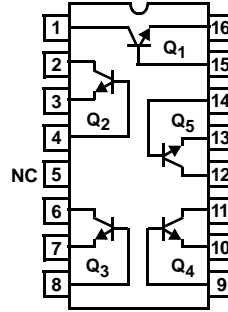

HFA3128
(16 LD SOIC)
TOP VIEW

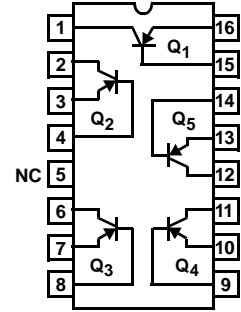

HFA3127, HFA3128
(16 LD 3X3 QFN)
TOP VIEW

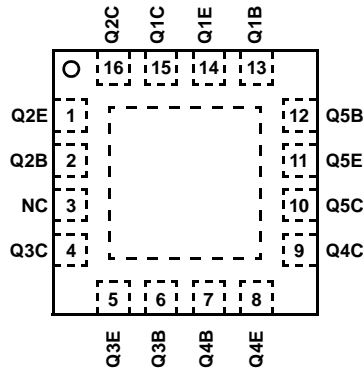

HFA3046, HFA3096, HFA3127, HFA3128

Absolute Maximum Ratings

Collector to Emitter Voltage (Open Base)	8V
Collector to Base Voltage (Open Emitter)	12V
Emitter to Base Voltage (Reverse Bias).....	5.5V
Collector Current (100% Duty Cycle)	18.5mA at T _J = +150°C
	34mA at T _J = +125°C
	37mA at T _J = +110°C
Peak Collector Current (Any Condition).....	65mA

Thermal Information

Thermal Resistance (Typical)	θ _{JA} (°C/W)	θ _{JC} (°C/W)
14 Ld SOIC Package (Note 1)	120	N/A
16 Ld SOIC Package (Note 1)	115	N/A
QFN Package (Notes 2, 3).....	57	10
Maximum Power Dissipation (Any One Transistor)	0.15W	
Maximum Junction Temperature (Die)	+175°C	
Maximum Junction Temperature (Plastic Package)	+150°C	
Maximum Storage Temperature	-65°C to +150°C	
Pb-Free Reflow Profile see link below		
http://www.intersil.com/pbfree/Pb-FreeReflow.asp		

Operating Information

Temperature Range

CAUTION: Stresses above those listed in "Absolute Maximum Ratings" may cause permanent damage to the device. This is a stress only rating and operation of the device at these or any other conditions above those indicated in the operational sections of this specification is not implied.

NOTES:

1. θ_{JA} is measured with the component mounted on an evaluation PC board in free air.
2. For θ_{JC}, the "case temp" location is the center of the exposed metal pad on the package underside.
3. θ_{JA} is measured with the component mounted on a high effective thermal conductivity test board in free air. See Tech Brief [TB379](#) for details.

Electrical Specifications T_A = +25°C

PARAMETER	TEST CONDITIONS	DIE			SOIC, QFN			UNITS
		MIN	TYP	MAX	MIN	TYP	MAX	
DC NPN CHARACTERISTICS								
Collector to Base Breakdown Voltage, V _{(BR)CBO}	I _C = 100μA, I _E = 0	12	18	-	12	18	-	V
Collector to Emitter Breakdown Voltage, V _{(BR)CEO}	I _C = 100μA, I _B = 0	8	12	-	8	12	-	V
Collector to Emitter Breakdown Voltage, V _{(BR)CES}	I _C = 100μA, Base Shorted to Emitter	10	20	-	10	20	-	V
Emitter to Base Breakdown Voltage, V _{(BR)EBO}	I _E = 10μA, I _C = 0	5.5	6	-	5.5	6	-	V
Collector-Cutoff-Current, I _{CEO}	V _{CE} = 6V, I _B = 0	-	2	100	-	2	100	nA
Collector-Cutoff-Current, I _{CBO}	V _{CB} = 8V, I _E = 0	-	0.1	10	-	0.1	10	nA
Collector to Emitter Saturation Voltage, V _{CE(SAT)}	I _C = 10mA, I _B = 1mA	-	0.3	0.5	-	0.3	0.5	V
Base to Emitter Voltage, V _{BE}	I _C = 10mA	-	0.85	0.95	-	0.85	0.95	V
DC Forward-Current Transfer Ratio, h _{FE}	I _C = 10mA, V _{CE} = 2V	40	130	-	40	130	-	
Early Voltage, V _A	I _C = 1mA, V _{CE} = 3.5V	20	50	-	20	50	-	V
Base to Emitter Voltage Drift	I _C = 10mA	-	-1.5	-	-	-1.5	-	mV/°C
Collector to Collector Leakage		-	1	-	-	1	-	pA

Electrical Specifications T_A = +25°C

PARAMETER	TEST CONDITIONS	DIE			SOIC, QFN			UNITS
		MIN	TYP	MAX	MIN	TYP	MAX	
DYNAMIC NPN CHARACTERISTICS								
Noise Figure	f = 1.0GHz, V _{CE} = 5V, I _C = 5mA, Z _S = 50Ω	-	3.5	-	-	3.5	-	dB
f _T Current Gain-Bandwidth Product	I _C = 1mA, V _{CE} = 5V	-	5.5	-	-	5.5	-	GHz
	I _C = 10mA, V _{CE} = 5V	-	8	-	-	8	-	GHz

HFA3046, HFA3096, HFA3127, HFA3128

Electrical Specifications $T_A = +25^\circ\text{C}$ (Continued)

PARAMETER	TEST CONDITIONS	DIE			SOIC, QFN			UNITS
		MIN	TYP	MAX	MIN	TYP	MAX	
Power Gain-Bandwidth Product, f_{MAX}	$I_C = 10\text{mA}$, $V_{\text{CE}} = 5\text{V}$	-	6	-	-	2.5	-	GHz
Base to Emitter Capacitance	$V_{\text{BE}} = -3\text{V}$	-	200	-	-	500	-	fF
Collector to Base Capacitance	$V_{\text{CB}} = 3\text{V}$	-	200	-	-	500	-	fF

Electrical Specifications $T_A = +25^\circ\text{C}$

PARAMETER	TEST CONDITIONS	DIE			SOIC, QFN			UNITS
		MIN	TYP	MAX	MIN	TYP	MAX	
DC PNP CHARACTERISTICS								
Collector to Base Breakdown Voltage, $V_{(\text{BR})\text{CBO}}$	$I_C = -100\mu\text{A}$, $I_E = 0$	10	15	-	10	15	-	V
Collector to Emitter Breakdown Voltage, $V_{(\text{BR})\text{CEO}}$	$I_C = -100\mu\text{A}$, $I_B = 0$	8	15	-	8	15	-	V
Collector to Emitter Breakdown Voltage, $V_{(\text{BR})\text{CES}}$	$I_C = -100\mu\text{A}$, Base Shorted to Emitter	10	15	-	10	15	-	V
Emitter to Base Breakdown Voltage, $V_{(\text{BR})\text{EBO}}$	$I_E = -10\mu\text{A}$, $I_C = 0$	4.5	5	-	4.5	5	-	V
Collector Cutoff Current, I_{CEO}	$V_{\text{CE}} = -6\text{V}$, $I_B = 0$	-	2	100	-	2	100	nA
Collector Cutoff Current, I_{CBO}	$V_{\text{CB}} = -8\text{V}$, $I_E = 0$	-	0.1	10	-	0.1	10	nA
Collector to Emitter Saturation Voltage, $V_{\text{CE}(\text{SAT})}$	$I_C = -10\text{mA}$, $I_B = -1\text{mA}$	-	0.3	0.5	-	0.3	0.5	V
Base to Emitter Voltage, V_{BE}	$I_C = -10\text{mA}$	-	0.85	0.95	-	0.85	0.95	V
DC Forward-Current Transfer Ratio, h_{FE}	$I_C = -10\text{mA}$, $V_{\text{CE}} = -2\text{V}$	20	60	-	20	60	-	
Early Voltage, V_A	$I_C = -1\text{mA}$, $V_{\text{CE}} = -3.5\text{V}$	10	20	-	10	20	-	V
Base to Emitter Voltage Drift	$I_C = -10\text{mA}$	-	-1.5	-	-	-1.5	-	mV/ $^\circ\text{C}$
Collector to Collector Leakage		-	1	-	-	1	-	pA

Electrical Specifications $T_A = +25^\circ\text{C}$

PARAMETER	TEST CONDITIONS	DIE			SOIC, QFN			UNITS
		MIN	TYP	MAX	MIN	TYP	MAX	
DYNAMIC PNP CHARACTERISTICS								
Noise Figure	$f = 1.0\text{GHz}$, $V_{\text{CE}} = -5\text{V}$, $I_C = -5\text{mA}$, $Z_S = 50\Omega$	-	3.5	-	-	3.5	-	dB
f_T Current Gain-Bandwidth Product	$I_C = -1\text{mA}$, $V_{\text{CE}} = -5\text{V}$	-	2	-	-	2	-	GHz
	$I_C = -10\text{mA}$, $V_{\text{CE}} = -5\text{V}$	-	5.5	-	-	5.5	-	GHz
Power Gain-Bandwidth Product	$I_C = -10\text{mA}$, $V_{\text{CE}} = -5\text{V}$	-	3	-	-	2	-	GHz
Base to Emitter Capacitance	$V_{\text{BE}} = 3\text{V}$	-	200	-	-	500	-	fF
Collector to Base Capacitance	$V_{\text{CB}} = -3\text{V}$	-	300	-	-	600	-	fF

HFA3046, HFA3096, HFA3127, HFA3128

Electrical Specifications $T_A = +25^\circ\text{C}$ (Continued)

PARAMETER	TEST CONDITIONS	DIE			SOIC, QFN			UNITS
		MIN	TYP	MAX	MIN	TYP	MAX	
DIFFERENTIAL PAIR MATCHING CHARACTERISTICS FOR THE HFA3046								
Input Offset Voltage	$I_C = 10\text{mA}$, $V_{CE} = 5\text{V}$	-	1.5	5.0	-	1.5	5.0	mV
Input Offset Current	$I_C = 10\text{mA}$, $V_{CE} = 5\text{V}$	-	5	25	-	5	25	μA
Input Offset Voltage TC	$I_C = 10\text{mA}$, $V_{CE} = 5\text{V}$	-	0.5	-	-	0.5	-	$\mu\text{V}/^\circ\text{C}$

S-Parameter and PSPICE model data is available from Intersil Sales Offices, and Intersil Corporation's web site.

Common Emitter S-Parameters of NPN $3\mu\text{m} \times 50\mu\text{m}$ Transistor

FREQ. (Hz)	$ S_{11} $	PHASE(S_{11})	$ S_{21} $	PHASE(S_{21})	$ S_{12} $	PHASE(S_{12})	$ S_{22} $	PHASE(S_{22})
$V_{CE} = 5\text{V}$ and $I_C = 5\text{mA}$								
1.0E+08	0.83	-11.78	11.07	168.57	1.41E-02	78.88	0.97	-11.05
2.0E+08	0.79	-22.82	10.51	157.89	2.69E-02	68.63	0.93	-21.35
3.0E+08	0.73	-32.64	9.75	148.44	3.75E-02	59.58	0.86	-30.44
4.0E+08	0.67	-41.08	8.91	140.36	4.57E-02	51.90	0.79	-38.16
5.0E+08	0.61	-48.23	8.10	133.56	5.19E-02	45.50	0.73	-44.59
6.0E+08	0.55	-54.27	7.35	127.88	5.65E-02	40.21	0.67	-49.93
7.0E+08	0.50	-59.41	6.69	123.10	6.00E-02	35.82	0.62	-54.37
8.0E+08	0.46	-63.81	6.11	119.04	6.27E-02	32.15	0.57	-58.10
9.0E+08	0.42	-67.63	5.61	115.57	6.47E-02	29.07	0.53	-61.25
1.0E+09	0.39	-70.98	5.17	112.55	6.63E-02	26.45	0.50	-63.96
1.1E+09	0.36	-73.95	4.79	109.91	6.75E-02	24.19	0.47	-66.31
1.2E+09	0.34	-76.62	4.45	107.57	6.85E-02	22.24	0.45	-68.37
1.3E+09	0.32	-79.04	4.15	105.47	6.93E-02	20.53	0.43	-70.19
1.4E+09	0.30	-81.25	3.89	103.57	7.00E-02	19.02	0.41	-71.83
1.5E+09	0.28	-83.28	3.66	101.84	7.05E-02	17.69	0.40	-73.31
1.6E+09	0.27	-85.17	3.45	100.26	7.10E-02	16.49	0.39	-74.66
1.7E+09	0.25	-86.92	3.27	98.79	7.13E-02	15.41	0.38	-75.90
1.8E+09	0.24	-88.57	3.10	97.43	7.17E-02	14.43	0.37	-77.05
1.9E+09	0.23	-90.12	2.94	96.15	7.19E-02	13.54	0.36	-78.12
2.0E+09	0.22	-91.59	2.80	94.95	7.21E-02	12.73	0.35	-79.13
2.1E+09	0.21	-92.98	2.68	93.81	7.23E-02	11.98	0.35	-80.09
2.2E+09	0.20	-94.30	2.56	92.73	7.25E-02	11.29	0.34	-80.99
2.3E+09	0.20	-95.57	2.45	91.70	7.27E-02	10.64	0.34	-81.85
2.4E+09	0.19	-96.78	2.35	90.72	7.28E-02	10.05	0.33	-82.68
2.5E+09	0.18	-97.93	2.26	89.78	7.29E-02	9.49	0.33	-83.47
2.6E+09	0.18	-99.05	2.18	88.87	7.30E-02	8.96	0.33	-84.23
2.7E+09	0.17	-100.12	2.10	88.00	7.31E-02	8.47	0.33	-84.97
2.8E+09	0.17	-101.15	2.02	87.15	7.31E-02	8.01	0.33	-85.68
2.9E+09	0.16	-102.15	1.96	86.33	7.32E-02	7.57	0.33	-86.37
3.0E+09	0.16	-103.11	1.89	85.54	7.32E-02	7.16	0.33	-87.05

Common Emitter S-Parameters of NPN 3 μ m x 50 μ m Transistor (Continued)

FREQ. (Hz)	S ₁₁	PHASE(S ₁₁)	S ₂₁	PHASE(S ₂₁)	S ₁₂	PHASE(S ₁₂)	S ₂₂	PHASE(S ₂₂)
V_{CE} = 5V and I_C = 10mA								
1.0E+08	0.72	-16.43	15.12	165.22	1.27E-02	75.41	0.95	-14.26
2.0E+08	0.67	-31.26	13.90	152.04	2.34E-02	62.89	0.88	-26.95
3.0E+08	0.60	-43.76	12.39	141.18	3.13E-02	52.58	0.79	-37.31
4.0E+08	0.53	-54.00	10.92	132.57	3.68E-02	44.50	0.70	-45.45
5.0E+08	0.47	-62.38	9.62	125.78	4.05E-02	38.23	0.63	-51.77
6.0E+08	0.42	-69.35	8.53	120.37	4.31E-02	33.34	0.57	-56.72
7.0E+08	0.37	-75.26	7.62	116.00	4.49E-02	29.47	0.51	-60.65
8.0E+08	0.34	-80.36	6.86	112.39	4.63E-02	26.37	0.47	-63.85
9.0E+08	0.31	-84.84	6.22	109.36	4.72E-02	23.84	0.44	-66.49
1.0E+09	0.29	-88.83	5.69	106.77	4.80E-02	21.75	0.41	-68.71
1.1E+09	0.27	-92.44	5.23	104.51	4.86E-02	20.00	0.39	-70.62
1.2E+09	0.25	-95.73	4.83	102.53	4.90E-02	18.52	0.37	-72.28
1.3E+09	0.24	-98.75	4.49	100.75	4.94E-02	17.25	0.35	-73.76
1.4E+09	0.22	-101.55	4.19	99.16	4.97E-02	16.15	0.34	-75.08
1.5E+09	0.21	-104.15	3.93	97.70	4.99E-02	15.19	0.33	-76.28
1.6E+09	0.20	-106.57	3.70	96.36	5.01E-02	14.34	0.32	-77.38
1.7E+09	0.20	-108.85	3.49	95.12	5.03E-02	13.60	0.31	-78.41
1.8E+09	0.19	-110.98	3.30	93.96	5.05E-02	12.94	0.31	-79.37
1.9E+09	0.18	-113.00	3.13	92.87	5.06E-02	12.34	0.30	-80.27
2.0E+09	0.18	-114.90	2.98	91.85	5.07E-02	11.81	0.30	-81.13
2.1E+09	0.17	-116.69	2.84	90.87	5.08E-02	11.33	0.30	-81.95
2.2E+09	0.17	-118.39	2.72	89.94	5.09E-02	10.89	0.29	-82.74
2.3E+09	0.16	-120.01	2.60	89.06	5.10E-02	10.50	0.29	-83.50
2.4E+09	0.16	-121.54	2.49	88.21	5.11E-02	10.13	0.29	-84.24
2.5E+09	0.16	-122.99	2.39	87.39	5.12E-02	9.80	0.29	-84.95
2.6E+09	0.15	-124.37	2.30	86.60	5.12E-02	9.49	0.29	-85.64
2.7E+09	0.15	-125.69	2.22	85.83	5.13E-02	9.21	0.29	-86.32
2.8E+09	0.15	-126.94	2.14	85.09	5.13E-02	8.95	0.29	-86.98
2.9E+09	0.15	-128.14	2.06	84.36	5.14E-02	8.71	0.29	-87.62
3.0E+09	0.14	-129.27	1.99	83.66	5.15E-02	8.49	0.29	-88.25

Common Emitter S-Parameters of PNP 3 μ m x 50 μ m Transistor

FREQ. (Hz)	S ₁₁	PHASE(S ₁₁)	S ₂₁	PHASE(S ₂₁)	S ₁₂	PHASE(S ₁₂)	S ₂₂	PHASE(S ₂₂)
V_{CE} = -5V and I_C = -5mA								
1.0E+08	0.72	-16.65	10.11	166.77	1.66E-02	77.18	0.96	-10.76
2.0E+08	0.68	-32.12	9.44	154.69	3.10E-02	65.94	0.90	-20.38
3.0E+08	0.62	-45.73	8.57	144.40	4.23E-02	56.39	0.82	-28.25
4.0E+08	0.57	-57.39	7.68	135.95	5.05E-02	48.66	0.74	-34.31
5.0E+08	0.52	-67.32	6.86	129.11	5.64E-02	42.52	0.67	-38.81

Common Emitter S-Parameters of PNP 3 μm x 50 μm Transistor (Continued)

FREQ. (Hz)	S ₁₁	PHASE(S ₁₁)	S ₂₁	PHASE(S ₂₁)	S ₁₂	PHASE(S ₁₂)	S ₂₂	PHASE(S ₂₂)
6.0E+08	0.47	-75.83	6.14	123.55	6.07E-02	37.66	0.61	-42.10
7.0E+08	0.43	-83.18	5.53	118.98	6.37E-02	33.79	0.55	-44.47
8.0E+08	0.40	-89.60	5.01	115.17	6.60E-02	30.67	0.51	-46.15
9.0E+08	0.38	-95.26	4.56	111.94	6.77E-02	28.14	0.47	-47.33
1.0E+09	0.36	-100.29	4.18	109.17	6.91E-02	26.06	0.44	-48.15
1.1E+09	0.34	-104.80	3.86	106.76	7.01E-02	24.33	0.41	-48.69
1.2E+09	0.33	-108.86	3.58	104.63	7.09E-02	22.89	0.39	-49.05
1.3E+09	0.32	-112.53	3.33	102.72	7.16E-02	21.67	0.37	-49.26
1.4E+09	0.30	-115.86	3.12	101.01	7.22E-02	20.64	0.36	-49.38
1.5E+09	0.30	-118.90	2.92	99.44	7.27E-02	19.76	0.34	-49.43
1.6E+09	0.29	-121.69	2.75	98.01	7.32E-02	19.00	0.33	-49.44
1.7E+09	0.28	-124.24	2.60	96.68	7.35E-02	18.35	0.32	-49.43
1.8E+09	0.28	-126.59	2.47	95.44	7.39E-02	17.79	0.31	-49.40
1.9E+09	0.27	-128.76	2.34	94.29	7.42E-02	17.30	0.30	-49.38
2.0E+09	0.27	-130.77	2.23	93.19	7.45E-02	16.88	0.30	-49.36
2.1E+09	0.26	-132.63	2.13	92.16	7.47E-02	16.52	0.29	-49.35
2.2E+09	0.26	-134.35	2.04	91.18	7.50E-02	16.20	0.28	-49.35
2.3E+09	0.26	-135.96	1.95	90.24	7.52E-02	15.92	0.28	-49.38
2.4E+09	0.25	-137.46	1.87	89.34	7.55E-02	15.68	0.28	-49.42
2.5E+09	0.25	-138.86	1.80	88.48	7.57E-02	15.48	0.27	-49.49
2.6E+09	0.25	-140.17	1.73	87.65	7.59E-02	15.30	0.27	-49.56
2.7E+09	0.25	-141.39	1.67	86.85	7.61E-02	15.15	0.26	-49.67
2.8E+09	0.25	-142.54	1.61	86.07	7.63E-02	15.01	0.26	-49.81
2.9E+09	0.24	-143.62	1.56	85.31	7.65E-02	14.90	0.26	-49.96
3.0E+09	0.24	-144.64	1.51	84.58	7.67E-02	14.81	0.26	-50.13
V_{CE} = -5V, I_C = -10mA								
1.0E+08	0.58	-23.24	13.03	163.45	1.43E-02	73.38	0.93	-13.46
2.0E+08	0.53	-44.07	11.75	149.11	2.58E-02	60.43	0.85	-24.76
3.0E+08	0.48	-61.50	10.25	137.78	3.38E-02	50.16	0.74	-33.10
4.0E+08	0.43	-75.73	8.88	129.12	3.90E-02	42.49	0.65	-38.83
5.0E+08	0.40	-87.36	7.72	122.49	4.25E-02	36.81	0.58	-42.63
6.0E+08	0.37	-96.94	6.78	117.33	4.48E-02	32.59	0.51	-45.07
7.0E+08	0.35	-104.92	6.01	113.22	4.64E-02	29.39	0.47	-46.60
8.0E+08	0.33	-111.64	5.39	109.85	4.76E-02	26.94	0.43	-47.49
9.0E+08	0.32	-117.36	4.87	107.05	4.85E-02	25.04	0.40	-47.97
1.0E+09	0.31	-122.27	4.44	104.66	4.92E-02	23.55	0.37	-48.18
1.1E+09	0.30	-126.51	4.07	102.59	4.97E-02	22.37	0.35	-48.20
1.2E+09	0.30	-130.21	3.76	100.76	5.02E-02	21.44	0.33	-48.11

Common Emitter S-Parameters of PNP 3 μm x 50 μm Transistor (Continued)

FREQ. (Hz)	S ₁₁	PHASE(S ₁₁)	S ₂₁	PHASE(S ₂₁)	S ₁₂	PHASE(S ₁₂)	S ₂₂	PHASE(S ₂₂)
1.3E+09	0.29	-133.46	3.49	99.14	5.06E-02	20.70	0.32	-47.95
1.4E+09	0.29	-136.33	3.25	97.67	5.09E-02	20.11	0.31	-47.77
1.5E+09	0.28	-138.89	3.05	96.33	5.12E-02	19.65	0.30	-47.58
1.6E+09	0.28	-141.17	2.87	95.10	5.15E-02	19.29	0.29	-47.39
1.7E+09	0.28	-143.21	2.70	93.96	5.18E-02	19.01	0.28	-47.23
1.8E+09	0.28	-145.06	2.56	92.90	5.21E-02	18.80	0.27	-47.09
1.9E+09	0.27	-146.73	2.43	91.90	5.23E-02	18.65	0.27	-46.98
2.0E+09	0.27	-148.26	2.31	90.95	5.26E-02	18.55	0.26	-46.91
2.1E+09	0.27	-149.65	2.20	90.05	5.28E-02	18.49	0.26	-46.87
2.2E+09	0.27	-150.92	2.10	89.20	5.30E-02	18.46	0.25	-46.87
2.3E+09	0.27	-152.10	2.01	88.37	5.33E-02	18.47	0.25	-46.90
2.4E+09	0.27	-153.18	1.93	87.59	5.35E-02	18.50	0.25	-46.97
2.5E+09	0.27	-154.17	1.86	86.82	5.38E-02	18.55	0.24	-47.07
2.6E+09	0.26	-155.10	1.79	86.09	5.40E-02	18.62	0.24	-47.18
2.7E+09	0.26	-155.96	1.72	85.38	5.42E-02	18.71	0.24	-47.34
2.8E+09	0.26	-156.76	1.66	84.68	5.45E-02	18.80	0.24	-47.55
2.9E+09	0.26	-157.51	1.60	84.01	5.47E-02	18.91	0.24	-47.76
3.0E+09	0.26	-158.21	1.55	83.35	5.50E-02	19.03	0.23	-48.00

Typical Performance Curves

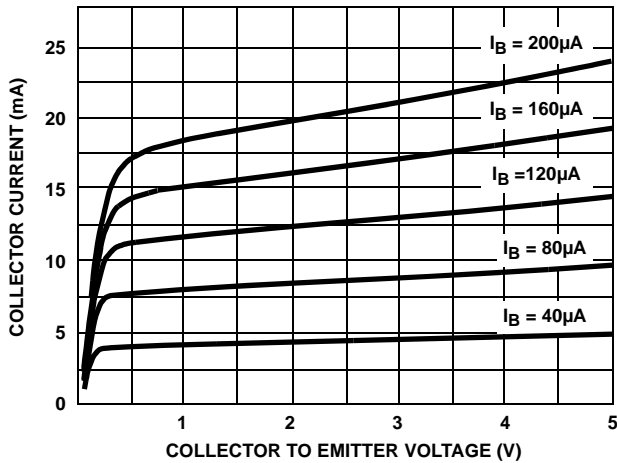

FIGURE 1. NPN COLLECTOR CURRENT vs COLLECTOR TO EMITTER VOLTAGE

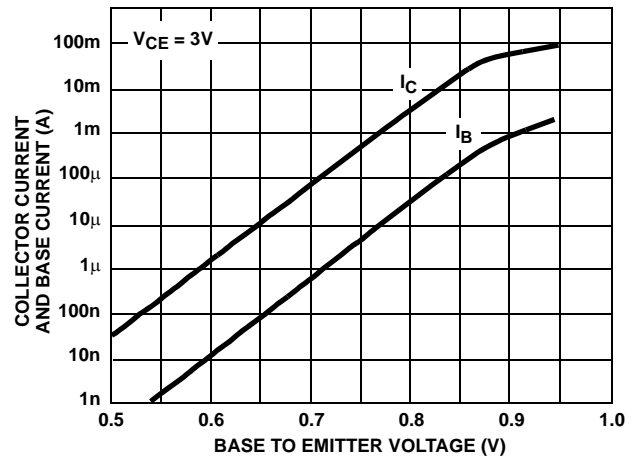

FIGURE 2. NPN COLLECTOR CURRENT AND BASE CURRENT vs BASE TO EMITTER VOLTAGE

Typical Performance Curves (Continued)

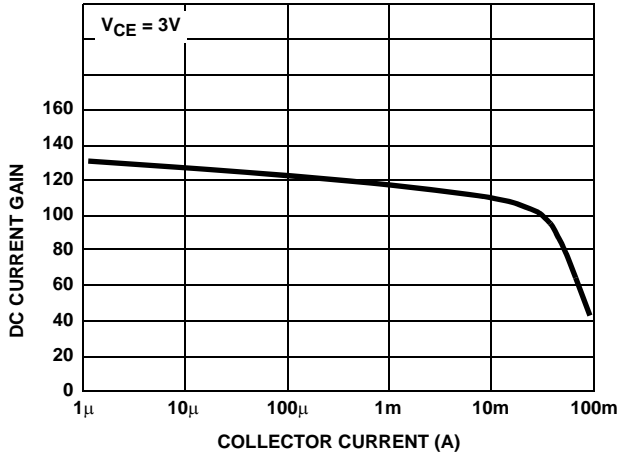

FIGURE 3. NPN DC CURRENT GAIN vs COLLECTOR CURRENT

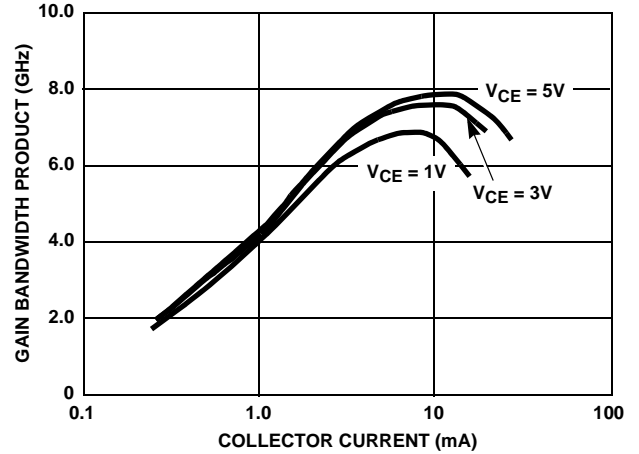

FIGURE 4. NPN GAIN BANDWIDTH PRODUCT vs COLLECTOR CURRENT (UHF 3 x 50 WITH BOND PADS)

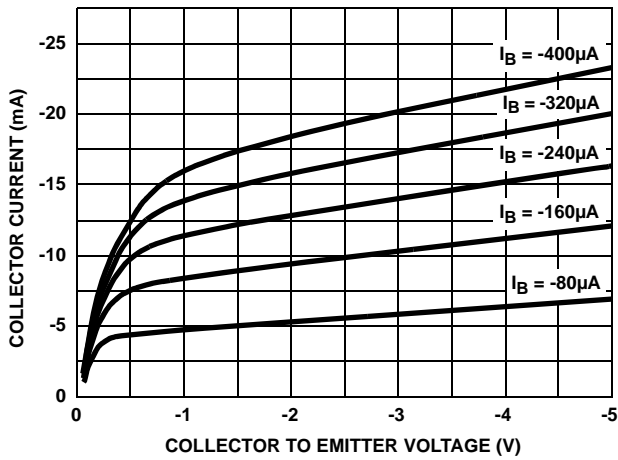

FIGURE 5. PNP COLLECTOR CURRENT vs COLLECTOR TO EMITTER VOLTAGE

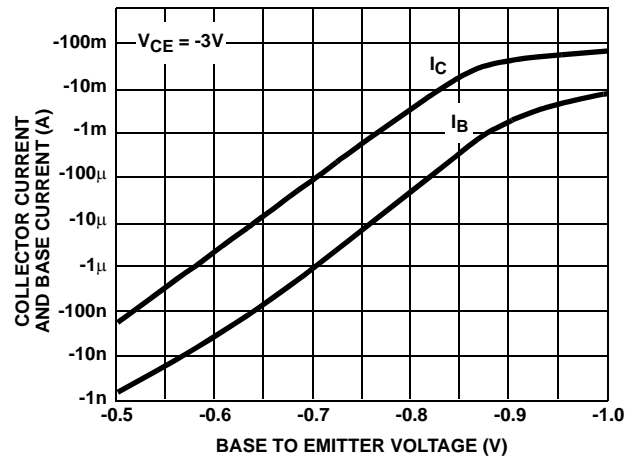

FIGURE 6. PNP COLLECTOR CURRENT AND BASE CURRENT vs BASE TO EMITTER VOLTAGE

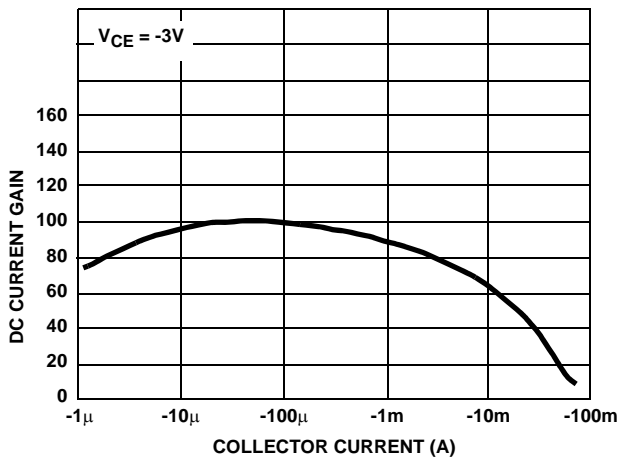

FIGURE 7. PNP DC CURRENT GAIN vs COLLECTOR CURRENT

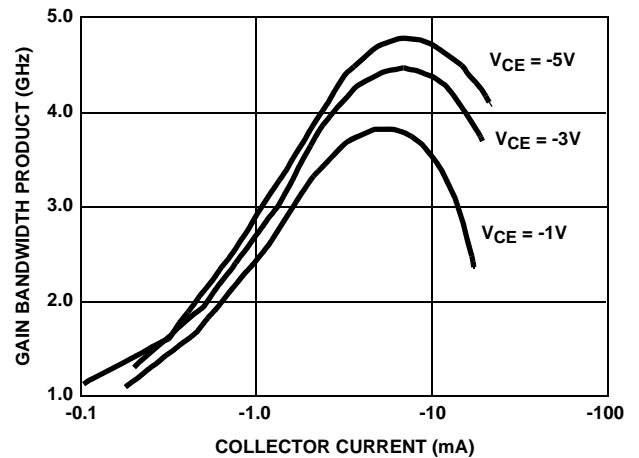

FIGURE 8. PNP GAIN BANDWIDTH PRODUCT vs COLLECTOR CURRENT (UHF 3 x 50 WITH BOND PADS)

Die Characteristics

DIE DIMENSIONS:

53 mils x 52 mils
1340µm x 1320µm

METALLIZATION:

Type: Metal 1: AlCu(2%)/TiW
Thickness: Metal 1: 8kÅ ±0.4kÅ
Type: Metal 2: AlCu(2%)
Thickness: Metal 2: 16kÅ ±0.8kÅ

PASSIVATION:

Type: Nitride
Thickness: 4kÅ ±0.5kÅ

PROCESS:

UHF-1

SUBSTRATE POTENTIAL: (POWERED UP)

Unbiased

Metallization Mask Layout

HFA3096, HFA3127, HFA3128

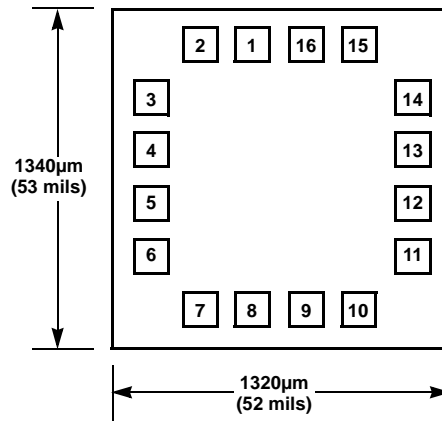

HFA3046

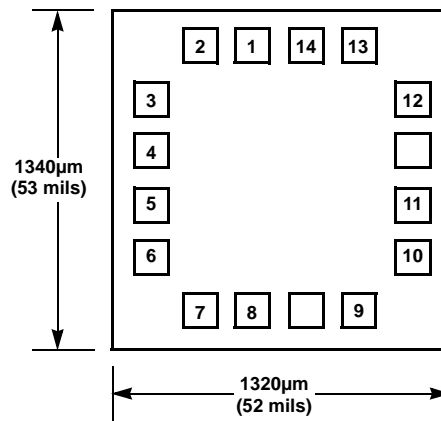

Pad numbers correspond to SOIC pinout.

All Intersil U.S. products are manufactured, assembled and tested utilizing ISO9000 quality systems. Intersil Corporation's quality certifications can be viewed at www.intersil.com/design/quality

Intersil products are sold by description only. Intersil Corporation reserves the right to make changes in circuit design, software and/or specifications at any time without notice. Accordingly, the reader is cautioned to verify that data sheets are current before placing orders. Information furnished by Intersil is believed to be accurate and reliable. However, no responsibility is assumed by Intersil or its subsidiaries for its use; nor for any infringements of patents or other rights of third parties which may result from its use. No license is granted by implication or otherwise under any patent or patent rights of Intersil or its subsidiaries.

For information regarding Intersil Corporation and its products, see www.intersil.com

Package Outline Drawing

M14.15

14 LEAD NARROW BODY SMALL OUTLINE PLASTIC PACKAGE

Rev 1, 10/09

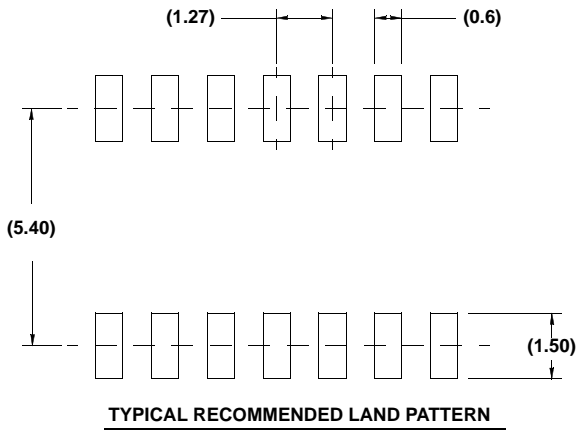
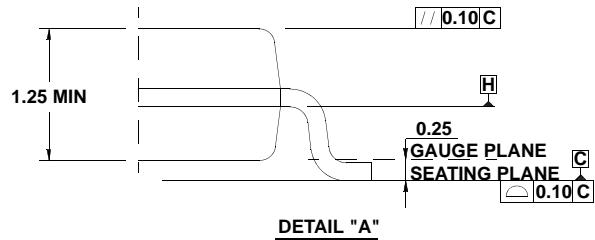
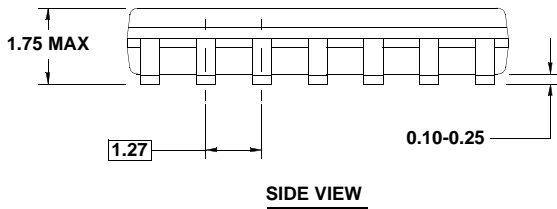
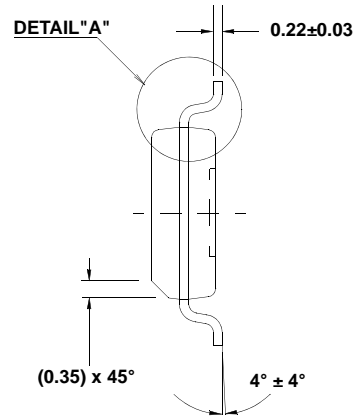
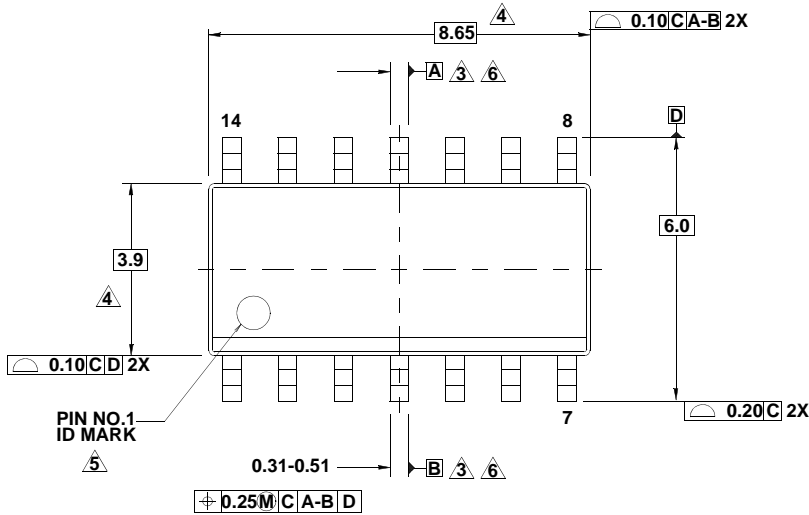

NOTES:

1. Dimensions are in millimeters. Dimensions in () for Reference Only.
2. Dimensioning and tolerancing conform to AMSEY14.5m-1994.
3. Datums A and B to be determined at Datum H.
4. Dimension does not include interlead flash or protrusions. Interlead flash or protrusions shall not exceed 0.25mm per side.
5. The pin #1 identifier may be either a mold or mark feature.
6. Does not include dambar protrusion. Allowable dambar protrusion shall be 0.10mm total in excess of lead width at maximum condition.
7. Reference to JEDEC MS-012-AB.

Small Outline Plastic Packages (SOIC)

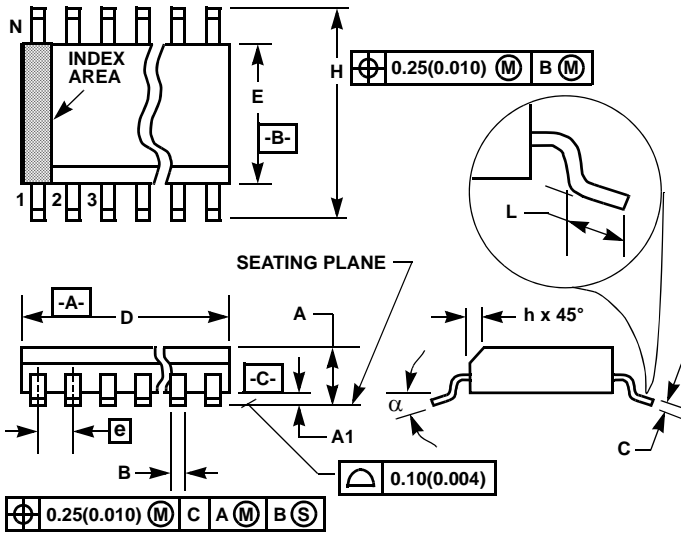

M16.15 (JEDEC MS-012-AC ISSUE C)
16 LEAD NARROW BODY SMALL OUTLINE PLASTIC PACKAGE

SYMBOL	INCHES		MILLIMETERS		NOTES
	MIN	MAX	MIN	MAX	
A	0.0532	0.0688	1.35	1.75	-
A1	0.0040	0.0098	0.10	0.25	-
B	0.013	0.020	0.33	0.51	9
C	0.0075	0.0098	0.19	0.25	-
D	0.3859	0.3937	9.80	10.00	3
E	0.1497	0.1574	3.80	4.00	4
e	0.050 BSC		1.27 BSC		-
H	0.2284	0.2440	5.80	6.20	-
h	0.0099	0.0196	0.25	0.50	5
L	0.016	0.050	0.40	1.27	6
N	16		16		7
alpha	0°	8°	0°	8°	-

NOTES:

1. Symbols are defined in the "MO Series Symbol List" in Section 2.2 of Publication Number 95.
2. Dimensioning and tolerancing per ANSI Y14.5M-1982.
3. Dimension "D" does not include mold flash, protrusions or gate burrs. Mold flash, protrusion and gate burrs shall not exceed 0.15mm (0.006 inch) per side.
4. Dimension "E" does not include interlead flash or protrusions. Interlead flash and protrusions shall not exceed 0.25mm (0.010 inch) per side.
5. The chamfer on the body is optional. If it is not present, a visual index feature must be located within the crosshatched area.
6. "L" is the length of terminal for soldering to a substrate.
7. "N" is the number of terminal positions.
8. Terminal numbers are shown for reference only.
9. The lead width "B", as measured 0.36mm (0.014 inch) or greater above the seating plane, shall not exceed a maximum value of 0.61mm (0.024 inch).
10. Controlling dimension: MILLIMETER. Converted inch dimensions are not necessarily exact.

Rev. 1 6/05

Package Outline Drawing

L16.3x3

16 LEAD QUAD FLAT NO-LEAD PLASTIC PACKAGE

Rev 2, 4/07

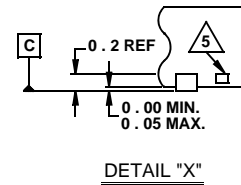
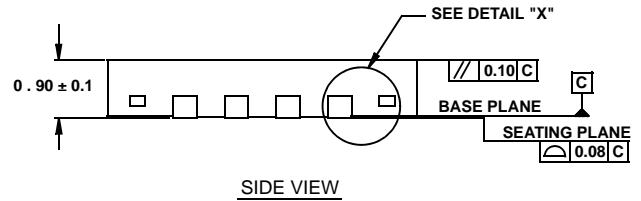
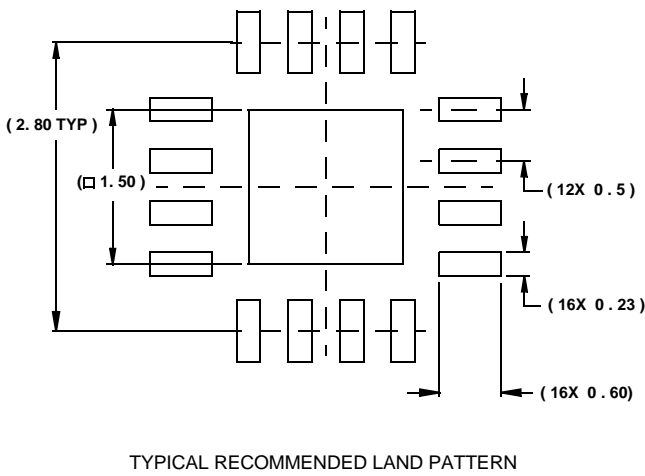
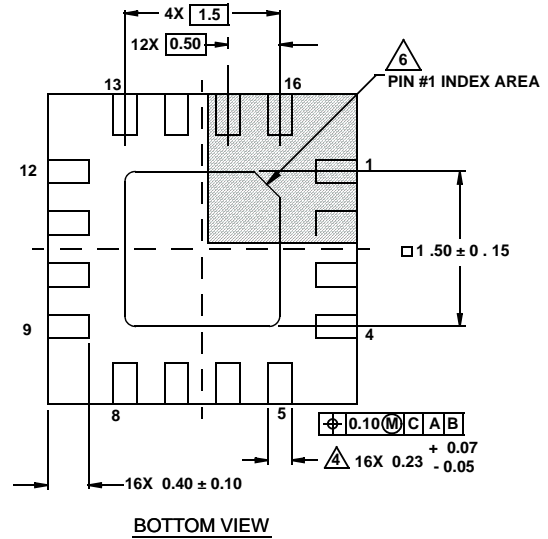
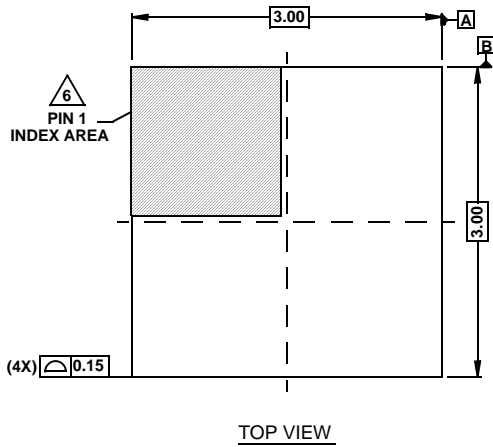

NOTES:

- Dimensions are in millimeters.
Dimensions in () for Reference Only.
- Dimensioning and tolerancing conform to AMSE Y14.5m-1994.
- Unless otherwise specified, tolerance : Decimal ± 0.05
- Dimension b applies to the metallized terminal and is measured between 0.15mm and 0.30mm from the terminal tip.
- Tiebar shown (if present) is a non-functional feature.
- The configuration of the pin #1 identifier is optional, but must be located within the zone indicated. The pin #1 identifier may be either a mold or mark feature.