

μPC2933A, 2905A

R03DS0029EJ0400

Rev.4.00

Mar 16, 2011

THREE-TERMINAL LOW DROPOUT VOLTAGE REGULATOR

Description

The μPC2933A, 2905A of low dropout voltage three terminal positive regulators is constructed with PNP output transistor. The μPC2933A, 2905A feature the ability to source 1 A of output current with a low dropout voltage of typically 0.7 V.

The power dissipation of the μPC2933A, 2905A can be drastically reduced compared with the conventional three terminal positive voltage regulators that is constructed with NPN output transistor. Also, this series corresponds to the low voltage output (3.3 V) which is not in the conventional low dropout regulators (μPC24xxA series).

Features

- Output current in excess of 1.0 A
- Low dropout voltage
V_{DIF} = 0.7 V TYP. (I_o = 1 A)
- On-chip over-current and thermal protection circuit
- On-chip output transistor safe operating area protection circuit

Pin Configurations (Marking Side)

μPC2933AHF,
μPC2905AHF: Isolated TO-220 (MP-45G)

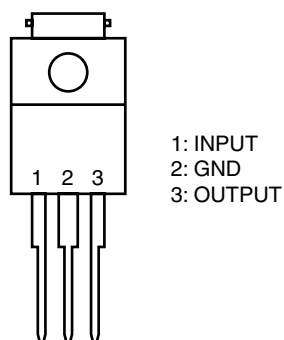

μPC2933AHB,
μPC2905AHB: SC-64 (MP-3)

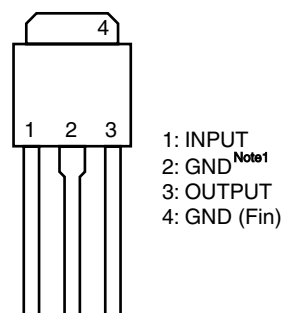

μPC2933AT,
μPC2905AT: SC-63 (MP-3Z)

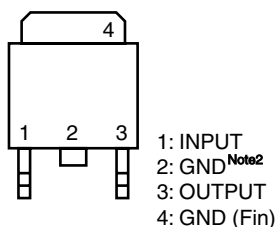

Notes 1. No.2 pin and No.4 fin are common GND.

2. No.2 pin is cut. No.2 pin and No.4 fin are common GND.

The mark <R> shows major revised points.

The revised points can be easily searched by copying an "<R>" in the PDF file and specifying it in the "Find what:" field.

Block Diagram

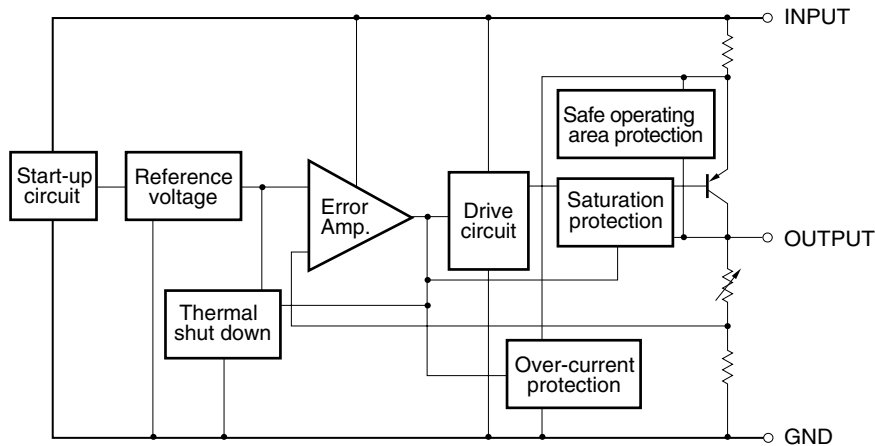

Ordering Information

Part Number	Package	Output Voltage	Marking
μPC2933AHF	Isolated TO-220 (MP-45G)	3.3 V	2933A
μPC2933AHB	SC-64 (MP-3)	3.3 V	2933A
μPC2933AT	SC-63 (MP-3Z)	3.3 V	2933A
μPC2905AHF	Isolated TO-220 (MP-45G)	5.0 V	2905A
μPC2905AHB	SC-64 (MP-3)	5.0 V	2905A
μPC2905AT	SC-63 (MP-3Z)	5.0 V	2905A

Remark Tape-packaged products have the symbol -E1, or -E2 suffixed to the part number. Pb-free products have the symbol -AZ, or -AY suffixed to the part number. Refer to the following table for details.

Part Number ^{Note1}	Package	Package Type
μPC29xxAHF-AZ ^{Note2}	Isolated TO-220 (MP-45G)	• Packed in envelop
μPC29xxAHB-AZ ^{Note2}	SC-64 (MP-3)	• Packed in envelop
μPC29xxAHB-AY ^{Note3}	SC-64 (MP-3)	• Packed in envelop
μPC29xxAT-E1-AZ ^{Note2}	SC-63 (MP-3Z)	• 16 mm wide embossed taping • Pin 1 on draw-out side • 2000 pcs/reel
μPC29xxAT-E1-AY ^{Note3}	SC-63 (MP-3Z)	• 16 mm wide embossed taping • Pin 1 on draw-out side • 2000 pcs/reel
μPC29xxAT-E2-AZ ^{Note2}	SC-63 (MP-3Z)	• 16 mm wide embossed taping • Pin 1 at take-up side • 2000 pcs/reel
μPC29xxAT-E2-AY ^{Note3}	SC-63 (MP-3Z)	• 16 mm wide embossed taping • Pin 1 at take-up side • 2000 pcs/reel

- Notes**
- xx stands for symbols that indicate the output voltage.
 - Pb-free (This product does not contain Pb in the external electrode.)
 - Pb-free (This product does not contain Pb in the external electrode, Sn100% plating.)

Absolute Maximum Ratings (T_A = 25°C)

Parameter	Symbol	Rating		Unit
		μPC2933AHF, 2905AHF	μPC2933AHB, 2905AHB μPC2933AT, 2905AT	
Input Voltage	V _{IN}	20		V
Internal Power Dissipation (T _C = 25°C) ^{Note}	P _T	15	10	W
Operating Ambient Temperature	T _A	-30 to +85		°C
Operating Junction Temperature	T _J	-30 to +150		°C
Storage Temperature	T _{stg}	-55 to +150		°C
Thermal Resistance (junction to case)	R _{th(J-C)}	7	12.5	°C/W
Thermal Resistance (junction to ambient)	R _{th(J-A)}	65	125	°C/W

Note Internally limited. When the operating junction temperature rises above 150°C, the internal circuit shuts down the output voltage.

Caution Product quality may suffer if the absolute maximum rating is exceeded even momentarily for any parameter. That is, the absolute maximum ratings are rated values at which the product is on the verge of suffering physical damage, and therefore the product must be used under conditions that ensure that the absolute maximum ratings are not exceeded.

Typical Connection

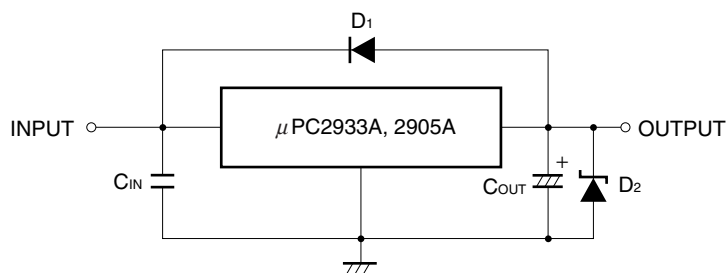

C_{IN} : 0.1 μF or higher. Be sure to connect C_{IN} to prevent parasitic oscillation. Set this value according to the length of the line between the regulator and the INPUT pin. Use of a film capacitor or other capacitor with first-rate voltage and temperature characteristics is recommended. If using a laminated ceramic capacitor, it is necessary to ensure that C_{IN} is 0.1 μF or higher for the voltage and temperature range to be used.

C_{OUT} : 47 μF or higher. Be sure to connect C_{OUT} to prevent oscillation and improve excessive load regulation. Place C_{IN} and C_{OUT} as close as possible to the IC pins (within 1 to 2 cm). Also, use an electrolytic capacitor with low impedance characteristics if considering use at sub-zero temperatures.

D₁ : If the OUTPUT pin has a higher voltage than the INPUT pin, connect a diode.

D₂ : If the OUTPUT pin has a lower voltage than the GND pin, connect a Schottky barrier diode.

Caution Make sure that no voltage is applied to the OUTPUT pin from external.

Recommended Conditions

Parameter	Symbol	Type Number	MIN.	TYP.	MAX.	Unit
Input Voltage	V _{IN}	μPC2933A	4.3		16	V
		μPC2905A	6		16	
Output Current	I _O	All	0		1.0	A
Operating Ambient Temperature	T _A	All	-30		+85	°C
Operating Junction Temperature	T _J	All	-30		+125	°C

Electrical Characteristics

μPC2933A (T_J = 25°C, V_{IN} = 5 V, I_O = 500 mA, C_{IN} = 0.22 μF, C_{OUT} = 47 μF, unless otherwise specified)

<R>

Parameter	Symbol	Conditions	MIN.	TYP.	MAX.	Unit
Output Voltage	V _O		3.18	3.3	3.42	V
		0°C ≤ T _J ≤ 125°C, 4.3 V ≤ V _{IN} ≤ 16 V, 0 A ≤ I _O ≤ 500 mA	3.14		3.46	
		0°C ≤ T _J ≤ 125°C, 0 A ≤ I _O ≤ 1 A				
Line Regulation	REG _{IN}	4.3 V ≤ V _{IN} ≤ 16 V		12	33	mV
Load Regulation	REG _L	0 A ≤ I _O ≤ 1 A		23	33	mV
Quiescent Current	I _{BIAS}	I _O = 0 A		2.0	3.0	mA
		I _O = 1 A		20	40	
Startup Quiescent Current	I _{BIAS (S)}	V _{IN} = 3.1 V, I _O = 0 A		10	30	mA
		V _{IN} = 3.1 V, I _O = 1 A			50	
Quiescent Current Change	ΔI _{BIAS}	0°C ≤ T _J ≤ 125°C, 4.3 V ≤ V _{IN} ≤ 16 V		3.0	15	mA
Output Noise Voltage	V _n	10 Hz ≤ f ≤ 100 kHz		55		μV _{r.m.s.}
Ripple Rejection	R•R	f = 120 Hz, 4.3 V ≤ V _{IN} ≤ 16 V	48	64		dB
Dropout Voltage	V _{DIF}	0°C ≤ T _J ≤ 125°C, I _O = 1 A		0.7	1.0	V
Short Circuit Current	I _{Oshort}	V _{IN} = 4.5 V	1.2	1.6	3.0	A
		V _{IN} = 16 V		1.2		
Peak Output Current	I _{Opeak}	V _{IN} = 4.5 V	1.0	1.4	3.0	A
		V _{IN} = 16 V	1.3	1.7	2.8	
Temperature Coefficient of Output Voltage	ΔV _O /ΔT	0°C ≤ T _J ≤ 125°C, I _O = 5 mA		-0.4		mV/°C

μPC2905A (T_J = 25°C, V_{IN} = 8 V, I_O = 500 mA, C_{IN} = 0.22 μF, C_{OUT} = 47 μF, unless otherwise specified)

Parameter	Symbol	Conditions	MIN.	TYP.	MAX.	Unit
Output Voltage	V _O		4.83	5.0	5.18	V
		0°C ≤ T _J ≤ 125°C, 6 V ≤ V _{IN} ≤ 16 V, 0 A ≤ I _O ≤ 500 mA	4.75		5.25	
		0°C ≤ T _J ≤ 125°C, 0 A ≤ I _O ≤ 1 A				
Line Regulation	REG _{IN}	6 V ≤ V _{IN} ≤ 16 V		23	50	mV
Load Regulation	REG _L	0 A ≤ I _O ≤ 1 A		28	50	mV
Quiescent Current	I _{BIAS}	I _O = 0 A		2.2	3.5	mA
		I _O = 1 A		28	50	
Startup Quiescent Current	I _{BIAS (s)}	V _{IN} = 4.5 V, I _O = 0 A		10	30	mA
		V _{IN} = 4.5 V, I _O = 1 A			50	
Quiescent Current Change	ΔI _{BIAS}	0°C ≤ T _J ≤ 125°C, 6 V ≤ V _{IN} ≤ 16 V		2.9	15	mA
Output Noise Voltage	V _n	10 Hz ≤ f ≤ 100 kHz		90		μV _{r.m.s.}
Ripple Rejection	R•R	f = 120 Hz, 6 V ≤ V _{IN} ≤ 16 V	46	61		dB
Dropout Voltage	V _{DIF}	0°C ≤ T _J ≤ 125°C, I _O = 1 A		0.7	1.0	V
Short Circuit Current	I _{Oshort}	V _{IN} = 6.5 V	1.15	1.8	3.0	A
		V _{IN} = 16 V		1.1		
Peak Output Current	I _{Opeak}	V _{IN} = 6.5 V	1.1	1.5	3.0	A
		V _{IN} = 16 V	1.4	2.0	2.8	
Temperature Coefficient of Output Voltage	ΔV _O /ΔT	0°C ≤ T _J ≤ 125°C, I _O = 5 mA		0.6		mV/°C

Typical Characteristics

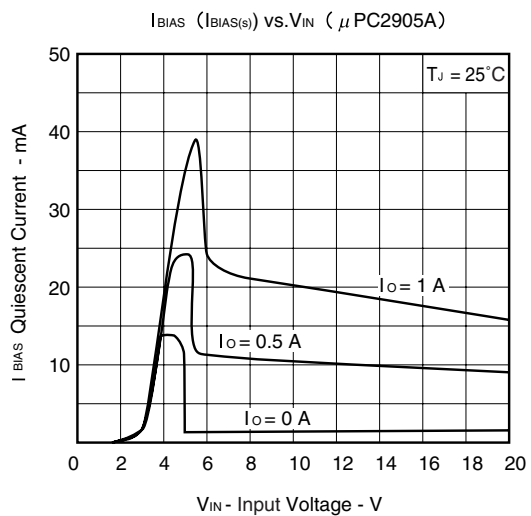
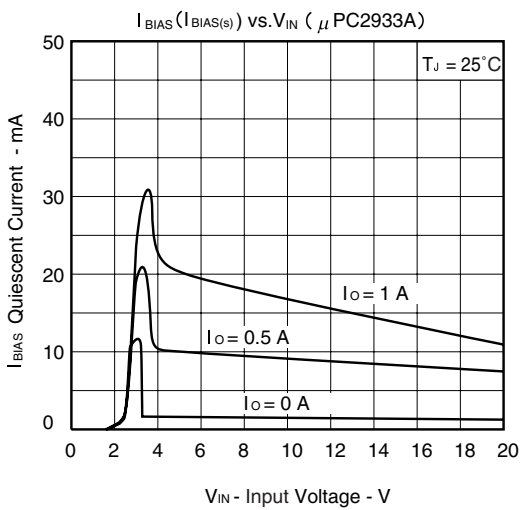
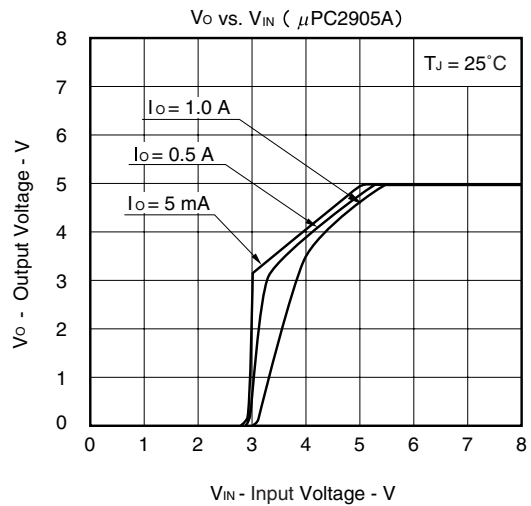
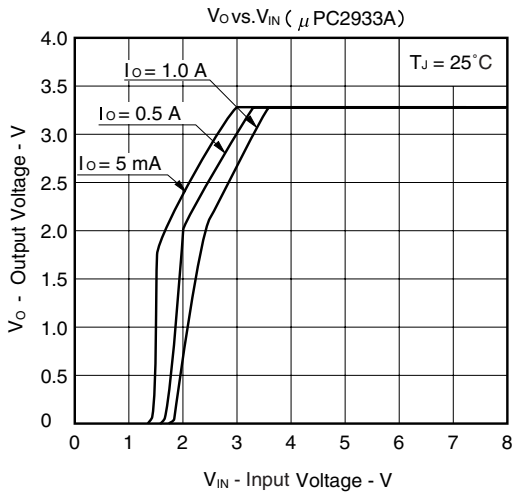
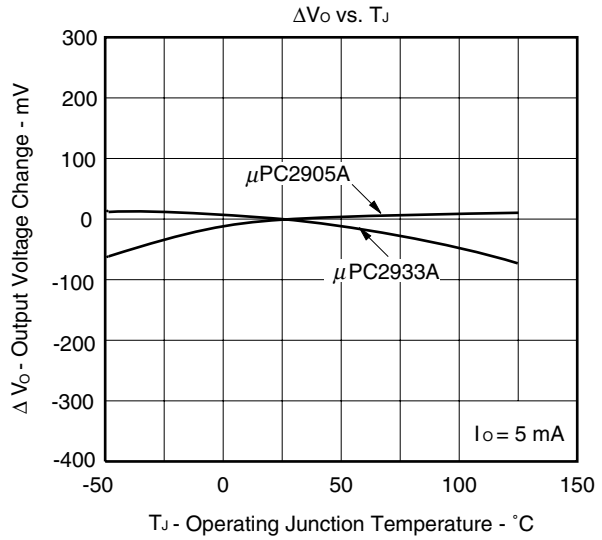
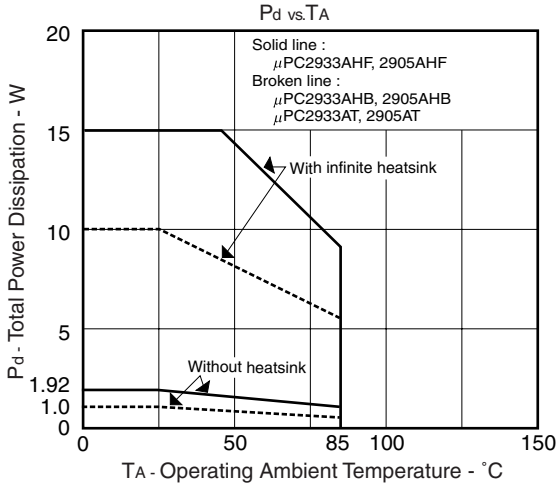

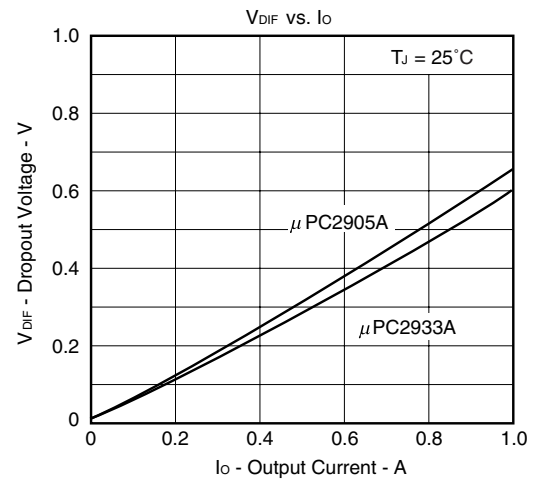
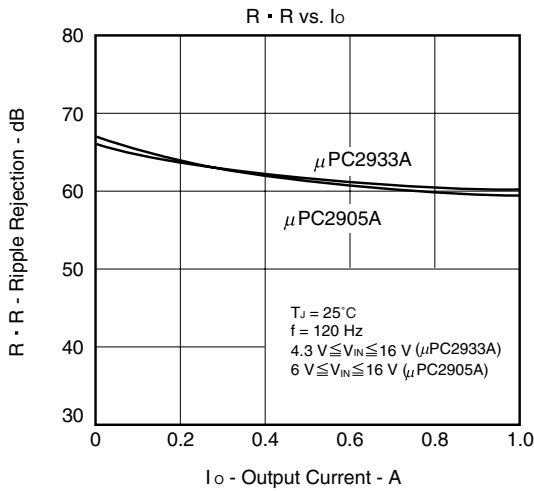
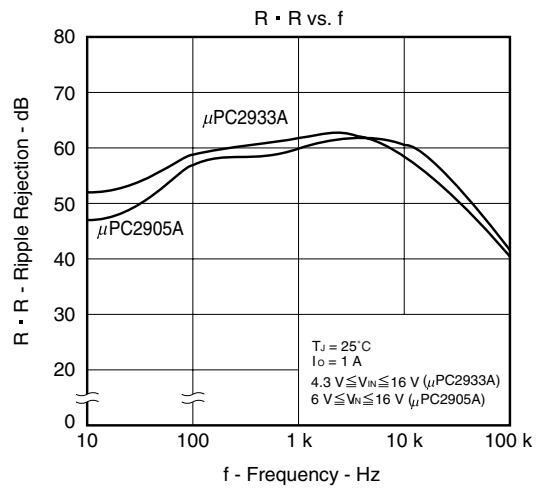
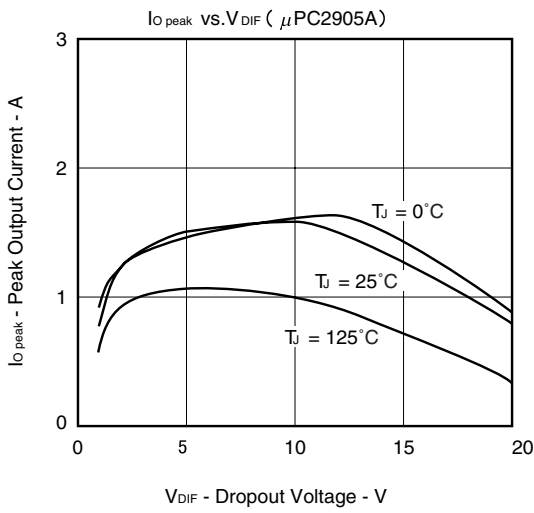
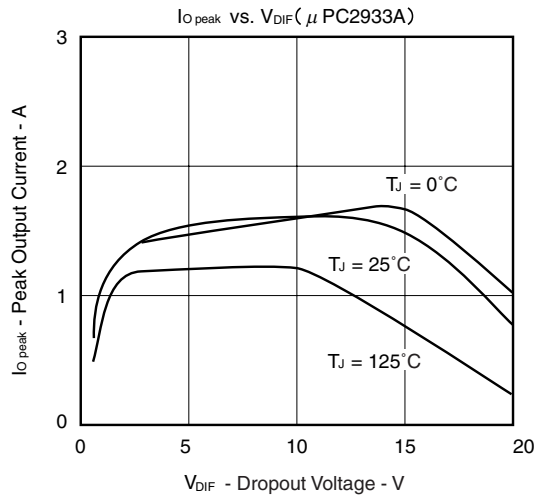
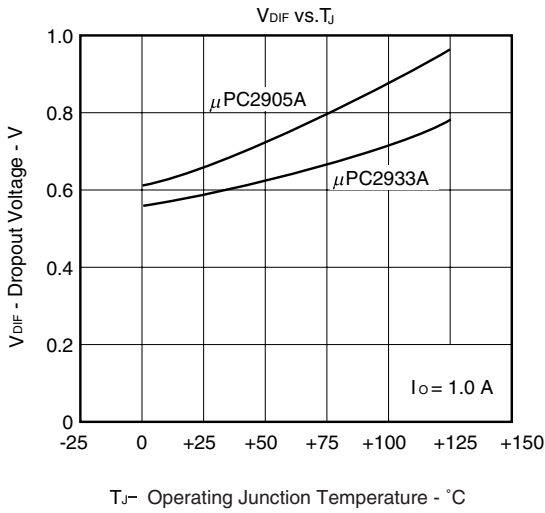

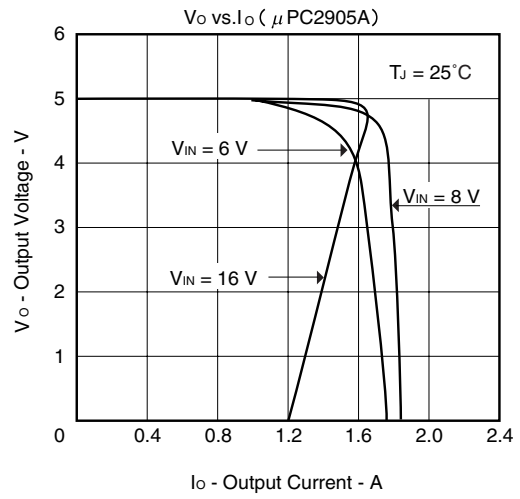
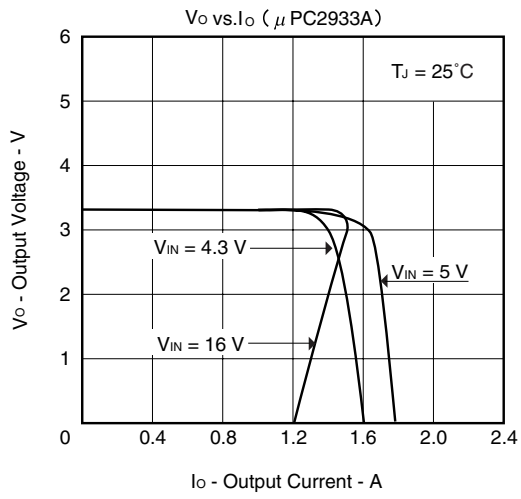

Package Drawings (Unit: mm)

μPC2933AHF, μPC2905AHF

3PIN PLASTIC SIP (MP-45G)

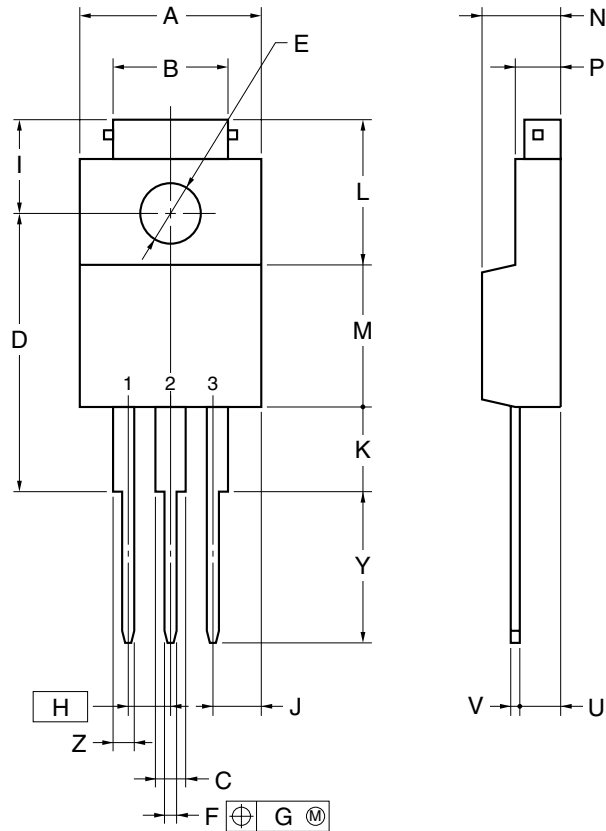

NOTE

Each lead centerline is located within 0.25 mm of its true position (T.P.) at maximum material condition.

ITEM	MILLIMETERS
A	10.0±0.2
B	7.0±0.2
C	1.50±0.2
D	17.0±0.3
E	φ3.3±0.2
F	0.75±0.10
G	0.25
H	2.54 (T.P.)
I	5.0±0.3
J	2.46±0.2
K	5.0±0.2
L	8.5±0.2
M	8.5±0.2
N	4.5±0.2
P	2.8±0.2
U	2.4±0.5
V	0.65±0.10
Y	8.9±0.7
Z	1.30±0.2

P3HF-254B-4

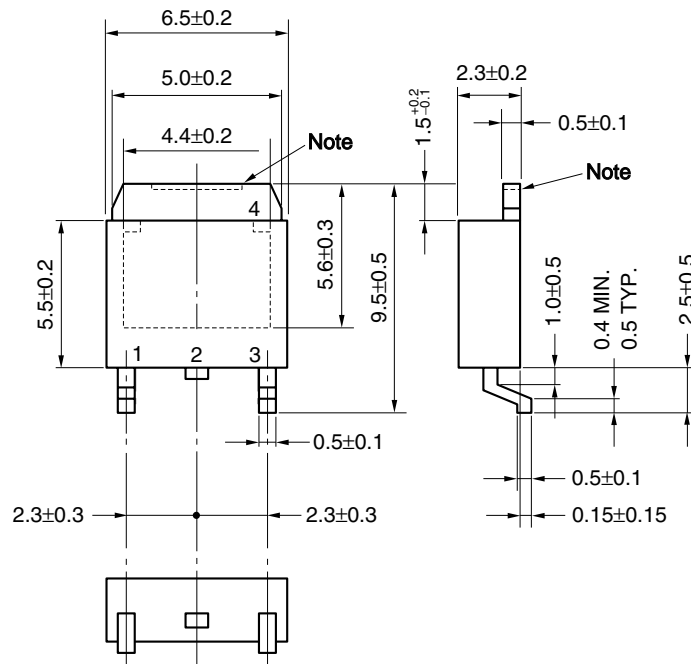
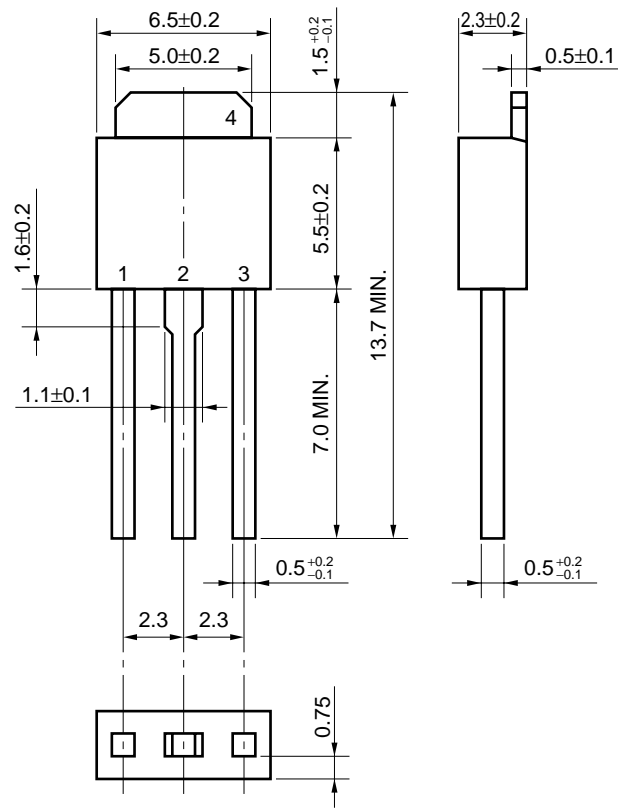

Note The depth of notch at the top of the fin is from 0 to 0.2 mm.

<R> RECOMMENDED SOLDERING CONDITIONS

The μPC2933A, 2905A should be soldered and mounted under the following recommended conditions. For soldering methods and conditions other than those recommended below, contact your nearby sales representative. For technical information, see the following website.

Semiconductor Device Mount Manual (<http://www.renesas.com/prod/package/manual/>)

Surface Mount Device

μPC29xxAT-AZ Series^{Note1}, μPC29xxAT-AY Series^{Note2}: SC-63 (MP-3Z)

Process	Conditions	Symbol
Infrared Ray Reflow	Peak temperature: 260°C or below (Package surface temperature), Reflow time: 60 seconds or less (at 220°C or higher), Maximum number of reflow processes: 3 times or less.	IR60-00-3
Partial Heating Method	Pin temperature: 350°C or below, Heat time: 3 seconds or less (Per each side of the device).	P350

- Notes**
1. Pb-free (This product does not contain Pb in the external electrode.)
 2. Pb-free (This product does not contain Pb in the external electrode, Sn100% plating.)

Caution Apply only one kind of soldering condition to a device, except for "partial heating method", or the device will be damaged by heat stress.

Remark Flux: Rosin-based flux with low chlorine content (chlorine 0.2 Wt% or below) is recommended.

Through-hole devices

μPC29xxAHF-AZ Series^{Note1}: Isolated TO-220 (MP-45G)
μPC29xxAHB-AZ Series^{Note1}, μPC29xxAHB-AY Series^{Note2}: SC-64 (MP-3)

Process	Conditions	Symbol
Wave soldering (only to leads)	Solder temperature: 260°C or below, Flow time: 10 seconds or less.	WS60-00-1
Partial heating method	Pin temperature: 350°C or below, Heat time: 3 seconds or less (Per each pin).	P350

- Notes**
1. Pb-free (This product does not contain Pb in the external electrode.)
 2. Pb-free (This product does not contain Pb in the external electrode, Sn100% plating.)

Caution For through-hole device, the wave soldering process must be applied only to leads, and make sure that the package body does not get jet soldered.

Notes On Use

When the μPC2933A, 2905A are used with an input voltage that is lower than the value indicated in the recommended operating conditions, a high quiescent current flows through the device due to saturation of the transistor of the output stage. (Refer to the “**I_{BIAS} (I_{BIAS(S)}) vs. V_{IN} curves in Typical Characteristics**”).

These products have saturation protector, but a current of up to 80 mA MAX. may flow through the device. Thus the power supply on the input side must have sufficient capacity to allow this quiescent current to pass when the device starts up.

Reference Documents

USER'S MANUAL USAGE OF THREE TERMINAL REGULATORS	Document No.G12702E ^{Note}
REVIEW OF QUALITY AND RELIABILITY HANDBOOK	Document No.C12769E ^{Note}
INFORMATION VOLTAGE REGULATOR OF SMD	Document No.G11872E ^{Note}
SEMICONDUCTOR DEVICE PACKAGE MANUAL	

<http://www.renesas.com/prod/package/index.html>

Note Published by the former NEC Electronics Corporation.

Revision History	μPC2933A,2905A Data Sheet
-------------------------	----------------------------------

Rev.	Date	Description	
		Page	Summary
-	Aug 2007	-	Previous No. : G15374EJ3V0DS00
4.00	Mar 16, 2011	Throughout	Deletion of leaded products
		p.4	μPC2933A Startup Quiescent Current $I_{BIAS(S)}$ 80 mA -> 50 mA @ $V_{IN} = 3.1 V$, $I_o = 1 A$

All trademarks and registered trademarks are the property of their respective owners.

Notice

- All information included in this document is current as of the date this document is issued. Such information, however, is subject to change without any prior notice. Before purchasing or using any Renesas Electronics products listed herein, please confirm the latest product information with a Renesas Electronics sales office. Also, please pay regular and careful attention to additional and different information to be disclosed by Renesas Electronics such as that disclosed through our website.
- Renesas Electronics does not assume any liability for infringement of patents, copyrights, or other intellectual property rights of third parties by or arising from the use of Renesas Electronics products or technical information described in this document. No license, express, implied or otherwise, is granted hereby under any patents, copyrights or other intellectual property rights of Renesas Electronics or others.
- You should not alter, modify, copy, or otherwise misappropriate any Renesas Electronics product, whether in whole or in part.
- Descriptions of circuits, software and other related information in this document are provided only to illustrate the operation of semiconductor products and application examples. You are fully responsible for the incorporation of these circuits, software, and information in the design of your equipment. Renesas Electronics assumes no responsibility for any losses incurred by you or third parties arising from the use of these circuits, software, or information.
- When exporting the products or technology described in this document, you should comply with the applicable export control laws and regulations and follow the procedures required by such laws and regulations. You should not use Renesas Electronics products or the technology described in this document for any purpose relating to military applications or use by the military, including but not limited to the development of weapons of mass destruction. Renesas Electronics products and technology may not be used for or incorporated into any products or systems whose manufacture, use, or sale is prohibited under any applicable domestic or foreign laws or regulations.
- Renesas Electronics has used reasonable care in preparing the information included in this document, but Renesas Electronics does not warrant that such information is error free. Renesas Electronics assumes no liability whatsoever for any damages incurred by you resulting from errors in or omissions from the information included herein.
- Renesas Electronics products are classified according to the following three quality grades: "Standard", "High Quality", and "Specific". The recommended applications for each Renesas Electronics product depends on the product's quality grade, as indicated below. You must check the quality grade of each Renesas Electronics product before using it in a particular application. You may not use any Renesas Electronics product for any application categorized as "Specific" without the prior written consent of Renesas Electronics. Further, you may not use any Renesas Electronics product for any application for which it is not intended without the prior written consent of Renesas Electronics. Renesas Electronics shall not be in any way liable for any damages or losses incurred by you or third parties arising from the use of any Renesas Electronics product for an application categorized as "Specific" or for which the product is not intended where you have failed to obtain the prior written consent of Renesas Electronics. The quality grade of each Renesas Electronics product is "Standard" unless otherwise expressly specified in a Renesas Electronics data sheets or data books, etc.
"Standard": Computers; office equipment; communications equipment; test and measurement equipment; audio and visual equipment; home electronic appliances; machine tools; personal electronic equipment; and industrial robots.
"High Quality": Transportation equipment (automobiles, trains, ships, etc.); traffic control systems; anti-disaster systems; anti-crime systems; safety equipment; and medical equipment not specifically designed for life support.
"Specific": Aircraft; aerospace equipment; submersible repeaters; nuclear reactor control systems; medical equipment or systems for life support (e.g. artificial life support devices or systems), surgical implantations, or healthcare intervention (e.g. excision, etc.), and any other applications or purposes that pose a direct threat to human life.
- You should use the Renesas Electronics products described in this document within the range specified by Renesas Electronics, especially with respect to the maximum rating, operating supply voltage range, movement power voltage range, heat radiation characteristics, installation and other product characteristics. Renesas Electronics shall have no liability for malfunctions or damages arising out of the use of Renesas Electronics products beyond such specified ranges.
- Although Renesas Electronics endeavors to improve the quality and reliability of its products, semiconductor products have specific characteristics such as the occurrence of failure at a certain rate and malfunctions under certain use conditions. Further, Renesas Electronics products are not subject to radiation resistance design. Please be sure to implement safety measures to guard them against the possibility of physical injury, and injury or damage caused by fire in the event of the failure of a Renesas Electronics product, such as safety design for hardware and software including but not limited to redundancy, fire control and malfunction prevention, appropriate treatment for aging degradation or any other appropriate measures. Because the evaluation of microcomputer software alone is very difficult, please evaluate the safety of the final products or system manufactured by you.
- Please contact a Renesas Electronics sales office for details as to environmental matters such as the environmental compatibility of each Renesas Electronics product. Please use Renesas Electronics products in compliance with all applicable laws and regulations that regulate the inclusion or use of controlled substances, including without limitation, the EU RoHS Directive. Renesas Electronics assumes no liability for damages or losses occurring as a result of your noncompliance with applicable laws and regulations.
- This document may not be reproduced or duplicated, in any form, in whole or in part, without prior written consent of Renesas Electronics.
- Please contact a Renesas Electronics sales office if you have any questions regarding the information contained in this document or Renesas Electronics products, or if you have any other inquiries.
(Note 1) "Renesas Electronics" as used in this document means Renesas Electronics Corporation and also includes its majority-owned subsidiaries.
(Note 2) "Renesas Electronics product(s)" means any product developed or manufactured by or for Renesas Electronics.



SALES OFFICES

Renesas Electronics Corporation

<http://www.renesas.com>

Refer to "<http://www.renesas.com/>" for the latest and detailed information.

Renesas Electronics America Inc.
2880 Scott Boulevard Santa Clara, CA 95050-2554, U.S.A.
Tel: +1-408-586-6000, Fax: +1-408-586-6130

Renesas Electronics Canada Limited
1101 Nicholson Road, Newmarket, Ontario L3Y 9C3, Canada
Tel: +1-905-898-5441, Fax: +1-905-898-3220

Renesas Electronics Europe Limited
Dukes Meadow, Millboard Road, Bourne End, Buckinghamshire, SL8 5FH, U.K.
Tel: +44-1628-585-100, Fax: +44-1628-585-900

Renesas Electronics Europe GmbH
Arcadiastrasse 10, 40472 Düsseldorf, Germany
Tel: +49-211-65030, Fax: +49-211-6503-1327

Renesas Electronics (China) Co., Ltd.
7th Floor, Quantum Plaza, No.27 ZhiChunLu Haidian District, Beijing 100083, P.R.China
Tel: +86-10-8235-1155, Fax: +86-10-8235-7679

Renesas Electronics (Shanghai) Co., Ltd.
Unit 204, 205, AZIA Center, No.1233 Lujiazui Ring Rd., Pudong District, Shanghai 200120, China
Tel: +86-21-5877-1818, Fax: +86-21-6887-7858 / -7898

Renesas Electronics Hong Kong Limited
Unit 1601-1613, 16/F., Tower 2, Grand Century Place, 193 Prince Edward Road West, Mongkok, Kowloon, Hong Kong
Tel: +852-2886-9318, Fax: +852 2886-9022/9044

Renesas Electronics Taiwan Co., Ltd.
7F, No. 363 Fu Shing North Road Taipei, Taiwan
Tel: +886-2-8175-9600, Fax: +886 2-8175-9670

Renesas Electronics Singapore Pte. Ltd.
1 HarbourFront Avenue, #06-10, Keppel Bay Tower, Singapore 098632
Tel: +65-6213-0200, Fax: +65-6276-8001

Renesas Electronics Malaysia Sdn.Bhd.
Unit 906, Block B, Menara Amcorp, Amcorp Trade Centre, No. 18, Jin Persiaran Barat, 46050 Petaling Jaya, Selangor Darul Ehsan, Malaysia
Tel: +60-3-7955-9390, Fax: +60-3-7955-9510

Renesas Electronics Korea Co., Ltd.
11F., Samik Lavied' or Bldg., 720-2 Yeoksam-Dong, Kangnam-Ku, Seoul 135-080, Korea
Tel: +82-2-558-3737, Fax: +82-2-558-5141