

**Description**

- Surface mount oscillator in a ceramic package with a hermetically sealed metal lid
- Model IQXO-70
- Model Issue number 11

**Frequency Parameters**

- Frequency 10.0MHz
- Frequency Stability  $\pm 50.00\text{ppm}$
- Operating Temperature Range  $-40.00$  to  $85.00^\circ\text{C}$
- Ageing  $\pm 5\text{ppm}$  max in 1st year

**Electrical Parameters**

- Supply Voltage  $5.0\text{V} \pm 0.5\text{V}$
- Current Draw  $27.00\text{mA}$

**Output Details**

- Output Compatibility HCMOS
- Drive Capability  $50\text{pF}$  max
- Rise and Fall Time  $7.0\text{ns}$  max
- Duty Cycle  $45/55\%$

**Output Control**

- Tri-state Operation:  
 Logic '1' ( $2.2\text{V}$  min) to pad 1 enables oscillator output  
 Logic '0' ( $0.8\text{V}$  max) to pad 1 disables oscillator output; when disabled the oscillator output goes to the high impedance state  
 No connection to pad 1 enables oscillator output

**Environmental Parameters**

- Shock: MIL-STD-202F, Method 213B: 1000G, 0.5ms, 1/2 sine
- Vibration: MIL-STD-202F, Method 204D, Test Condition D: 20G, frequency range 10-2000Hz 2hrs in 3 mutually perpendicular planes (total 6hrs)
- Storage Temperature Range:  $-55$  to  $125^\circ\text{C}$

**Compliance**

- RoHS Status (2011/65/EU) Compliant
- REACH Status Compliant
- MSL Rating (JEDEC-STD-033): Not Applicable

**Packaging Details**

- Pack Style: Bulk Loose in bulk pack  
Pack Size: 100
- *Alternative packing option available*

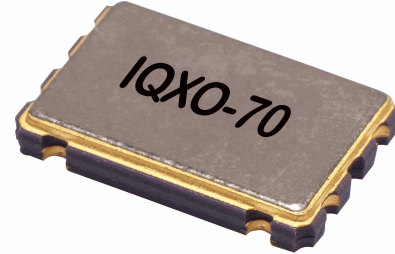
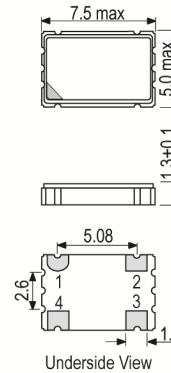
**Outline (mm)**

- Pad Connections
1. Enable/Disable
  2. GND
  3. Output
  4. +Vs

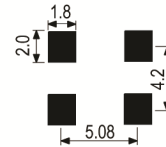
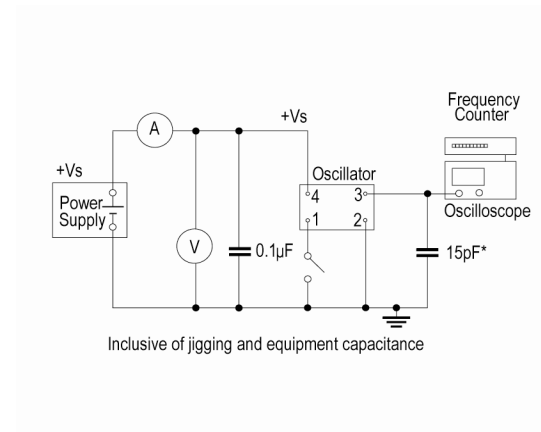
**Solder Pad Layout**

**Test Circuit**

**Sales Office Contact Details:**

UK: +44 (0)1460 270200  
 Germany: 0800 1808 443

France: 0800 901 383  
 USA: +1.760.318.2824

Email: [info@iqdfrequencyproducts.com](mailto:info@iqdfrequencyproducts.com)  
 Web: [www.iqdfrequencyproducts.com](http://www.iqdfrequencyproducts.com)

**Wave Form**



**Sales Office Contact Details:**

UK: +44 (0)1460 270200  
Germany: 0800 1808 443

France: 0800 901 383  
USA: +1.760.318.2824

Email: [info@iqdfrequencyproducts.com](mailto:info@iqdfrequencyproducts.com)  
Web: [www.iqdfrequencyproducts.com](http://www.iqdfrequencyproducts.com)