



2SB834

PNP SILICON TRANSISTOR

HIGH VOLTAGE TRANSISTOR

DESCRIPTION

Low frequency power amplifier applications.

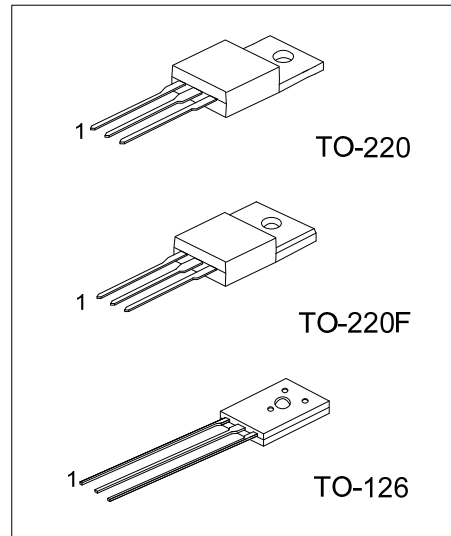

Lead-Free: 2SB834L

Halogen Free: 2SB834G

ORDERING INFORMATION

Ordering Number			Package	Pin Assignment			Packing
Normal	Lead Free	Halogen Free		1	2	3	
2SB834-x-T60-K	2SB834L-x-T60-K	2SB834G-x-T60-K	TO-126	E	C	B	Bulk
2SB834-x-TA3-T	2SB834L-x-TA3-T	2SB834G-x-TA3-T	TO-220	B	C	E	Tube
2SB834-x-TF3-T	2SB834L-x-TF3-T	2SB834G-x-TF3-T	TO-220F	B	C	E	Tube

<p>2SB834L-x-T60-K</p> <p>(1)Packing Type (2)Package Type (3)Rank (4)Lead Plating</p>	<p>(1) K: Bulk, T: Tube (2) T60: TO-126, TA3: TO-220, TF3:TO-220F (3) x: refer to Classification of h_{FE1} (4) G: Halogen Free, L: Lead Free, Blank: Pb/Sn</p>
---	--

■ ABSOLUTE MAXIMUM RATINGS (Operating temperature range applies unless otherwise specified)

PARAMETER		SYMBOL	RATINGS	UNIT
Collector-Base Voltage		V_{CBO}	-60	V
Collector-Emitter Voltage		V_{CEO}	-60	V
Emitter-Base Voltage		V_{EBO}	-7	V
Collector Current		I_C	-3	A
Base Current		I_B	-0.5	A
Power Dissipation ($T_C=25^\circ\text{C}$)	TO-126/TO-220F	P_C	25	W
	TO-220		30	W
Junction Temperature		T_J	+125	$^\circ\text{C}$
Storage Temperature		T_{STG}	-40 ~ +150	$^\circ\text{C}$

Note: Absolute maximum ratings are those values beyond which the device could be permanently damaged.

Absolute maximum ratings are stress ratings only and functional device operation is not implied.

■ ELECTRICAL CHARACTERISTICS ($T_a=25^\circ\text{C}$, unless otherwise specified)

PARAMETER	SYMBOL	TEST CONDITIONS	MIN	TYP	MAX	UNIT
Collector-Emitter Breakdown Voltage	BV_{CEO}	$I_C=-50\text{mA}$	-60			V
Collector Cut-Off Current	I_{CBO}	$V_{CB}=-60\text{V}$			-100	μA
Emitter Cut-Off Current	I_{EBO}	$V_{EB}=-7\text{V}$			-100	μA
Collector-Emitter Saturation Voltage	$V_{CE(SAT)}$	$I_C=-3\text{A}, I_B=0.3\text{A}$			-1	V
Base-Emitter On Voltage	$V_{BE(ON)}$	$V_{CE}=-5\text{V}, I_C=-0.5\text{A}$		-0.7	-1	V
DC Current Gain	h_{FE1}	$I_C=-0.5\text{A}, V_{CE}=-5\text{V}$	60		300	
	h_{FE2}	$I_C=-3\text{A}, V_{CE}=-5\text{V}$	20			
Current Gain Bandwidth Product	f_T	$V_{CE}=-5\text{V}, I_C=-0.5\text{A}$		9		MHZ

■ CLASSIFICATION of h_{FE1}

RANK	O	Y	GR
RANGE	60-120	100-200	150-300

TYPICAL CHARACTERISTICS

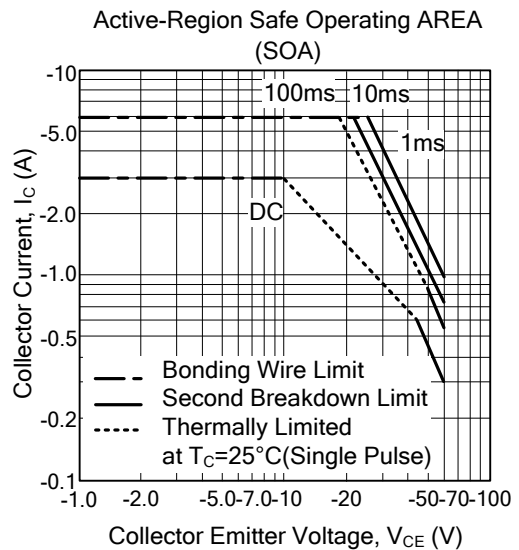
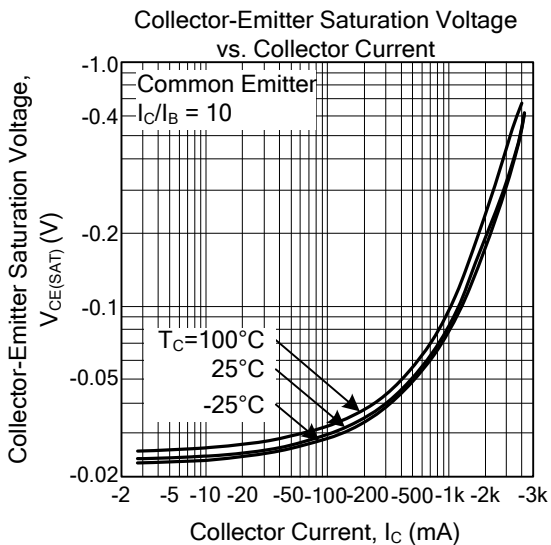
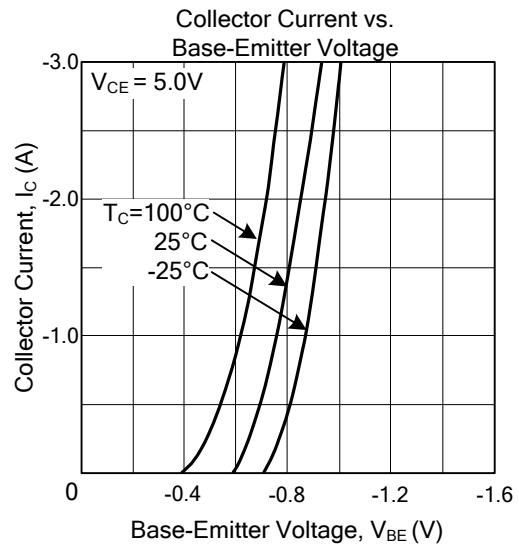
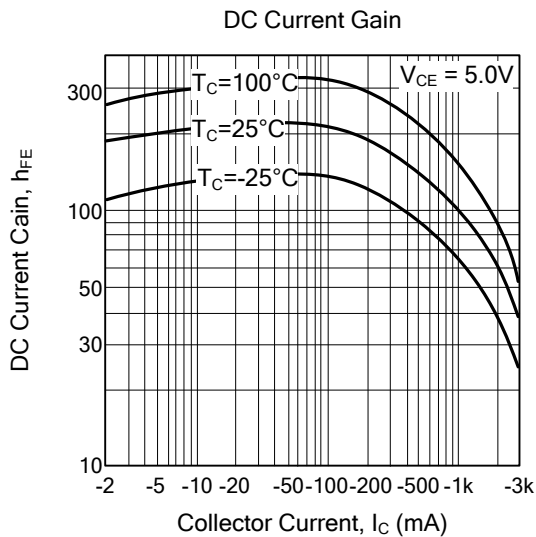
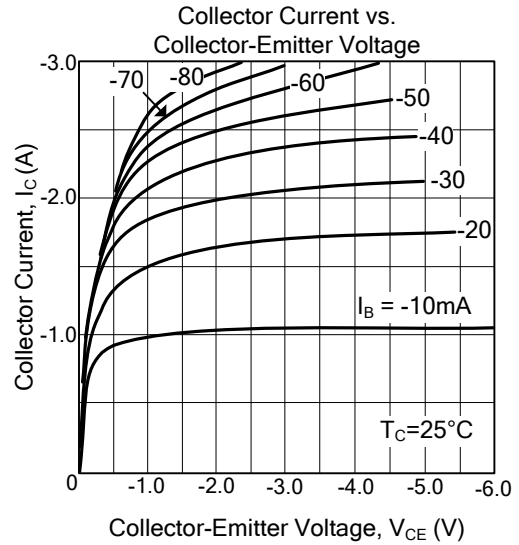
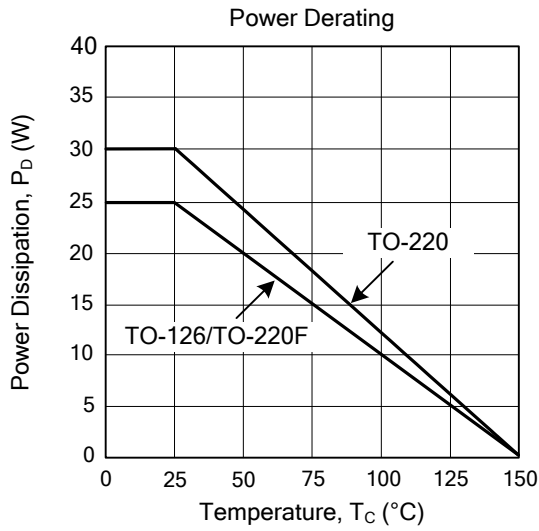

UTC assumes no responsibility for equipment failures that result from using products at values that exceed, even momentarily, rated values (such as maximum ratings, operating condition ranges, or other parameters) listed in products specifications of any and all UTC products described or contained herein. UTC products are not designed for use in life support appliances, devices or systems where malfunction of these products can be reasonably expected to result in personal injury. Reproduction in whole or in part is prohibited without the prior written consent of the copyright owner. The information presented in this document does not form part of any quotation or contract, is believed to be accurate and reliable and may be changed without notice.