

TLE2227, TLE2227Y, TLE2237, TLE2237Y EXCALIBUR LOW-NOISE HIGH-SPEED PRECISION DUAL OPERATIONAL AMPLIFIERS

SLOS184 – FEBRUARY 1997

- Outstanding Combination of DC Precision and AC Performance:

Unity-Gain Bandwidth . . . 15 MHz Typ
 V_n . . . 3.3 nV/ $\sqrt{\text{Hz}}$ at $f = 10$ Hz Typ,
 2.5 nV/ $\sqrt{\text{Hz}}$ at $f = 1$ kHz Typ
 V_{IO} . . . 100 μV Typ
 A_{VD} . . . 45 V/ μV Typ With $R_L = 2$ k Ω
 38 V/ μV Typ With $R_L = 1$ k Ω

- Available in 16-Pin Small-Outline Wide-Body Package
- Macromodels and Statistical Information Included
- Output Features Saturation Recovery Circuitry

description

The TLE22x7C combines innovative circuit design expertise and high-quality process control techniques to produce a level of ac performance and dc precision previously unavailable in dual operational amplifiers. This device allows upgrades to systems that use lower-precision devices and is manufactured using Texas Instruments state-of-the-art Excalibur process.

In the area of dc precision, the TLE22x7C offers a typical offset voltage of 100 μV , a common-mode rejection ratio of 115 dB (typ), a supply voltage rejection ratio of 120 dB (typ), and a dc gain of 45 V/ μV (typ).

The ac performance is highlighted by a typical unity-gain bandwidth specification of 15 MHz, 55° of phase margin, and noise voltage specifications of 3.3 nV/ $\sqrt{\text{Hz}}$ and 2.5 nV/ $\sqrt{\text{Hz}}$ at frequencies of 10 Hz and 1 kHz, respectively.

The TLE22x7C is available in a wide variety of packages, including the industry standard 16-pin small-outline wide-body version for high-density system applications. This device is characterized for operation from 0°C to 70°C.

P PACKAGE
(TOP VIEW)

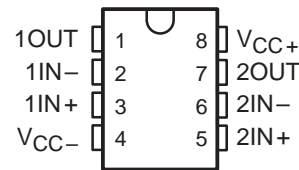

DW PACKAGE
(TOP VIEW)

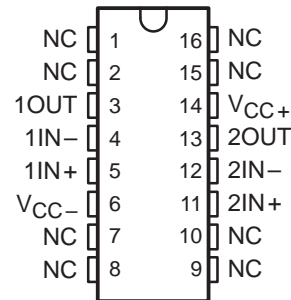

NC – No internal connection

AVAILABLE OPTIONS

T _A	V _{IO} typ AT 25°C	PACKAGED DEVICES		CHIP FORM‡ (Y)
		SMALL OUTLINE† (DW)	PLASTIC DIP (P)	
0°C to 70°C	100 μV	TLE2227CDW	TLE2227CP	TLE2227Y
	100 μV	TLE2237CDW	TLE2237CP	TLE2237Y

† The DW package is available taped and reeled. Add R suffix to device type (e.g., TLE2227CDWR).

‡ Chip forms are tested at 25°C only.



Please be aware that an important notice concerning availability, standard warranty, and use in critical applications of Texas Instruments semiconductor products and disclaimers thereto appears at the end of this data sheet.

PRODUCTION DATA information is current as of publication date. Products conform to specifications per the terms of Texas Instruments standard warranty. Production processing does not necessarily include testing of all parameters.

 **TEXAS
INSTRUMENTS**

POST OFFICE BOX 655303 • DALLAS, TEXAS 75265

Copyright © 1997, Texas Instruments Incorporated

TLE2227, TLE2227Y, TLE2237, TLE2237Y EXCALIBUR LOW-NOISE HIGH-SPEED PRECISION DUAL OPERATIONAL AMPLIFIERS

SLOS184 – FEBRUARY 1997

symbol (each amplifier)

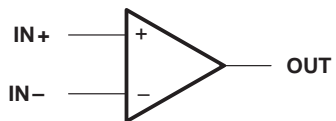

TLE2227Y chip information

This chip, properly assembled, displays characteristics similar to the TLE2227C. Thermal compression or ultrasonic bonding may be used on the doped-aluminum bonding pads. Chips may be mounted with conductive epoxy or a gold-silicon preform.

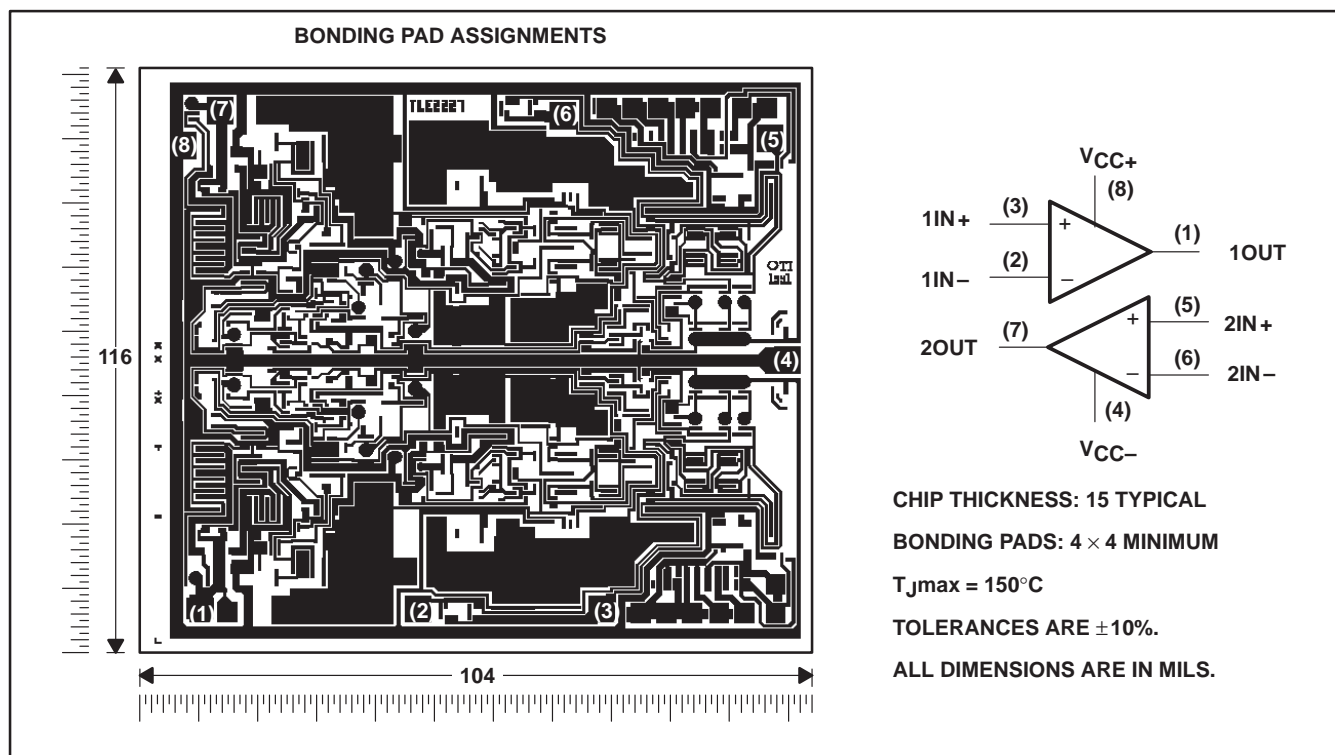

TLE2227, TLE2227Y, TLE2237, TLE2237Y EXCALIBUR LOW-NOISE HIGH-SPEED PRECISION DUAL OPERATIONAL AMPLIFIERS

SLOS184 – FEBRUARY 1997

TLE2237Y chip information

This chip, when properly assembled, displays characteristics similar to TLE2237. Thermal compression or ultrasonic bonding may be used on the doped-aluminum bonding pads. The chip may be mounted with conductive epoxy or a gold-silicon preform.

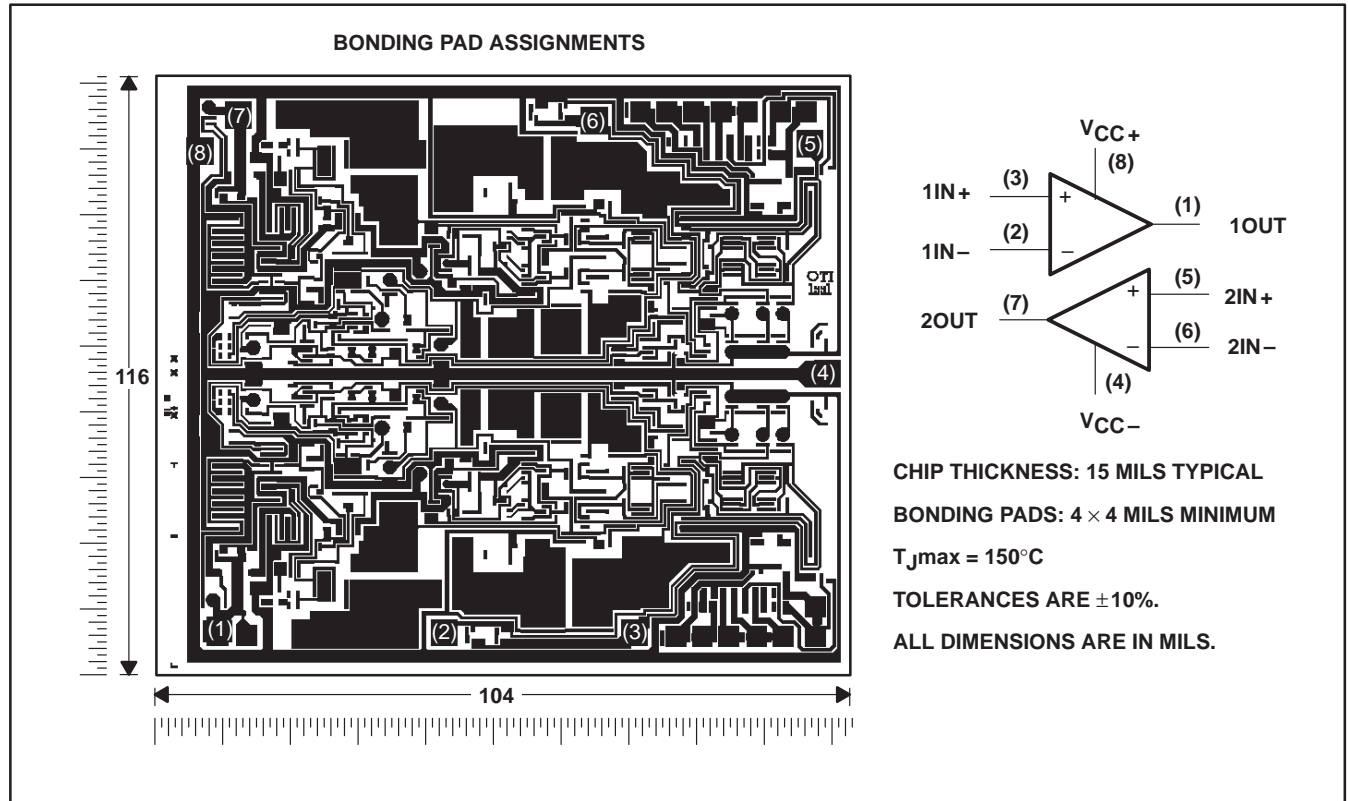

TLE2227, TLE2227Y, TLE2237, TLE2237Y
 EXCALIBUR LOW-NOISE HIGH-SPEED
 PRECISION DUAL OPERATIONAL AMPLIFIERS
 SLOS184 - FEBRUARY 1997

equivalent schematic (each amplifier)

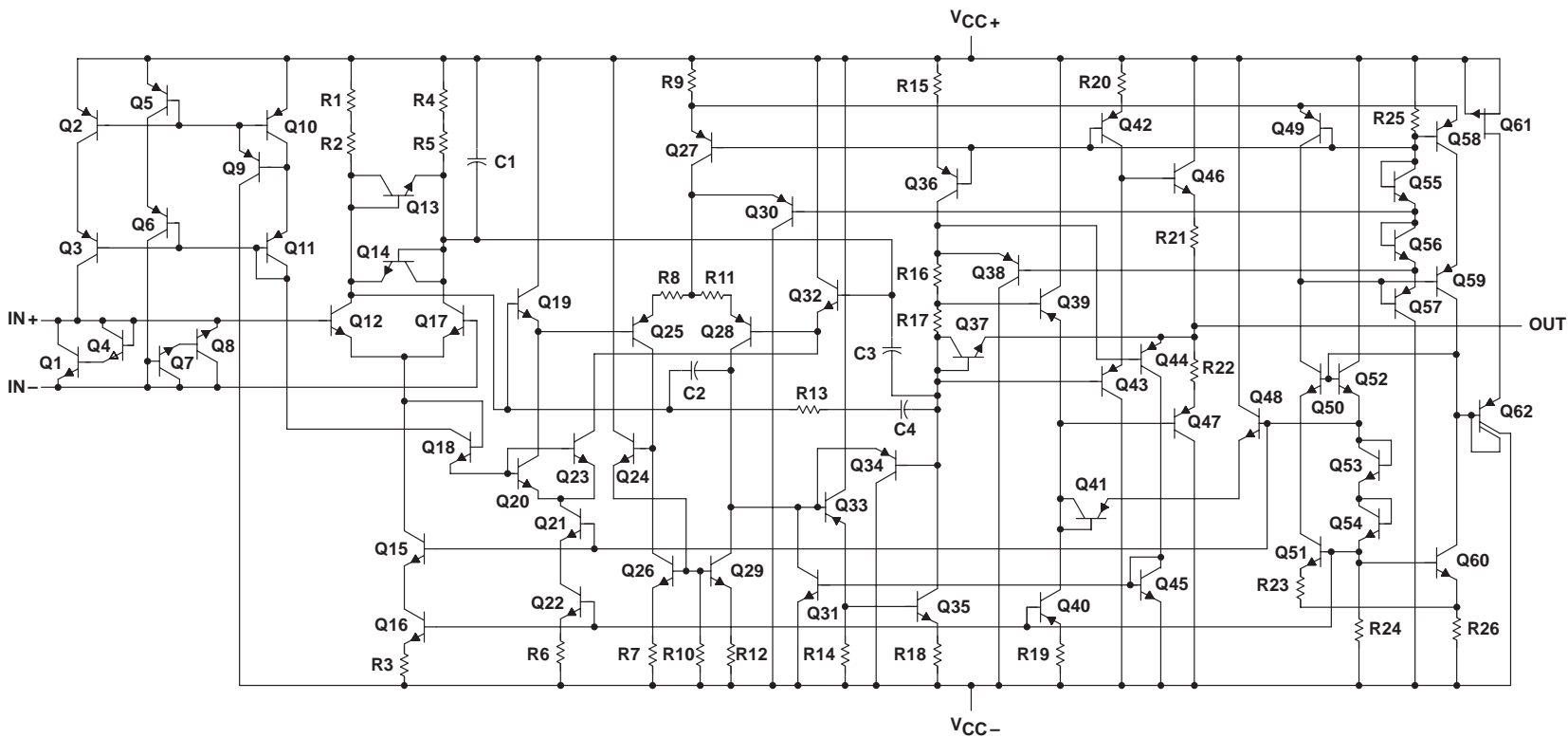

ACTUAL DEVICE COMPONENT COUNT		
COMPONENT	TLE2227	TLE2237
Transistors	62	62
Resistors	24	24
Diodes	0	0
Capacitors	4	4

TLE2227, TLE2227Y, TLE2237, TLE2237Y
EXCALIBUR LOW-NOISE HIGH-SPEED
PRECISION DUAL OPERATIONAL AMPLIFIERS

SLOS184 – FEBRUARY 1997

absolute maximum ratings over operating free-air temperature range (unless otherwise noted)†

Supply voltage, V_{CC+} (see Note 1)	19 V
Supply voltage, V_{CC-}	-19 V
Differential input voltage, V_{ID} (see Note 2)	± 1.2 V
Input voltage range, V_I (any input)	$V_{CC\pm}$
Input current, I_I (each input)	± 1 mA
Output current, I_O	± 50 mA
Total current into V_{CC+}	50 mA
Total current out of V_{CC-}	50 mA
Duration of short-circuit current at (or below) 25°C (see Note 3)	unlimited
Continuous total dissipation	See Dissipation Rating Table
Operating free-air temperature range, T_A	0°C to 70°C
Lead temperature 1,6 mm (1/16 inch) from case for 10 seconds	260°C

† Stresses beyond those listed under “absolute maximum ratings” may cause permanent damage to the device. These are stress ratings only, and functional operation of the device at these or any other conditions beyond those indicated under “recommended operating conditions” is not implied. Exposure to absolute-maximum-rated conditions for extended periods may affect device reliability.

- NOTES:
1. All voltage values, except differential voltages, are with respect to the midpoint between V_{CC+} and V_{CC-} .
 2. Differential voltages are at $IN+$ with respect to $IN-$. Excessive current flows if a differential input voltage in excess of approximately ± 1.2 V is applied between the inputs unless some limiting resistance is used.
 3. The output can be shorted to either supply. Temperature and/or supply voltages must be limited to ensure that the maximum dissipation rating is not exceeded.

DISSIPATION RATING TABLE

PACKAGE	$T_A \leq 25^\circ\text{C}$ POWER RATING	DERATING FACTOR ABOVE $T_A = 25^\circ\text{C}$	$T_A = 70^\circ\text{C}$ POWER RATING
DW	1025 mW	8.2 mW/°C	656 mW
P	1000 mW	8.0 mW/°C	640 mW

recommended operating conditions

	MIN	MAX	UNIT
Supply voltage, $V_{CC\pm}$	± 4	± 19	V
Common-mode input voltage, V_{IC}	$T_A = 25^\circ\text{C}$		V
	$T_A = \text{Full range}^\dagger$		
Operating free-air temperature, T_A	0	70	°C

† Full range is 0°C to 70°C.



TLE2227, TLE2227Y, TLE2237, TLE2237Y EXCALIBUR LOW-NOISE HIGH-SPEED PRECISION DUAL OPERATIONAL AMPLIFIERS

SLOS184 – FEBRUARY 1997

electrical characteristics at specified free-air temperature, $V_{CC\pm} = \pm 15\text{ V}$ (unless otherwise noted)

PARAMETER	TEST CONDITIONS	T_A †	TLE2227C			UNIT
			MIN	TYP	MAX	
V_{IO} Input offset voltage	$V_{IC} = 0,$ $R_S = 50\ \Omega$	25°C	100	350	μV	
		Full range	500			
α_{VIO} Temperature coefficient of input offset voltage		Full range	0.4	1	$\mu\text{V}/^\circ\text{C}$	
Input offset voltage long-term drift (see Note 4)		25°C	0.006	1	$\mu\text{V}/\text{mo}$	
I_{IO} Input offset current		25°C	7.5	90	nA	
		Full range	150			
I_{IB} Input bias current	25°C	15	90	nA		
	Full range	150				
V_{ICR} Common-mode input voltage range	$R_S = 50\ \Omega$	25°C	-11 to 11	-13 to 13	V	
		Full range	-10.5 to 10.5			
V_{OM+} Maximum positive peak output voltage swing	$R_L = 1\ \text{k}\Omega$	25°C	10.5		V	
		Full range	10			
	$R_L = 2\ \text{k}\Omega$	25°C	12			
		Full range	11			
V_{OM-} Maximum negative peak output voltage swing	$R_L = 1\ \text{k}\Omega$	25°C	-10.5	-13	V	
		Full range	-10			
	$R_L = 2\ \text{k}\Omega$	25°C	-12	-13.5		
		Full range	-11			
A_{VD} Large-signal differential voltage amplification	$V_O = \pm 11\ \text{V},$ $R_L = 2\ \text{k}\Omega$	25°C	2.5	45	$\text{V}/\mu\text{V}$	
		Full range	2			
	$V_O = \pm 10\ \text{V},$ $R_L = 1\ \text{k}\Omega$	25°C	3.5	38		
		Full range	1			
c_i Input capacitance		25°C	8		pF	
z_o Open-loop output impedance	$I_O = 0$	25°C	50		Ω	
CMRR Common-mode rejection ratio	$V_{IC} = V_{ICRmin},$ $R_S = 50\ \Omega$	25°C	98	115	dB	
		Full range	95			
k_{SVR} Supply-voltage rejection ratio ($\Delta V_{CC\pm}/\Delta V_{IO}$)	$V_{CC\pm} = \pm 4\ \text{V to } \pm 18\ \text{V},$ $R_S = 50\ \Omega$	25°C	94	120	dB	
		Full range	92			
I_{CC} Supply current	$V_O = 0,$ No load	25°C	7.3	10.6	mA	
		Full range	11.2			

† Full range is 0°C to 70°C.

NOTE 4: Typical values are based on the input offset voltage shift observed through 168 hours of operating life test at $T_A = 150^\circ\text{C}$ extrapolated to $T_A = 25^\circ\text{C}$ using the Arrhenius equation and assuming an activation energy of 0.96 eV.

TLE2227, TLE2227Y, TLE2237, TLE2237Y
EXCALIBUR LOW-NOISE HIGH-SPEED
PRECISION DUAL OPERATIONAL AMPLIFIERS

SLOS184 – FEBRUARY 1997

operating characteristics at specified free-air temperature, $V_{CC\pm} = \pm 15\text{ V}$

PARAMETER		TEST CONDITIONS	T_A †	TLE2227C			UNIT
				MIN	TYP	MAX	
SR	Slew rate	$R_L = 2\text{ k}\Omega$, $C_L = 100\text{ pF}$	25°C	1.7	2.5		V/ μ s
			Full range	1.2			
V_n	Equivalent input noise voltage	$R_S = 20\ \Omega$, $f = 10\text{ Hz}$	25°C	3.3		8	nV/ $\sqrt{\text{Hz}}$
		$R_S = 20\ \Omega$, $f = 1\text{ kHz}$		2.5			
$V_{N(PP)}$	Peak-to-peak equivalent input noise voltage	$f = 0.1\text{ Hz to }10\text{ Hz}$	25°C	50	250		nV
I_n	Equivalent input noise current	$f = 10\text{ Hz}$	25°C	1.5		4	pA/ $\sqrt{\text{Hz}}$
		$f = 1\text{ kHz}$		0.4			
THD	Total harmonic distortion	$V_O = \pm 10\text{ V}$, $A_{VD} = 1$, See Note 5	25°C	<0.002%			
B_1	Unity-gain bandwidth	$R_L = 2\text{ k}\Omega$, $C_L = 100\text{ pF}$	25°C	7	13		MHz
B_{OM}	Maximum output-swing bandwidth	$R_L = 2\text{ k}\Omega$	25°C	30			kHz
ϕ_m	Phase margin	$R_L = 2\text{ k}\Omega$, $C_L = 100\text{ pF}$	25°C	40°			

† Full range is 0°C to 70°C.

NOTE 5: Measured distortion of the source used in the analysis is 0.002%.

TLE2227, TLE2227Y, TLE2237, TLE2237Y
EXCALIBUR LOW-NOISE HIGH-SPEED
PRECISION DUAL OPERATIONAL AMPLIFIERS

SLOS184 – FEBRUARY 1997

electrical characteristics at specified free-air temperature, $V_{CC\pm} = \pm 15\text{ V}$ (unless otherwise noted)

PARAMETER	TEST CONDITIONS	T_A^\dagger	TLE2237C			UNIT
			MIN	TYP	MAX	
V_{IO} Input offset voltage	$V_{IC} = 0, R_S = 50\ \Omega$	25°C	100	350		μV
		Full range		500		$\mu\text{V}/^\circ\text{C}$
α_{VIO} Temperature coefficient of input offset voltage		Full range	0.4	1		$\mu\text{V}/\text{mo}$
Input offset voltage long-term drift (see Note 4)		25°C	0.006	1		$\mu\text{V}/\text{mo}$
I_{IO} Input offset current		25°C	7.5	90		nA
		Full range		150		nA
I_{IB} Input bias current		25°C	15	90		nA
		Full range		150		nA
V_{ICR} Common-mode input voltage range	$R_S = 50\ \Omega$	25°C	-11 to 11	-13 to 13		V
		Full range	-10.5 to 10.5			V
V_{OM+} Maximum positive peak output voltage swing	$R_L = 1\ \text{k}\Omega$	25°C	10.5			V
		Full range	10			V
	$R_L = 2\ \text{k}\Omega$	25°C	12			V
		Full range	11			V
V_{OM-} Maximum negative peak output voltage swing	$R_L = 1\ \text{k}\Omega$	25°C	-10.5	-13		V
		Full range	-10			V
	$R_L = 2\ \text{k}\Omega$	25°C	-12	-13.5		V
		Full range	-11			V
A_{VD} Large-signal differential voltage amplification	$V_O = \pm 11\text{ V}, R_L = 2\ \text{k}\Omega$	25°C	2.5	45		V/ μV
		Full range	2			V/ μV
	$V_O = \pm 10\ \text{V}, R_L = 1\ \text{k}\Omega$	25°C	3.5	38		V/ μV
		Full range	1			V/ μV
C_i Input capacitance		25°C	8		pF	
z_O Open-loop output impedance	$I_O = 0$	25°C	50		Ω	
CMRR Common-mode rejection ratio	$V_{IC} = V_{ICRmin}, R_S = 50\ \Omega$	25°C	98	115		dB
		Full range	95			dB
k_{SVR} Supply-voltage rejection ratio ($\Delta V_{CC\pm}/\Delta V_{IO}$)	$V_{CC\pm} = \pm 4\ \text{V to } \pm 18\ \text{V}, R_S = 50\ \Omega$	25°C	94	120		dB
		Full range	92			dB
I_{CC} Supply current	$V_O = 0, \text{ No load}$	25°C	7.3	10.6		mA
		Full range		11.2		mA

† Full range is 0°C to 70°C.

NOTE 4. Typical values are based on the input offset voltage shift observed through 168 hours of operating life test at $T_A = 150^\circ\text{C}$ extrapolated to $T_A = 25^\circ\text{C}$ using the Arrhenius equation and assuming an activation energy of 0.96 eV.



TLE2227, TLE2227Y, TLE2237, TLE2237Y
EXCALIBUR LOW-NOISE HIGH-SPEED
PRECISION DUAL OPERATIONAL AMPLIFIERS

SLOS184 – FEBRUARY 1997

operating characteristics at specified free-air temperature, $V_{CC\pm} = \pm 15\text{ V}$

PARAMETER		TEST CONDITIONS	T_A †	TLE2237C			UNIT
				MIN	TYP	MAX	
SR	Slew rate	$A_{VD} = 5$, $R_L = 2\text{ k}\Omega$, $C_L = 100\text{ pF}$	25°C	4	5		V/ μ s
			Full range	3			
V_n	Equivalent input noise voltage	$R_S = 20\ \Omega$, $f = 10\text{ Hz}$	25°C		3.3	8	nV/ $\sqrt{\text{Hz}}$
					2.5	4.5	
$V_{n(PP)}$	Peak-to-peak equivalent input noise voltage	$f = 0.1\text{ Hz to }10\text{ Hz}$	25°C		50	250	nV
I_n	Equivalent input noise current	$f = 10\text{ Hz}$	25°C		1.5	4	pA/ $\sqrt{\text{Hz}}$
				$f = 1\text{ kHz}$	0.4	0.6	
THD	Total harmonic distortion	$V_O = \pm 10\text{ V}$, $A_{VD} = 5\text{ V}$, See Note 5	25°C	<0.002%			
GBP	Gain-bandwidth product	$f = 100\text{ kHz}$, $R_L = 2\text{ k}\Omega$, $C_L = 100\text{ pF}$	25°C	35	50		MHz
B _{OM}	Maximum output-swing bandwidth	$R_L = 2\text{ k}\Omega$	25°C	80			kHz
ϕ_m	Phase margin	$R_L = 2\text{ k}\Omega$, $C_L = 100\text{ pF}$	25°C	40°			

† Full range is 0°C to 70°C.

NOTE 5. Measured distortion of the source used in the analysis was 0.002%.

TLE2227, TLE2227Y, TLE2237, TLE2237Y EXCALIBUR LOW-NOISE HIGH-SPEED PRECISION DUAL OPERATIONAL AMPLIFIERS

SLOS184 – FEBRUARY 1997

electrical characteristics, $V_{CC\pm} = \pm 15\text{ V}$, $T_A = 25^\circ\text{C}$ (unless otherwise noted)

PARAMETER	TEST CONDITIONS	TLE2227Y			UNIT
		MIN	TYP	MAX	
V_{IO} Input offset voltage	$V_{IC} = 0$, $R_S = 50\ \Omega$		100	350	μV
Input offset voltage long-term drift (see Note 4)			0.006	1	$\mu\text{V}/\text{mo}$
I_{IO} Input offset current			7.5	90	nA
I_{IB} Input bias current			15	90	nA
V_{ICR} Common-mode input voltage range	$R_S = 50\ \Omega$	-11 to 11	-13 to 13		V
V_{OM+} Maximum positive peak output voltage swing	$R_L = 1\ \text{k}\Omega$ $R_L = 2\ \text{k}\Omega$		10.5 12		V
V_{OM-} Maximum negative peak output voltage swing	$R_L = 1\ \text{k}\Omega$ $R_L = 2\ \text{k}\Omega$	-10.5 -12	-13 -13.5		V
A_{VD} Large-signal differential voltage amplification	$V_O = \pm 11\ \text{V}$, $R_L = 2\ \text{k}\Omega$ $V_O = \pm 10\ \text{V}$, $R_L = 1\ \text{k}\Omega$	2.5 3.5	45 38		$\text{V}/\mu\text{V}$
c_i Input capacitance			8		pF
z_o Open-loop output impedance	$I_O = 0$		50		Ω
CMRR Common-mode rejection ratio	$V_{IC} = V_{ICR\text{min}}$, $R_S = 50\ \Omega$	98	115		dB
k_{SVR} Supply-voltage rejection ratio ($\Delta V_{CC\pm}/\Delta V_{IO}$)	$V_{CC\pm} = \pm 4\ \text{V}$ to $\pm 18\ \text{V}$, $R_S = 50\ \Omega$	94	120		dB
I_{CC} Supply current	$V_O = 0$, No load	7.3	10.6		mA

NOTE 4. Typical values are based on the input offset voltage shift observed through 168 hours of operating life test at $T_A = 150^\circ\text{C}$ extrapolated to $T_A = 25^\circ\text{C}$ using the Arrhenius equation and assuming an activation energy of 0.96 eV.

operating characteristics, $V_{CC\pm} = \pm 15\ \text{V}$, $T_A = 25^\circ\text{C}$

PARAMETER	TEST CONDITIONS	TLE2227Y			UNIT
		MIN	TYP	MAX	
SR Slew rate	$R_L = 2\ \text{k}\Omega$, $C_L = 100\ \text{pF}$	1.7	2.5		$\text{V}/\mu\text{s}$
V_n Equivalent input noise voltage	$R_S = 20\ \Omega$, $f = 10\ \text{Hz}$ $R_S = 20\ \Omega$, $f = 1\ \text{kHz}$		3.3 2.5	8 4.5	$\text{nV}/\sqrt{\text{Hz}}$
$V_{N(PP)}$ Peak-to-peak equivalent input noise voltage	$f = 0.1\ \text{Hz}$ to $10\ \text{Hz}$		50	250	nV
I_n Equivalent input noise current	$f = 10\ \text{Hz}$ $f = 1\ \text{kHz}$		1.5 0.4	4 0.6	$\text{pA}/\sqrt{\text{Hz}}$
THD Total harmonic distortion	$V_O = \pm 10\ \text{V}$, $A_{VD} = 1$, See Note 5		<0.002%		
B_1 Unity-gain bandwidth	$R_L = 2\ \text{k}\Omega$, $C_L = 100\ \text{pF}$	7	13		MHz
B_{OM} Maximum output-swing bandwidth	$R_L = 2\ \text{k}\Omega$		30		kHz
ϕ_m Phase margin	$R_L = 2\ \text{k}\Omega$, $C_L = 100\ \text{pF}$		40°		

NOTE 5 Measured distortion of the source used in the analysis is 0.002%.



TLE2227, TLE2227Y, TLE2237, TLE2237Y
EXCALIBUR LOW-NOISE HIGH-SPEED
PRECISION DUAL OPERATIONAL AMPLIFIERS

SLOS184 – FEBRUARY 1997

electrical characteristics at specified free-air temperature $V_{CC\pm} = \pm 15$ V (unless otherwise noted)

PARAMETER		TEST CONDITIONS	TLE2237Y			UNIT
			MIN	TYP	MAX	
V_{IO}	Input offset voltage	$V_{IC} = 0,$ $R_S = 50 \Omega$		100	350	μ V
	Input offset voltage long-term drift (see Note 4)			0.006	1	μ V/mo
I_{IO}	Input offset current			7.5	90	nA
I_{IB}	Input bias current			15	90	nA
V_{ICR}	Common-mode input voltage range	$R_S = 50 \Omega$	-11 to 11	-13 to 13		V
V_{OM+}	Maximum positive peak output voltage swing	$R_L = 1$ k Ω	10.5			V
		$R_L = 2$ k Ω	12			
V_{OM-}	Maximum negative peak output voltage swing	$R_L = 1$ k Ω	-10.5	-13		V
		$R_L = 2$ k Ω	-12	-13.5		
A_{VD}	Large-signal differential voltage amplification	$V_O = \pm 11$ V, $R_L = 2$ k Ω	2.5	45		V/ μ V
		$V_O = \pm 10$ V, $R_L = 1$ k Ω	3.5	38		
C_i	Input capacitance		8			pF
z_O	Open-loop output impedance	$I_O = 0$	50			Ω
CMRR	Common-mode rejection ratio	$V_{IC} = V_{ICRmin},$ $R_S = 50 \Omega$	98	115		dB
k_{SVR}	Supply-voltage rejection ratio ($\Delta V_{CC\pm}/\Delta V_{IO}$)	$V_{CC\pm} = \pm 4$ V to ± 18 V, $R_S = 50 \Omega$	94	120		dB
I_{CC}	Supply current	$V_O = 0,$ No load	7.3	10.6		mA

NOTE 4. Typical values are based on the input offset voltage shift observed through 168 hours of operating life test at $T_A = 150^\circ\text{C}$ extrapolated to $T_A = 25^\circ\text{C}$ using the Arrhenius equation and assuming an activation energy of 0.96 eV.

operating characteristics at specified free-air temperature $V_{CC\pm} = \pm 15$ V

PARAMETER		TEST CONDITIONS	TLE2237Y			UNIT
			MIN	TYP	MAX	
SR	Slew rate	$R_L = 2$ k $\Omega,$ $C_L = 100$ pF	4	5		V/ μ s
V_n	Equivalent input noise voltage	$R_S = 20 \Omega,$ $f = 10$ Hz		3.3	8	nV/ $\sqrt{\text{Hz}}$
		$R_S = 20 \Omega,$ $f = 1$ kHz		2.5	4.5	
$V_{n(PP)}$	Peak-to-peak equivalent input noise voltage	$f = 0.1$ Hz to 10 Hz		50	250	nV
I_n	Equivalent input noise current	$f = 10$ Hz		1.5	4	pA/ $\sqrt{\text{Hz}}$
		$f = 1$ kHz		0.4	0.6	
THD	Total harmonic distortion	$V_O = \pm 10$ V, $A_{VD} = 1,$ See Note 5	<0.002%			
B_1	Unity-gain bandwidth	$R_L = 2$ k $\Omega,$ $C_L = 100$ pF	35	50		MHz
B_{OM}	Maximum output-swing bandwidth	$R_L = 2$ k Ω	80			kHz
ϕ_m	Phase margin	$R_L = 2$ k $\Omega,$ $C_L = 100$ pF	40 $^\circ$			

NOTE 5. Measured distortion of the source used in the analysis is 0.002%.



PARAMETER MEASUREMENT INFORMATION

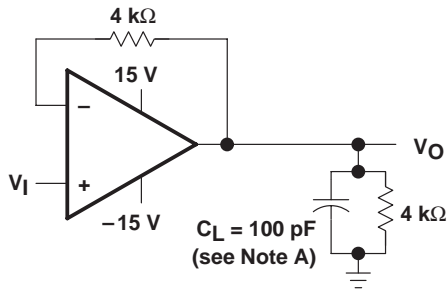

NOTE A: C_L includes fixture capacitance.

Figure 1. Slew-Rate Test Circuit

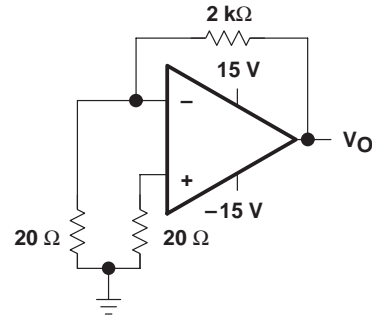
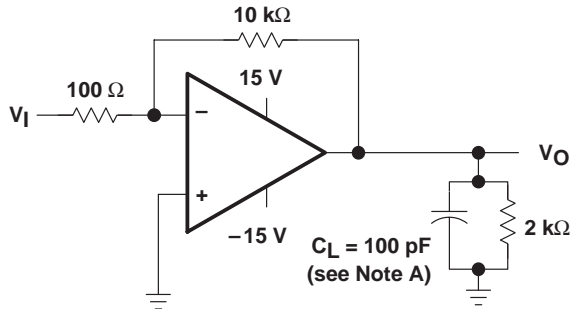
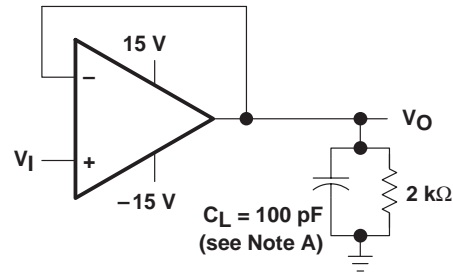

Figure 2. Noise-Voltage Test Circuit



NOTE A: C_L includes fixture capacitance.

Figure 3. Unity-Gain Bandwidth and Phase-Margin Test Circuit



NOTE A: C_L includes fixture capacitance.

Figure 4. Small-Signal Pulse-Response Test Circuit

TYPICAL CHARACTERISTICS

Table of Graphs

			FIGURE
V_{IO}	Input offset voltage	Distribution	5
ΔV_{IO}	Input offset voltage change	vs Time after power on	6, 7
I_{IO}	Input offset current	vs Free-air temperature	8
I_{IB}	Input bias current	vs Common-mode input voltage vs Free-air temperature	9 10
I_I	Input current	vs Differential input voltage	11
$V_{O(PP)}$	Maximum peak-to-peak output voltage	vs Frequency	12
V_{OM}	Maximum peak positive output voltage	vs Load resistance vs Free-air temperature	13 15
V_{OM}	Maximum peak negative output voltage	vs Load resistance vs Free-air temperature	14 16
A_{VD}	Large-signal differential voltage amplification	vs Supply voltage vs Load resistance vs Frequency vs Free-air temperature	17 19 18, 20, 21 22
z_o	Output impedance	vs Frequency	23
CMRR	Common-mode rejection ratio	vs Frequency	24
kSVR	Supply-voltage rejection ratio	vs Frequency	25
I_{OS}	Short-circuit output current	vs Supply voltage vs Elapsed time vs Free-air temperature	26, 27 28, 29 30, 31
I_{CC}	Supply current	vs Supply voltage vs Free-air temperature	32 33
	Voltage-follower small-signal pulse response	vs Time	34, 35
	Voltage-follower large-signal pulse response	vs Time	36, 37
V_n	Equivalent input noise voltage	vs Frequency	38
	Noise voltage (referred to input)	Over 10-second interval	39
B_1	Unity-gain bandwidth	vs Supply voltage vs Load capacitance	40, 41 42, 43
SR	Slew rate	vs Free-air temperature	44, 45
ϕ_m	Phase margin	vs Supply voltage vs Load capacitance	46 47, 48
	Phase shift	vs Frequency	18, 20, 21

TYPICAL CHARACTERISTICS

DISTRIBUTION OF
 INPUT OFFSET VOLTAGE

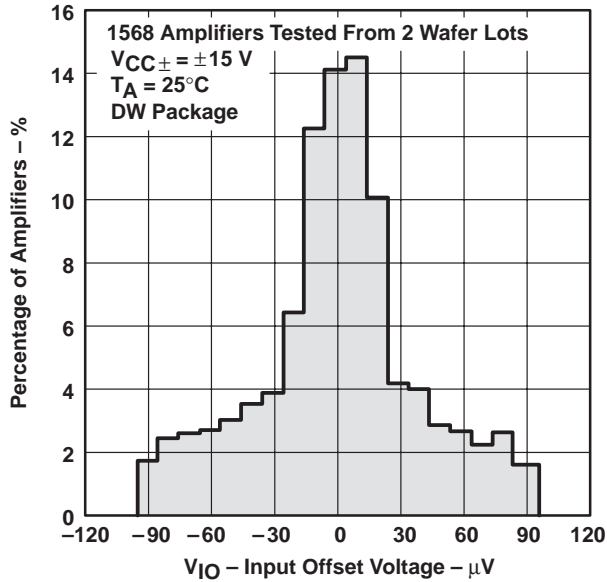

Figure 5

INPUT OFFSET VOLTAGE CHANGE
 vs
 TIME AFTER POWER ON

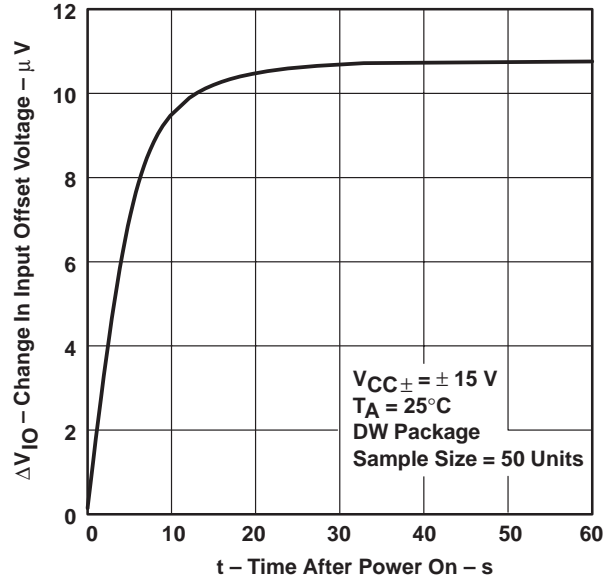

Figure 6

INPUT OFFSET VOLTAGE CHANGE
 vs
 TIME AFTER POWER ON

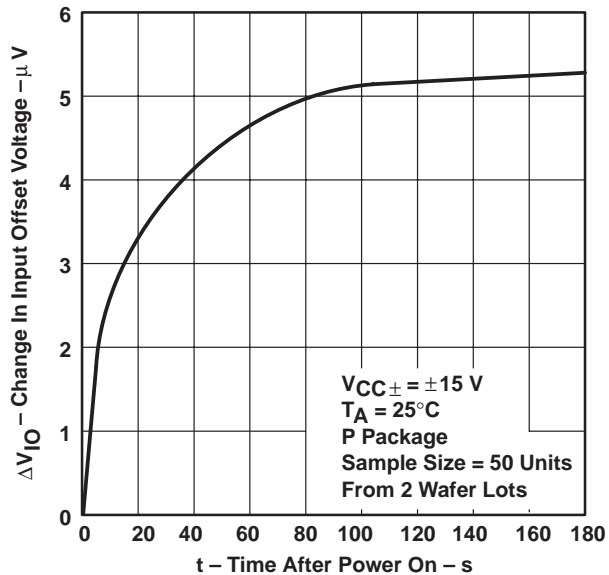

Figure 7

INPUT OFFSET CURRENT
 vs
 FREE-AIR TEMPERATURE

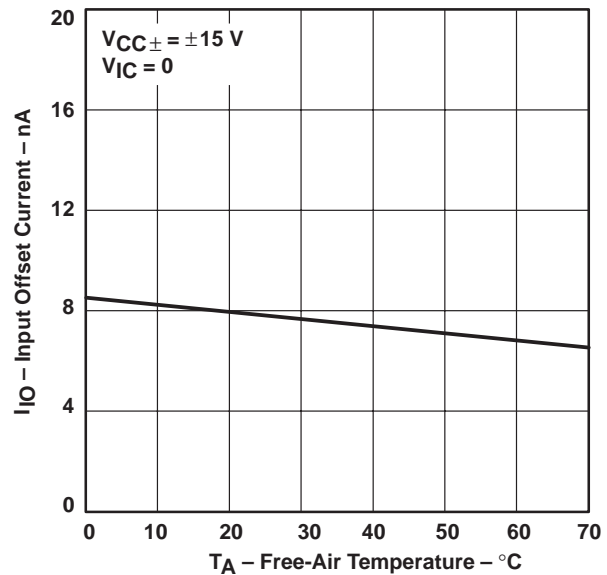

Figure 8

TYPICAL CHARACTERISTICS

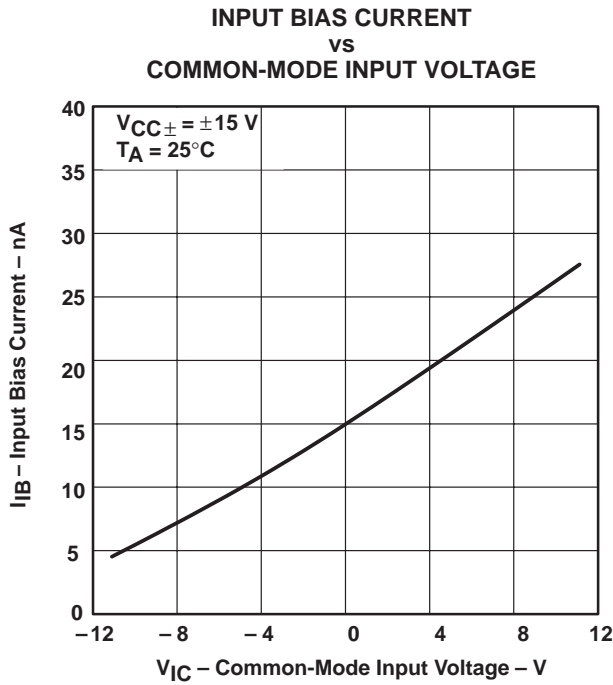

Figure 9

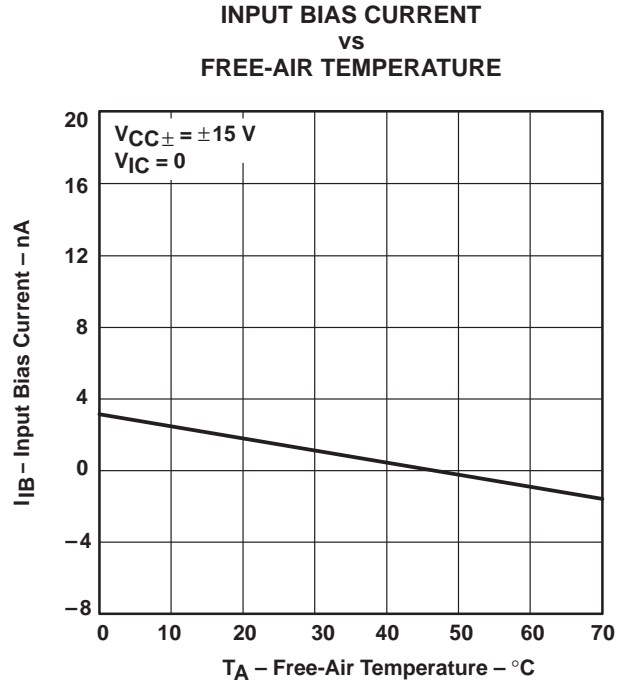

Figure 10

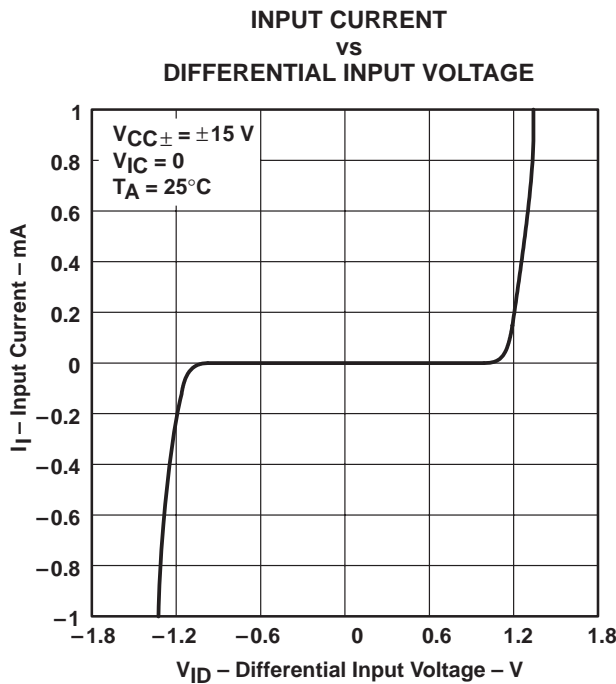

Figure 11

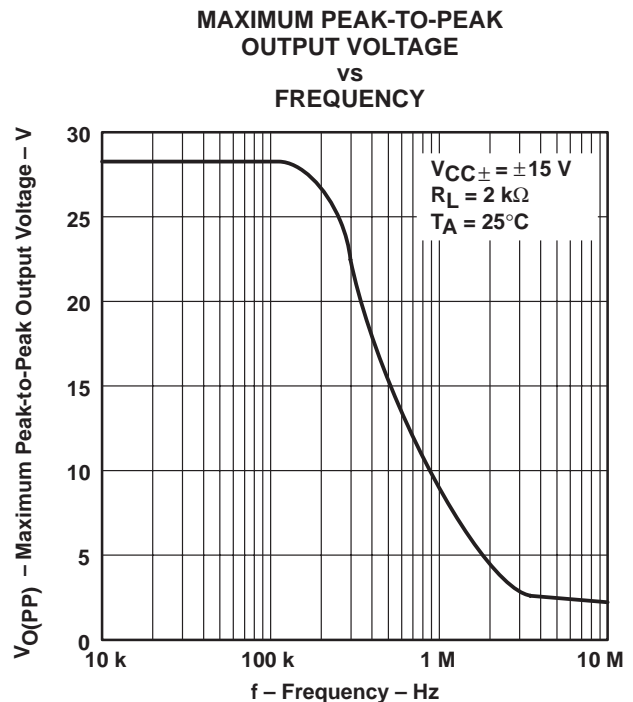

Figure 12

TYPICAL CHARACTERISTICS

MAXIMUM POSITIVE PEAK
 OUTPUT VOLTAGE
 VS
 LOAD RESISTANCE

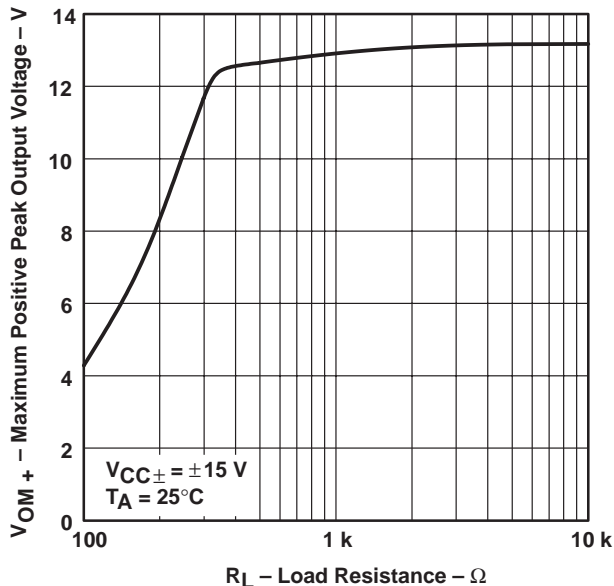

Figure 13

MAXIMUM NEGATIVE PEAK
 OUTPUT VOLTAGE
 VS
 LOAD RESISTANCE

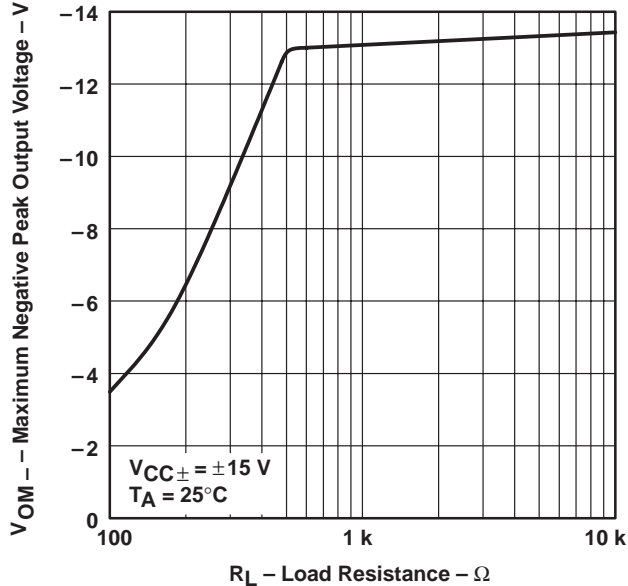

Figure 14

MAXIMUM POSITIVE PEAK
 OUTPUT VOLTAGE
 VS
 FREE-AIR TEMPERATURE

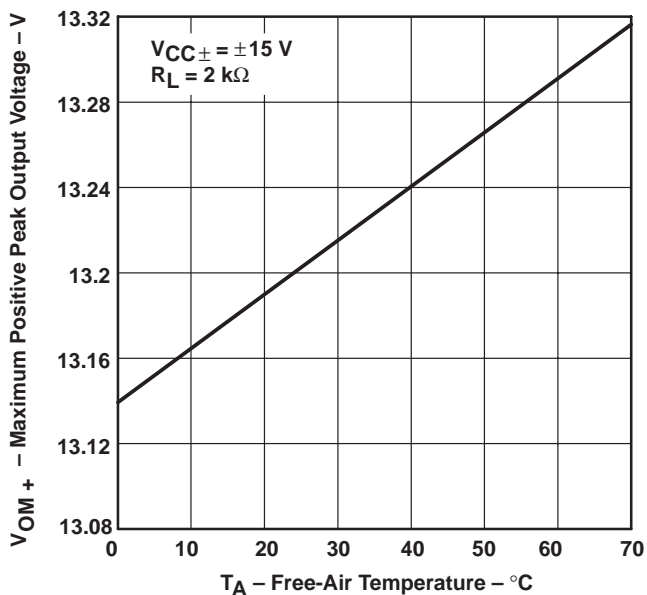

Figure 15

MAXIMUM NEGATIVE PEAK
 OUTPUT VOLTAGE
 VS
 FREE-AIR TEMPERATURE

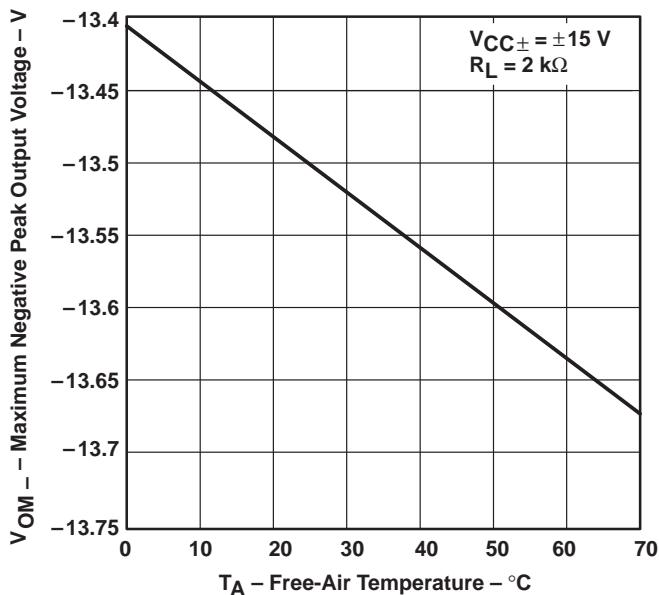

Figure 16

TYPICAL CHARACTERISTICS

LARGE-SIGNAL DIFFERENTIAL
 VOLTAGE AMPLIFICATION

vs
 SUPPLY VOLTAGE

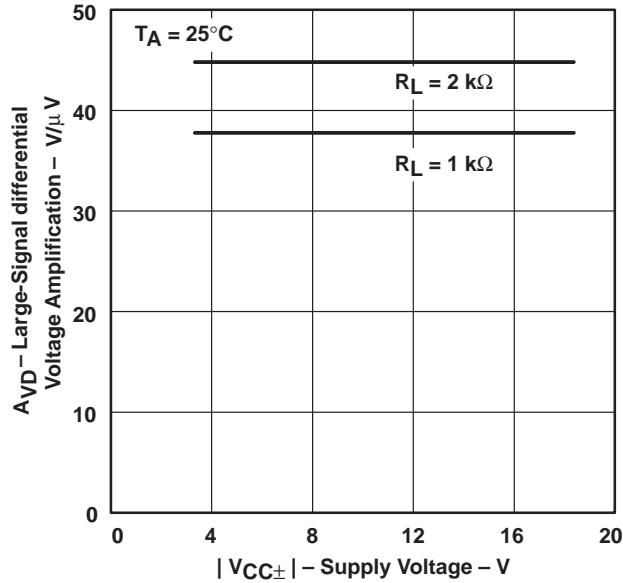

Figure 17

LARGE-SIGNAL DIFFERENTIAL VOLTAGE
 AMPLIFICATION AND PHASE SHIFT

vs
 FREQUENCY

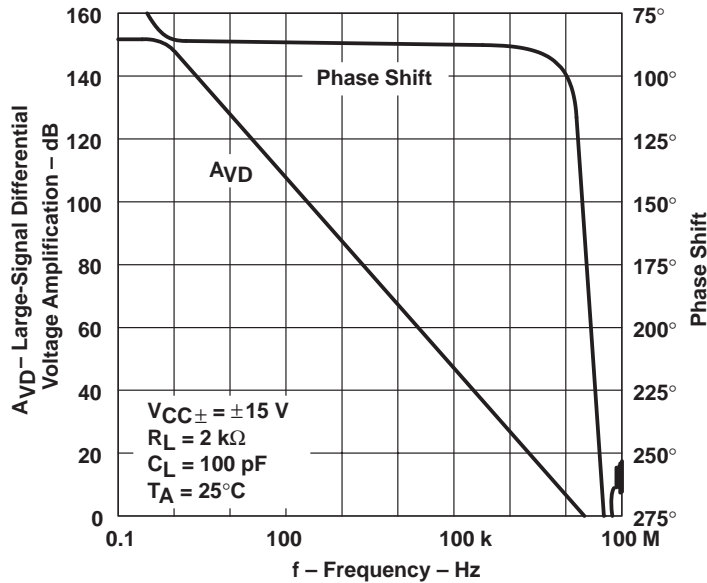

Figure 18

TYPICAL CHARACTERISTICS

LARGE-SIGNAL DIFFERENTIAL
 VOLTAGE AMPLIFICATION
 vs
 LOAD RESISTANCE

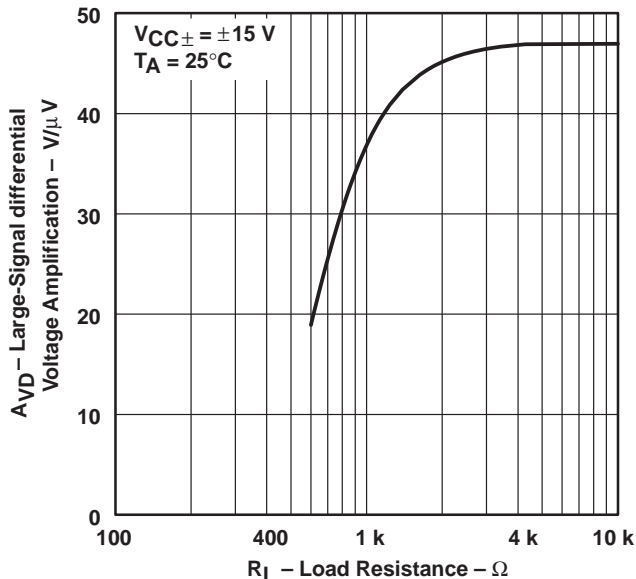

Figure 19

TLE2227
 LARGE-SIGNAL DIFFERENTIAL VOLTAGE
 AMPLIFICATION AND PHASE SHIFT
 vs
 FREQUENCY

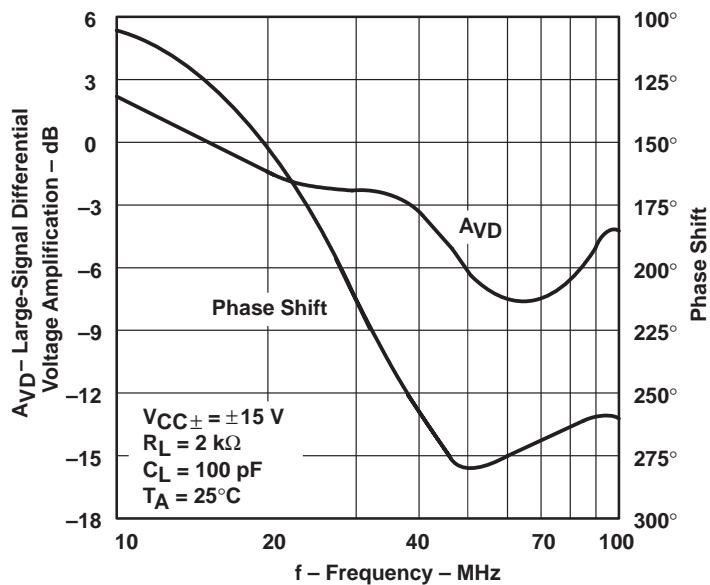

Figure 20

TYPICAL CHARACTERISTICS

TLE2037
 LARGE-SIGNAL DIFFERENTIAL VOLTAGE
 AMPLIFICATION AND PHASE SHIFT
 VS
 FREQUENCY

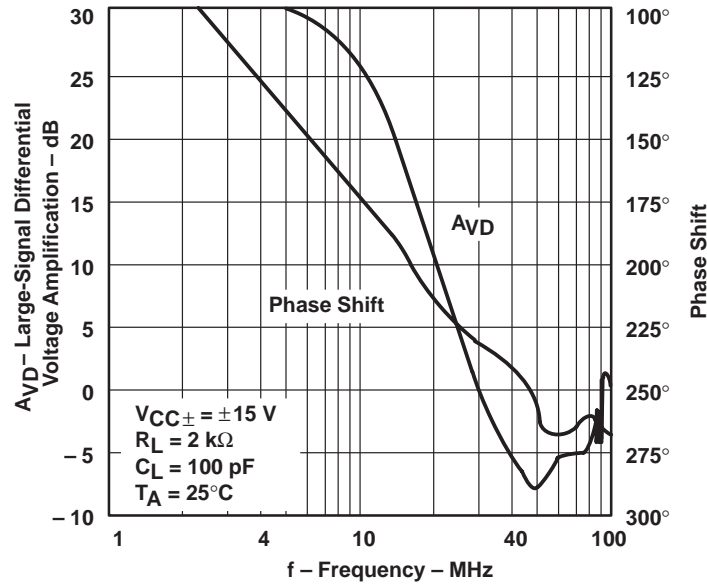

Figure 21

LARGE-SCALE DIFFERENTIAL
 VOLTAGE AMPLIFICATION
 VS
 FREE-AIR TEMPERATURE

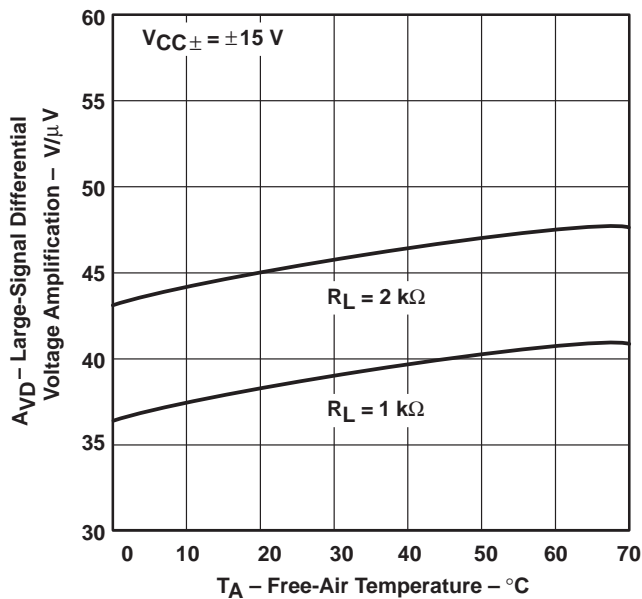

Figure 22

OUTPUT IMPEDANCE
 VS
 FREQUENCY

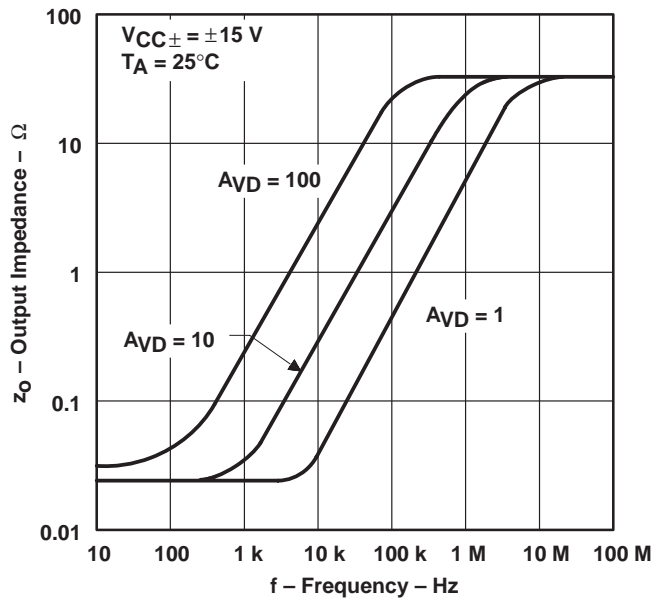

Figure 23

TYPICAL CHARACTERISTICS

COMMON-MODE REJECTION RATIO
 VS
 FREQUENCY

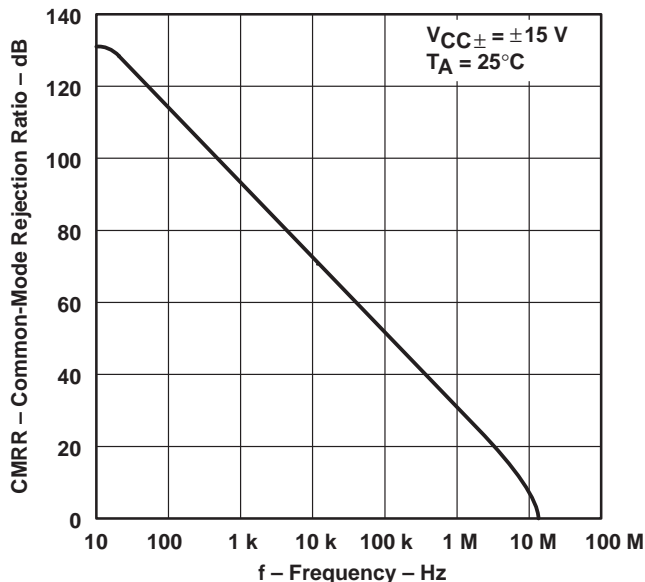

Figure 24

SUPPLY-VOLTAGE REJECTION RATIO
 VS
 FREQUENCY

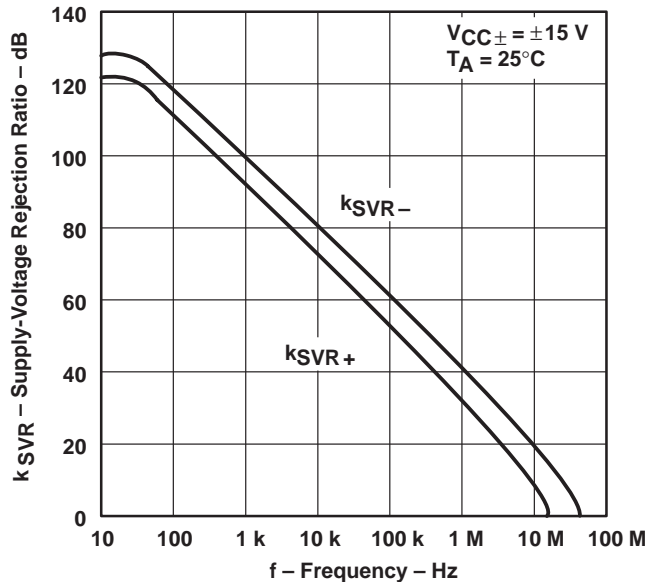

Figure 25

SHORT-CIRCUIT OUTPUT CURRENT
 VS
 SUPPLY VOLTAGE

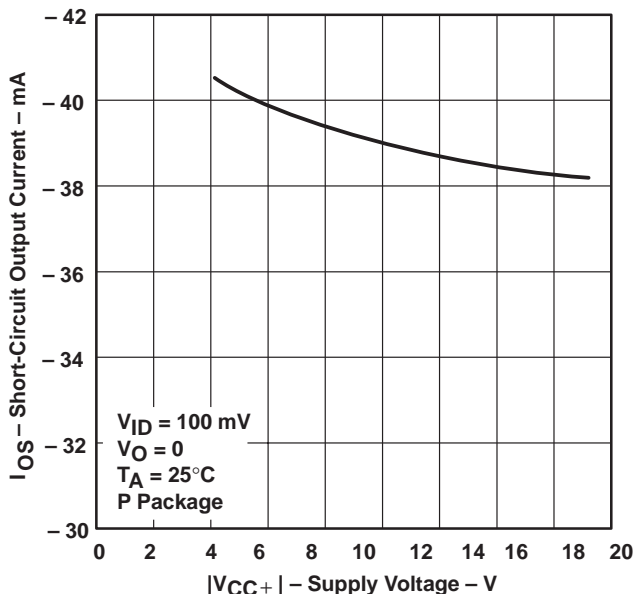

Figure 26

SHORT-CIRCUIT OUTPUT CURRENT
 VS
 SUPPLY VOLTAGE

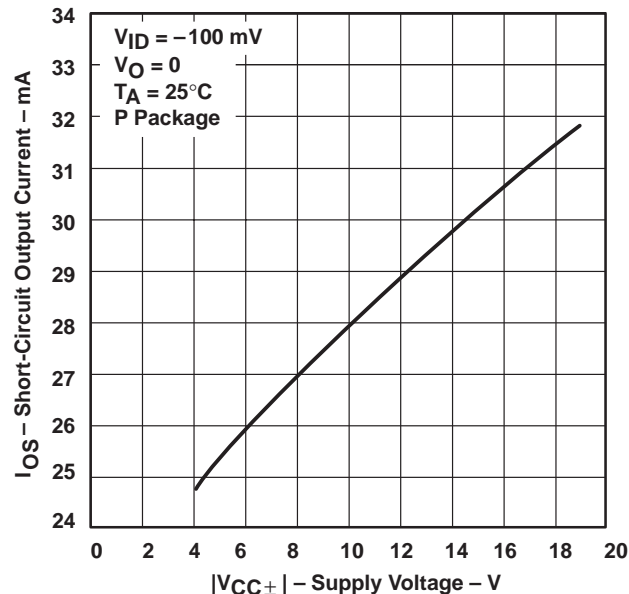

Figure 27

TYPICAL CHARACTERISTICS

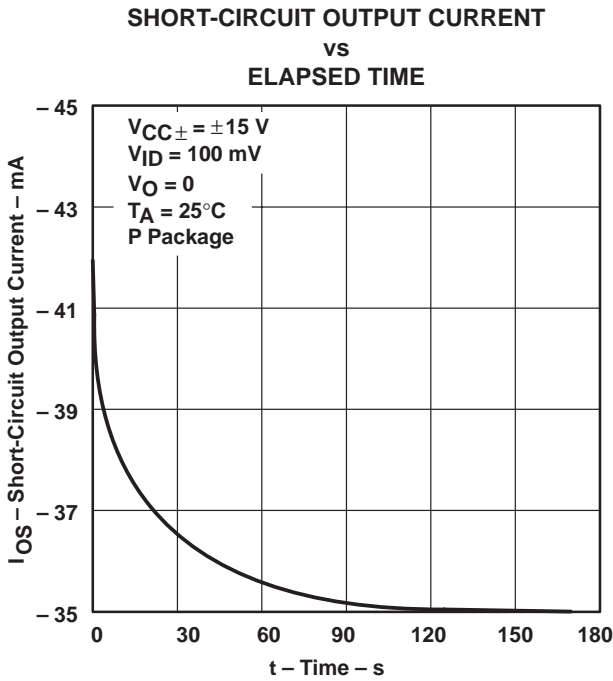

Figure 28

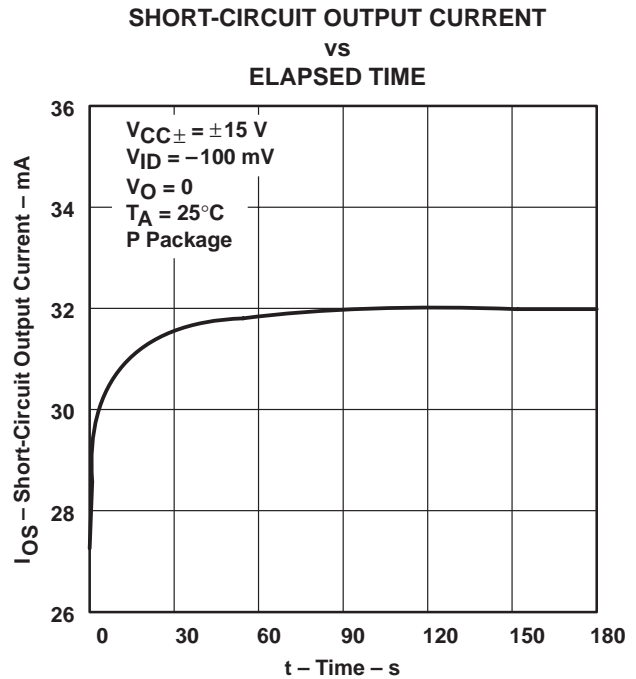

Figure 29

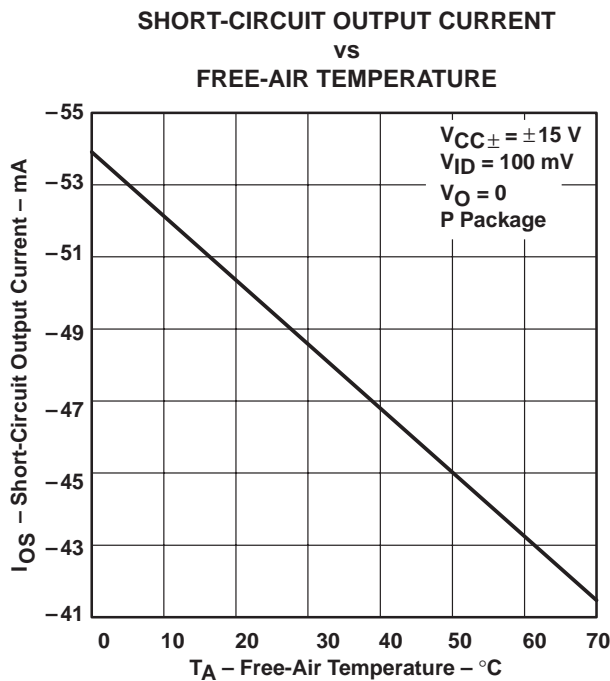

Figure 30

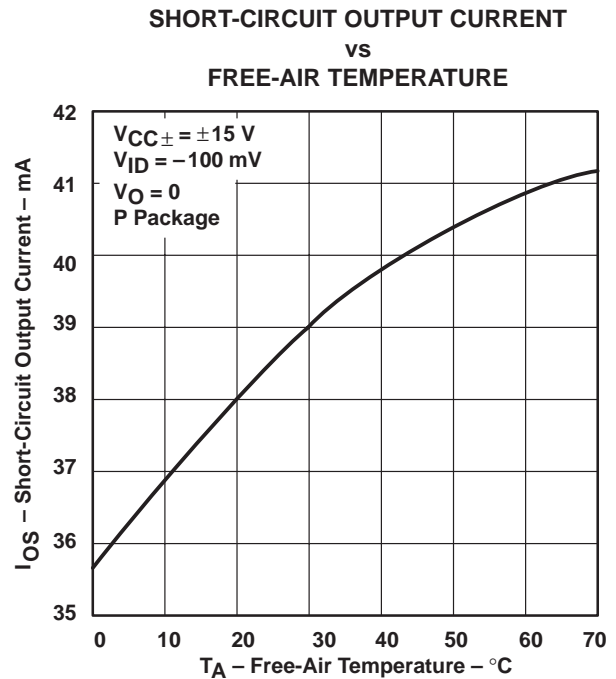

Figure 31

TYPICAL CHARACTERISTICS

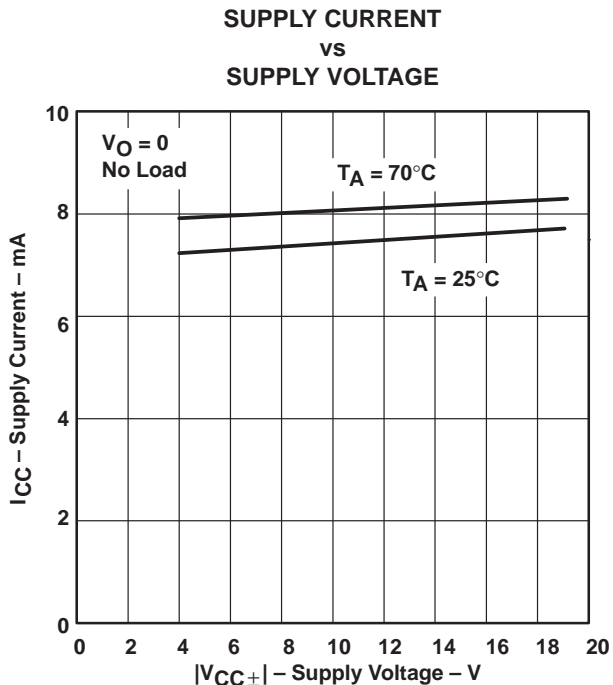

Figure 32

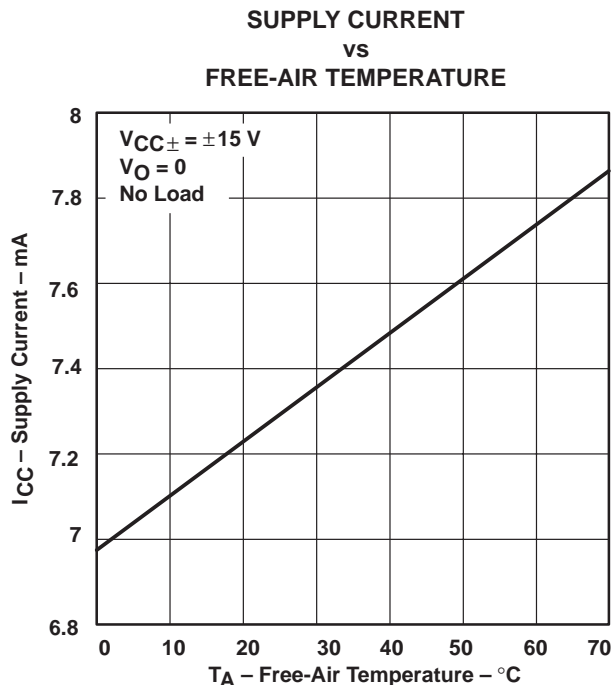

Figure 33

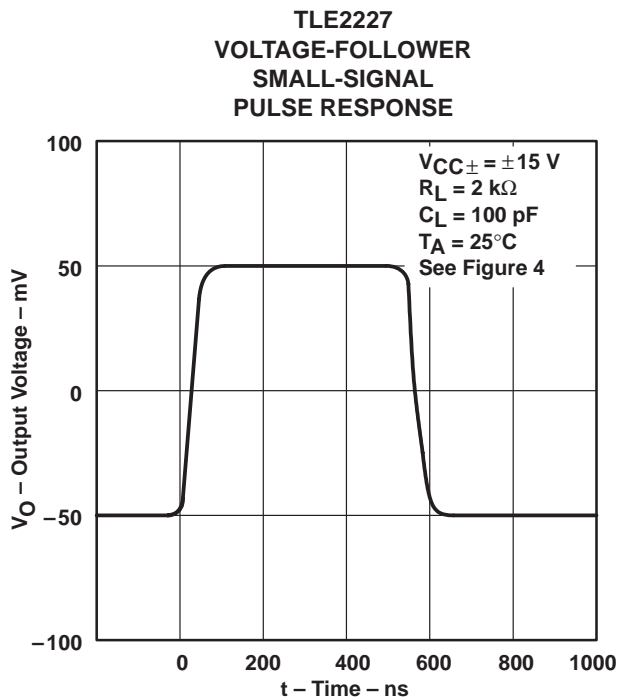

Figure 34

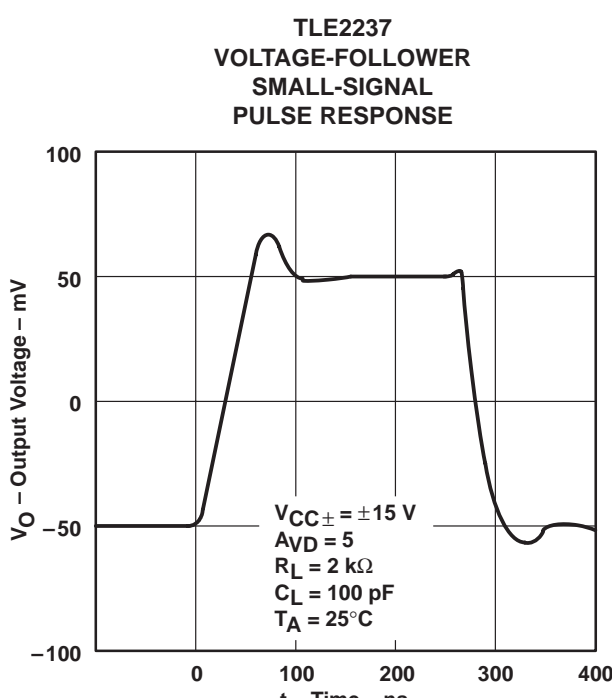

Figure 35

TYPICAL CHARACTERISTICS

TLE2227
 VOLTAGE-FOLLOWER
 LARGE-SIGNAL
 PULSE RESPONSE

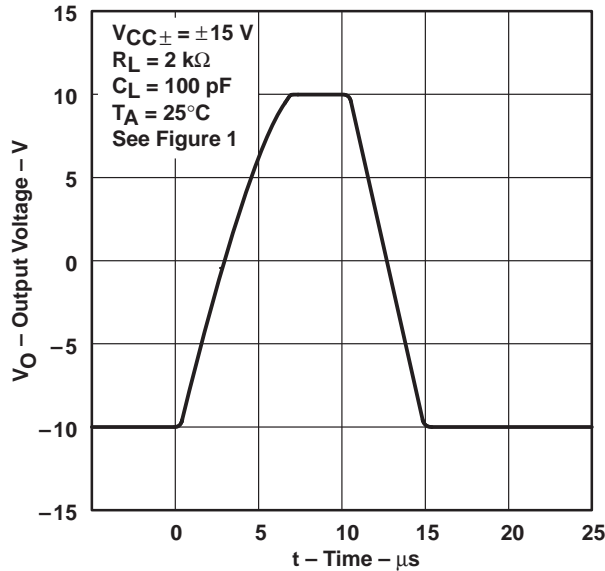

Figure 36

TLE2237
 VOLTAGE-FOLLOWER
 LARGE-SIGNAL
 PULSE RESPONSE

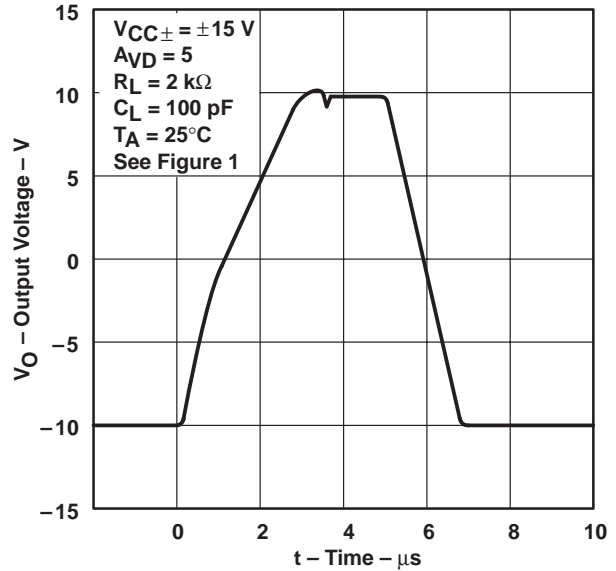

Figure 37

EQUIVALENT INPUT NOISE VOLTAGE
 vs
 FREQUENCY

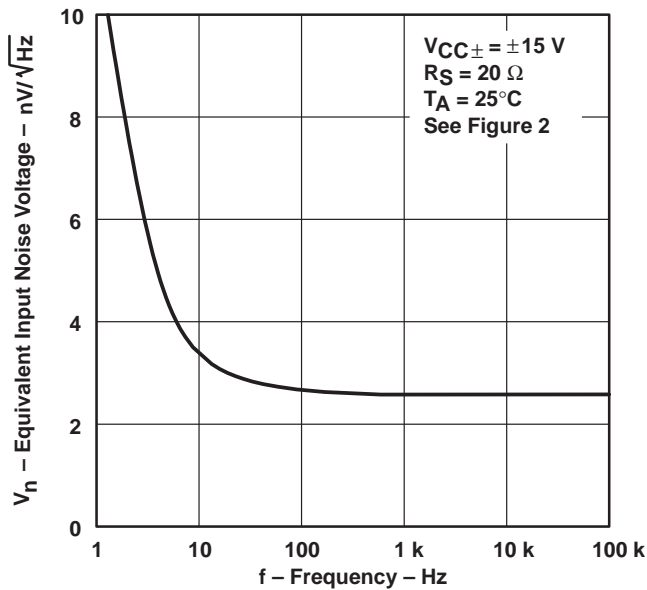

Figure 38

NOISE VOLTAGE
 (REFERRED TO INPUT)
 OVER A 10-SECOND INTERVAL

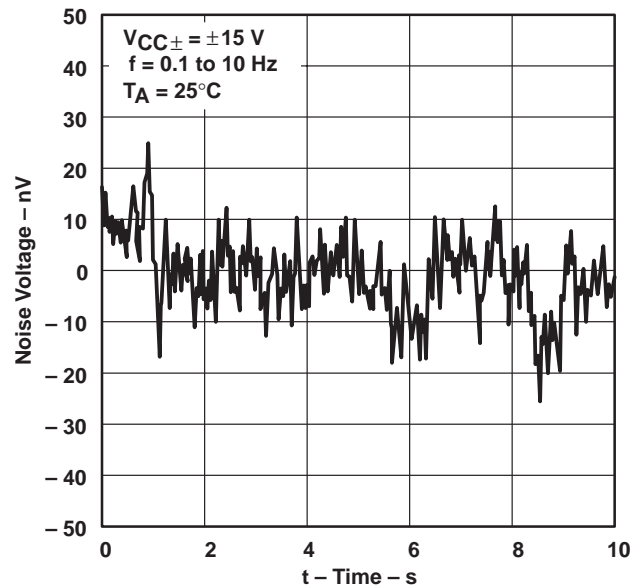

Figure 39

TYPICAL CHARACTERISTICS

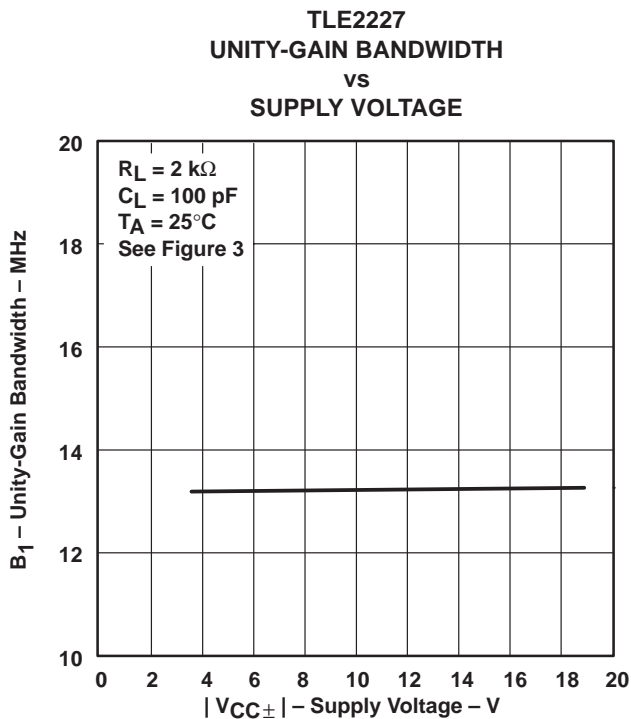

Figure 40

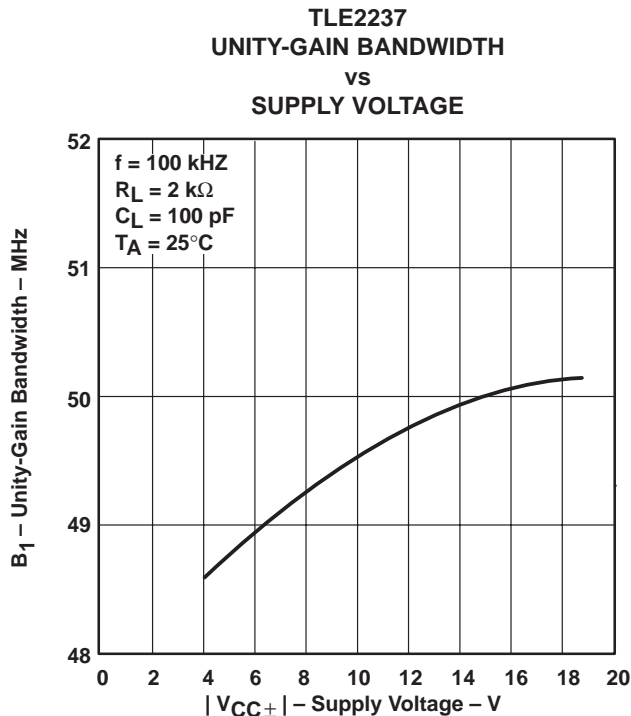

Figure 41

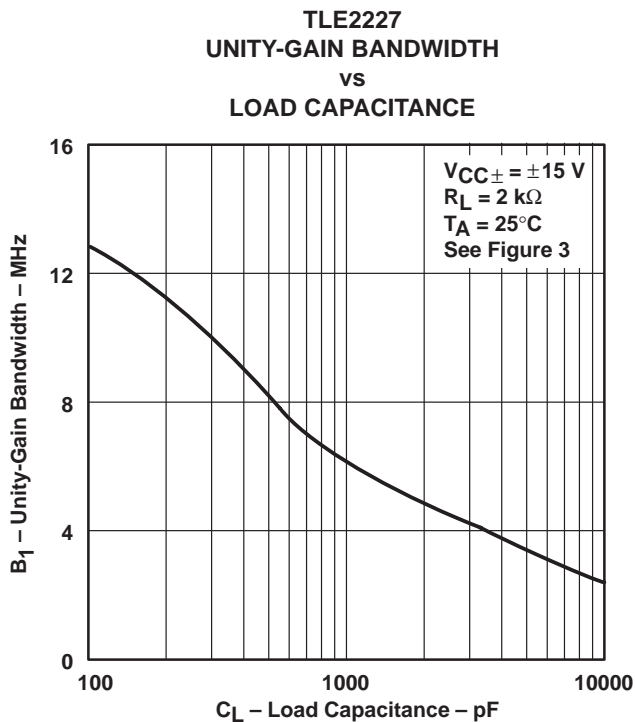

Figure 42

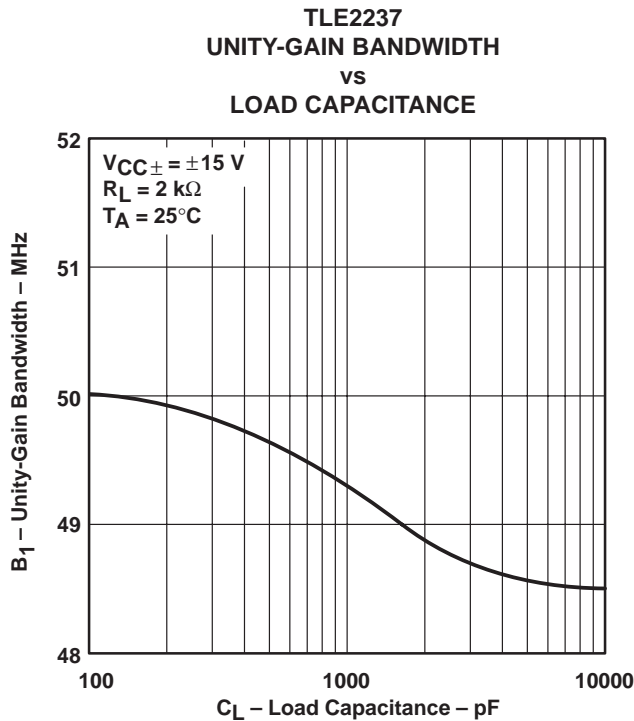

Figure 43

TYPICAL CHARACTERISTICS

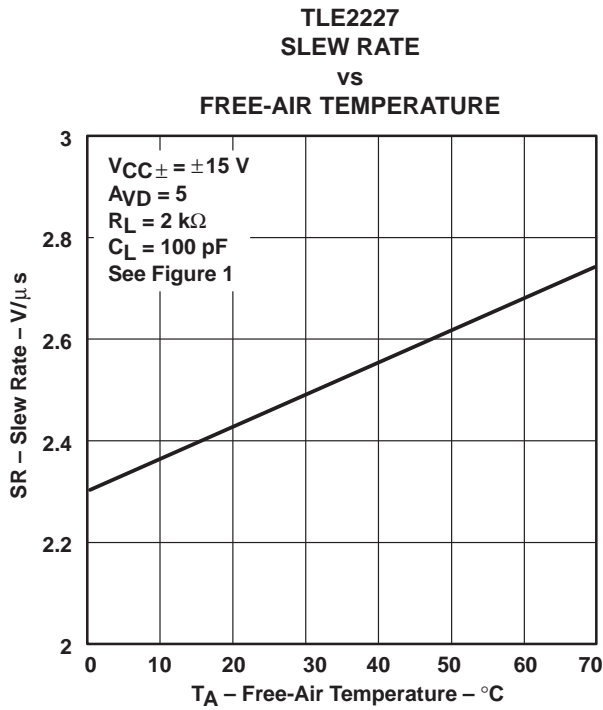

Figure 44

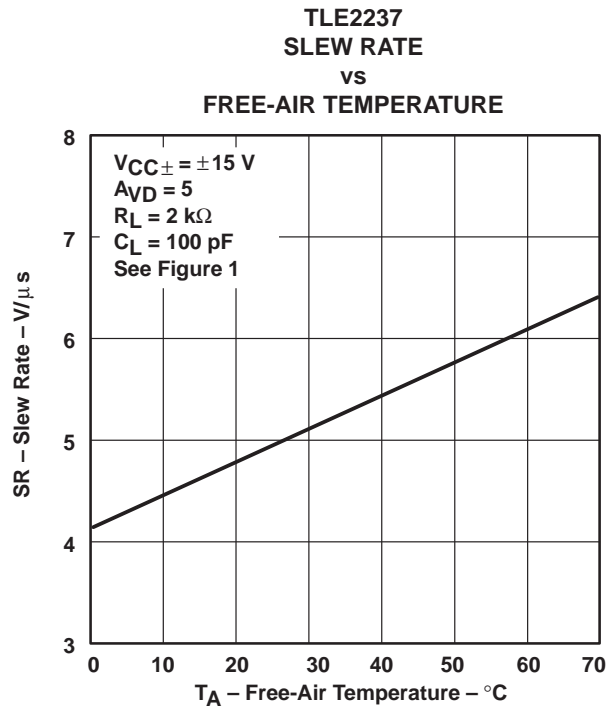

Figure 45

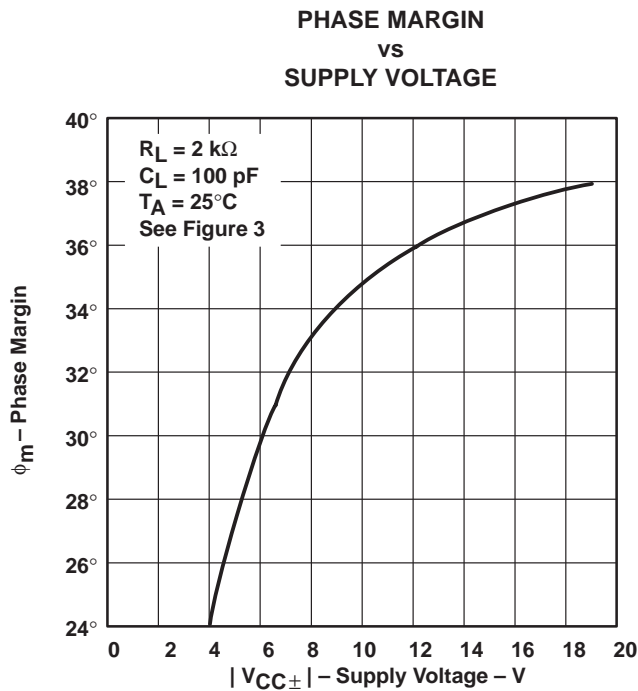

Figure 46

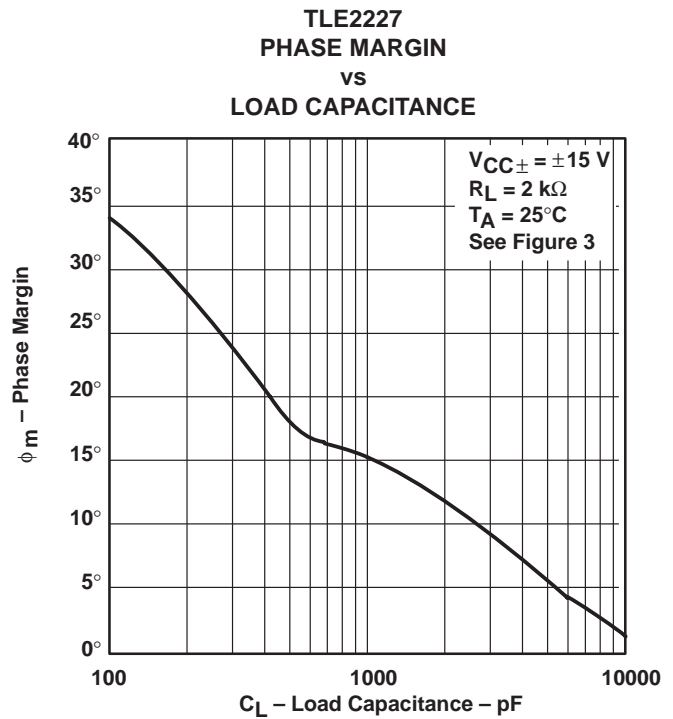

Figure 47

TLE2227, TLE2227Y, TLE2237, TLE2237Y EXCALIBUR LOW-NOISE HIGH-SPEED PRECISION DUAL OPERATIONAL AMPLIFIERS

SLOS184 – FEBRUARY 1997

TYPICAL CHARACTERISTICS

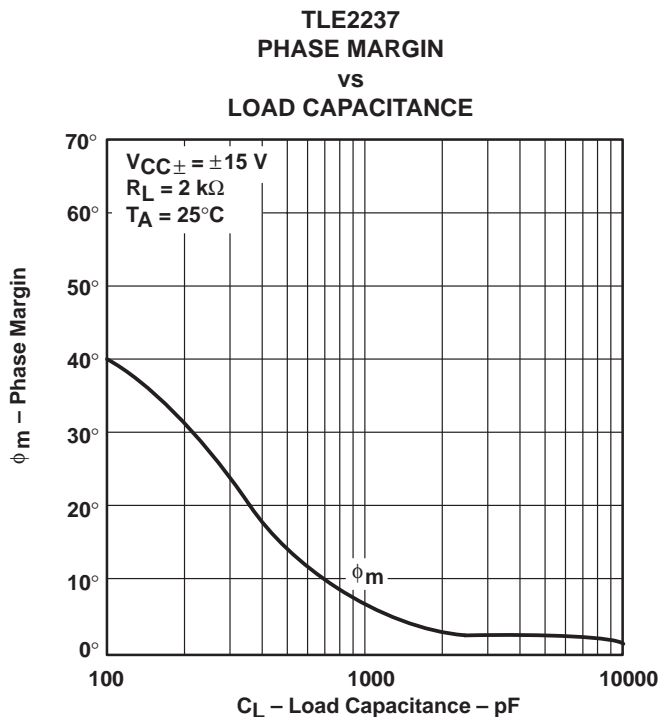

Figure 48

APPLICATION INFORMATION

TLE2227 macromodel information

Macromodel information provided was derived using Microsim *Parts*[™], the model generation software used with Microsim *PSPice*[™]. The Boyle macromodel (see Note 6) and subcircuit in Figure 49 and Figure 50 are generated using the TLE2227C typical electrical and operating characteristics at 25°C. Using this information, output simulations of the following key parameters can be generated to a tolerance of 20% (in most cases):

- Maximum positive output voltage swing
- Maximum negative output voltage swing
- Slew rate
- Quiescent power dissipation
- Input bias current
- Open-loop voltage amplification
- Unity-gain bandwidth
- Common-mode rejection ratio
- Phase margin
- DC output resistance
- AC output resistance
- Short-circuit output current limit

NOTE 6: G. R. Boyle, B. M. Cohn, D. O. Pederson, and J. E. Solomon, "Macromodeling of Integrated Circuit Operational Amplifiers", *IEEE Journal of Solid-State Circuits*, SC-9, 353 (1974).

PSPice and *Parts* are trademarks of MicroSim Corporation.

Macromodels, simulation models, or other models provided by TI, directly or indirectly, are not warranted by TI as fully representing all of the specification and operating characteristics of the semiconductor product to which the model relates.



POST OFFICE BOX 655303 • DALLAS, TEXAS 75265

APPLICATION INFORMATION

TLE2227 macromodel information (continued)

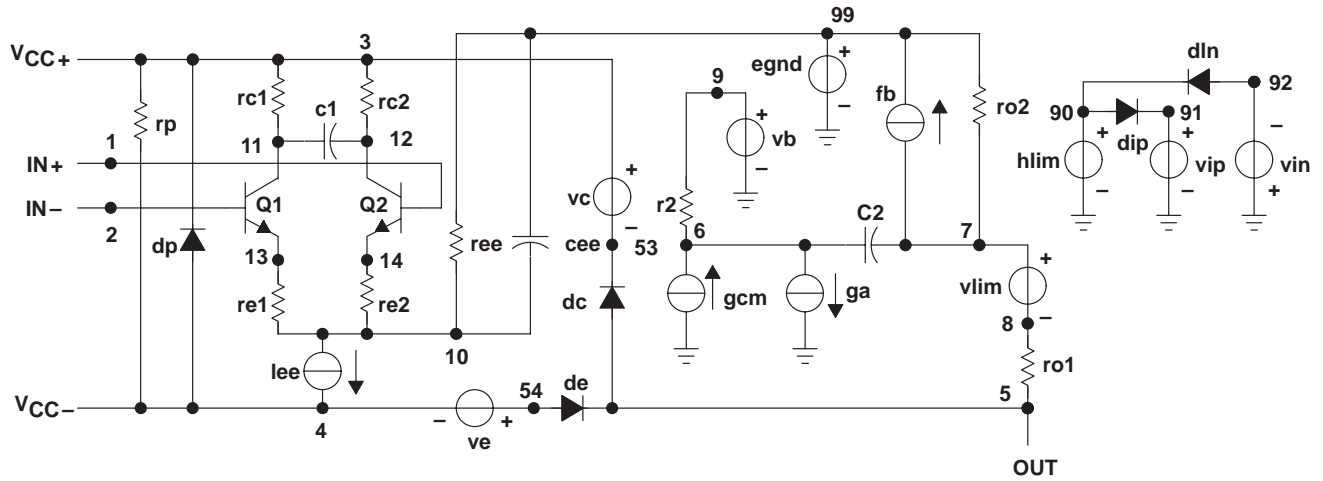

Figure 49. Boyle Macromodel

```
.subckt TLE2227 1 2 3 4 5
*
c1 11 12 4.003E-12
c2 6 7 20.00E-12
dc 5 53 dx
de 54 5 dx
dip 90 91 dx
dln 92 90 dx
dp 4 3 dx
egnd 99 0 poly(2) (3,0) (4,0) 0 .5 .5
fb 7 99 poly(5) vb vc ve vlp vln 0 954.8E6 -1E9 1E9 1E9 -1E9
ga 6 0 11 12 2.062E-3
gcm 0 6 10 99 531.3E-12
iee 10 4 dc 56.01E-6
hlim 90 0 vlim 1K
q1 11 2 13 qx
q2 12 1 14 qx
r2 6 9 100.0E3
rc1 3 11 530.5
rc2 3 12 530.5
re1 13 10 -393.2
re2 14 10 -393.2
ree 10 99 3.571E6
ro1 8 5 25
ro2 7 99 25
rp 3 4 8.013E3
vb 9 0 dc 0
vc 3 53 dc 2.400
ve 54 4 dc 2.100
vlim 7 8 dc 0
vlp 91 0 dc 40
vln 0 92 dc 40
.model dx D(Is=800.0E-18)
.model qx NPN(Is=800.0E-18 Bf=7.000E3)
.ends
```

Figure 50. TLE2227 Macromodel Subcircuit

TLE2227, TLE2227Y, TLE2237, TLE2237Y EXCALIBUR LOW-NOISE HIGH-SPEED PRECISION DUAL OPERATIONAL AMPLIFIERS

SLOS184 – FEBRUARY 1997

TLE2037 macromodel information

Macromodel information provided is derived using *PSpice™ Parts™* model generation software. The Boyle macromodel (see Note 6) and subcircuit in Figure 51 and Figure 52 are generated using the TLE2237C typical electrical and operating characteristics at 25°C. Using this information, output simulations of the following key parameters can be generated to a tolerance of 20% (in most cases):

- Maximum positive output voltage swing
- Maximum negative output voltage swing
- Slew rate
- Quiescent power dissipation
- Input bias current
- Open-loop voltage amplification
- Unity-gain bandwidth
- Common-mode rejection ratio
- Phase margin
- DC output resistance
- AC output resistance
- Short-circuit output current limit

NOTE 6. G. R. Boyle, B. M. Cohn, D. O. Pederson, and J. E. Solomon, "Macromodeling of Integrated Circuit Operational Amplifiers," *IEEE Journal of Solid-State Circuits*, SC-9, 353 (1974).

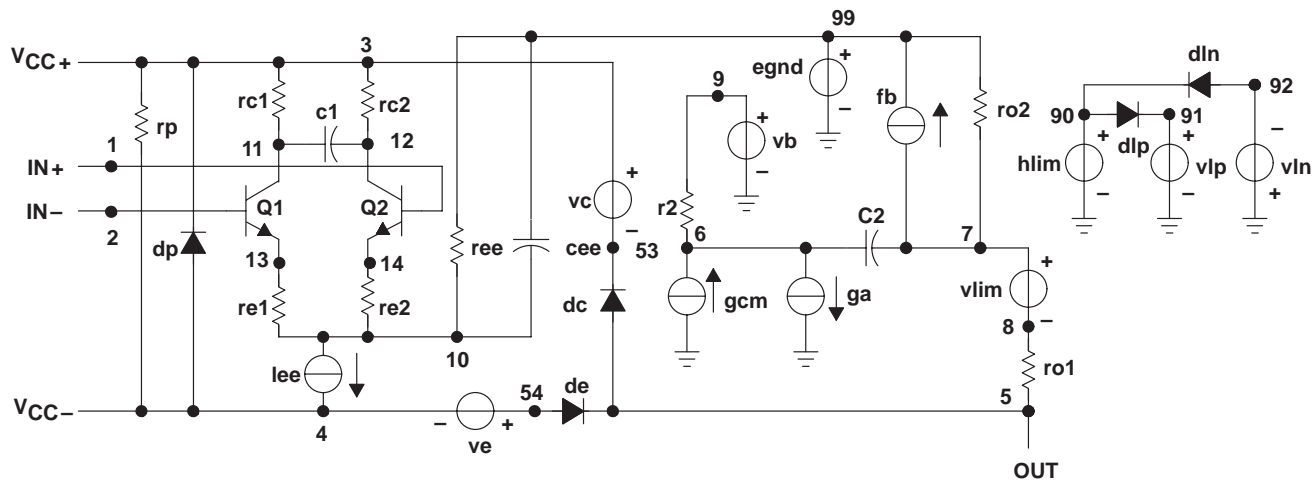

Figure 51. Boyle Macromodel

APPLICATION INFORMATION

TLE2037 macromodel information (continued)

```
.subckt TLE2227 1 2 3 4 5
*
c1 11 12 4.003E-12
c2 6 7 20.00E-12
dc 5 53 dx
de 54 5 dx
dlp 90 91 dx
dln 92 90 dx
dp 4 3 dx
egnd 99 0 poly(2) (3,0) (4,0) 0 .5 .5
fb 7 99 poly(5) vb vc ve vlp vln 0 954.8E6 -1E9 1E9 1E9 -1E9
ga 6 0 11 12 2.062E-3
gcm 0 6 10 99 531.3E-12
iee 10 4 dc 56.01E-6
hlim 90 0 vlim 1K
q1 11 2 13 qx
q2 12 1 14 qx
r2 6 9 100.0E3
rc1 3 11 530.5
rc2 3 12 530.5
re1 13 10 -393.2
re2 14 10 -393.2
ree 10 99 3.571E6
ro1 8 5 25
ro2 7 99 25
rp 3 4 8.013E3
vb 9 0 dc 0
vc 3 53 dc 2.400
ve 54 4 dc 2.100
vlim 7 8 dc 0
vlp 91 0 dc 40
vln 0 92 dc 40
.model dx D(Is=800.0E-18)
.model qx NPN(Is=800.0E-18 Bf=7.000E3)
.ends
```

Figure 52. TLE2237 Macromodel Subcircuit

APPLICATION INFORMATION

voltage-follower applications

The TLE22x7C circuitry includes input-protection diodes to limit the voltage across the input transistors; however, no provision is made in the circuit to limit the current if these diodes are forward biased. This condition can occur when the device is operated in the voltage-follower configuration and driven with a fast, large-signal pulse. A feedback resistor is recommended to limit the current to a maximum of 1 mA to prevent degradation of the device. Also, this feedback resistor forms a pole with the input capacitance of the device. For feedback resistor values greater than 10 k Ω , this pole degrades the amplifier's phase margin. This problem can be alleviated by adding a capacitor (20 pF to 50 pF) in parallel with the feedback resistor (see Figure 53).

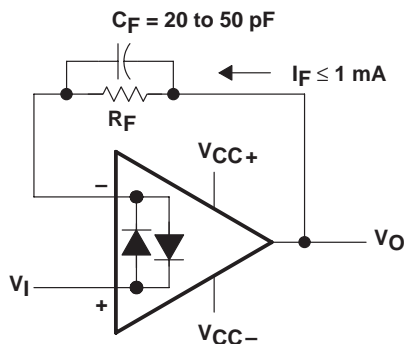

Figure 53. Voltage-Follower Circuit

PACKAGING INFORMATION

Orderable Device	Status ⁽¹⁾	Package Type	Package Drawing	Pins	Package Qty	Eco Plan ⁽²⁾	Lead/Ball Finish	MSL Peak Temp ⁽³⁾
TLE2227CDW	OBSOLETE	SOIC	DW	16		TBD	Call TI	Call TI
TLE2227CP	OBSOLETE	PDIP	P	8		TBD	Call TI	Call TI
TLE2237CDW	OBSOLETE	SOIC	DW	16		TBD	Call TI	Call TI
TLE2237CP	OBSOLETE	PDIP	P	8		TBD	Call TI	Call TI
TLE2237IDW	OBSOLETE	SOIC	DW	16		TBD	Call TI	Call TI

⁽¹⁾ The marketing status values are defined as follows:

ACTIVE: Product device recommended for new designs.

LIFEBUY: TI has announced that the device will be discontinued, and a lifetime-buy period is in effect.

NRND: Not recommended for new designs. Device is in production to support existing customers, but TI does not recommend using this part in a new design.

PREVIEW: Device has been announced but is not in production. Samples may or may not be available.

OBSOLETE: TI has discontinued the production of the device.

⁽²⁾ Eco Plan - The planned eco-friendly classification: Pb-Free (RoHS) or Green (RoHS & no Sb/Br) - please check <http://www.ti.com/productcontent> for the latest availability information and additional product content details.

TBD: The Pb-Free/Green conversion plan has not been defined.

Pb-Free (RoHS): TI's terms "Lead-Free" or "Pb-Free" mean semiconductor products that are compatible with the current RoHS requirements for all 6 substances, including the requirement that lead not exceed 0.1% by weight in homogeneous materials. Where designed to be soldered at high temperatures, TI Pb-Free products are suitable for use in specified lead-free processes.

Green (RoHS & no Sb/Br): TI defines "Green" to mean Pb-Free (RoHS compatible), and free of Bromine (Br) and Antimony (Sb) based flame retardants (Br or Sb do not exceed 0.1% by weight in homogeneous material)

⁽³⁾ MSL, Peak Temp. -- The Moisture Sensitivity Level rating according to the JEDEC industry standard classifications, and peak solder temperature.

Important Information and Disclaimer:The information provided on this page represents TI's knowledge and belief as of the date that it is provided. TI bases its knowledge and belief on information provided by third parties, and makes no representation or warranty as to the accuracy of such information. Efforts are underway to better integrate information from third parties. TI has taken and continues to take reasonable steps to provide representative and accurate information but may not have conducted destructive testing or chemical analysis on incoming materials and chemicals. TI and TI suppliers consider certain information to be proprietary, and thus CAS numbers and other limited information may not be available for release.

In no event shall TI's liability arising out of such information exceed the total purchase price of the TI part(s) at issue in this document sold by TI to Customer on an annual basis.

IMPORTANT NOTICE

Texas Instruments Incorporated and its subsidiaries (TI) reserve the right to make corrections, modifications, enhancements, improvements, and other changes to its products and services at any time and to discontinue any product or service without notice. Customers should obtain the latest relevant information before placing orders and should verify that such information is current and complete. All products are sold subject to TI's terms and conditions of sale supplied at the time of order acknowledgment.

TI warrants performance of its hardware products to the specifications applicable at the time of sale in accordance with TI's standard warranty. Testing and other quality control techniques are used to the extent TI deems necessary to support this warranty. Except where mandated by government requirements, testing of all parameters of each product is not necessarily performed.

TI assumes no liability for applications assistance or customer product design. Customers are responsible for their products and applications using TI components. To minimize the risks associated with customer products and applications, customers should provide adequate design and operating safeguards.

TI does not warrant or represent that any license, either express or implied, is granted under any TI patent right, copyright, mask work right, or other TI intellectual property right relating to any combination, machine, or process in which TI products or services are used. Information published by TI regarding third-party products or services does not constitute a license from TI to use such products or services or a warranty or endorsement thereof. Use of such information may require a license from a third party under the patents or other intellectual property of the third party, or a license from TI under the patents or other intellectual property of TI.

Reproduction of information in TI data books or data sheets is permissible only if reproduction is without alteration and is accompanied by all associated warranties, conditions, limitations, and notices. Reproduction of this information with alteration is an unfair and deceptive business practice. TI is not responsible or liable for such altered documentation.

Resale of TI products or services with statements different from or beyond the parameters stated by TI for that product or service voids all express and any implied warranties for the associated TI product or service and is an unfair and deceptive business practice. TI is not responsible or liable for any such statements.

Following are URLs where you can obtain information on other Texas Instruments products and application solutions:

Products		Applications	
Amplifiers	amplifier.ti.com	Audio	www.ti.com/audio
Data Converters	dataconverter.ti.com	Automotive	www.ti.com/automotive
DSP	dsp.ti.com	Broadband	www.ti.com/broadband
Interface	interface.ti.com	Digital Control	www.ti.com/digitalcontrol
Logic	logic.ti.com	Military	www.ti.com/military
Power Mgmt	power.ti.com	Optical Networking	www.ti.com/opticalnetwork
Microcontrollers	microcontroller.ti.com	Security	www.ti.com/security
		Telephony	www.ti.com/telephony
		Video & Imaging	www.ti.com/video
		Wireless	www.ti.com/wireless

Mailing Address: Texas Instruments
Post Office Box 655303 Dallas, Texas 75265