

Dual Common Base-Collector Bias Resistor Transistors

NPN and PNP Silicon Surface Mount Transistors with Monolithic Bias Resistor Network

UMC2NT1G, NSVUMC2NT1G, UMC3NT1G, NSVUMC3NT1G, UMC5NT1G/T2G, NSVUMC5NT1G/T2G

The Bias Resistor Transistor (BRT) contains a single transistor with a monolithic bias network consisting of two resistors; a series base resistor and a base-emitter resistor. These digital transistors are designed to replace a single device and its external resistor bias network. The BRT eliminates these individual components by integrating them into a single device. In the UMC2NT1G series, two complementary BRT devices are housed in the SOT-353 package which is ideal for low power surface mount applications where board space is at a premium.

Features

- Simplifies Circuit Design
- Reduces Board Space
- Reduces Component Count
- Available in 8 mm, 7 inch/3000 Unit Tape and Reel
- NSV Prefix for Automotive and Other Applications Requiring Unique Site and Control Change Requirements; AEC-Q101 Qualified and PPAP Capable
- These Devices are Pb-Free, Halogen Free/BFR Free and are RoHS Compliant*

MAXIMUM RATINGS ($T_A = 25^\circ\text{C}$ unless otherwise noted, common for Q_1 and Q_2 , - minus sign for Q_1 (PNP) omitted)

Rating	Symbol	Value	Unit
Collector-Base Voltage	V_{CBO}	50	Vdc
Collector-Emitter Voltage	V_{CEO}	50	Vdc
Collector Current	I_C	100	mAdc

Stresses exceeding those listed in the Maximum Ratings table may damage the device. If any of these limits are exceeded, device functionality should not be assumed, damage may occur and reliability may be affected.

*For additional information on our Pb-Free strategy and soldering details, please download the **onsemi** Soldering and Mounting Techniques Reference Manual, SOLDERRM/D.

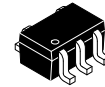

SC-88A/SOT-353
CASE 419A
STYLE 6

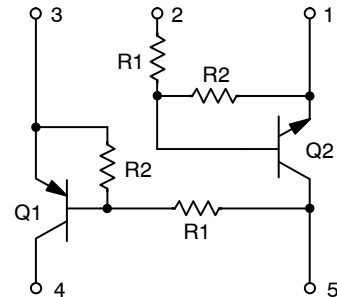

MARKING DIAGRAM

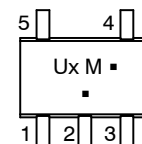

- Ux = Device Marking
- x = 2, 3 or 5
- M = Date Code
- = Pb-Free Package

(Note: Microdot may be in either location)

ORDERING INFORMATION

See detailed ordering and shipping information in the package dimensions section on page 4 of this data sheet.

UMC2NT1G, NSVUMC2NT1G, UMC3NT1G, NSVUMC3NT1G, UMC5NT1G/T2G, NSVUMC5NT1G/T2G

MAXIMUM RATINGS ($T_A = 25^\circ\text{C}$ unless otherwise noted, common for Q_1 and Q_2 , – minus sign for Q_1 (PNP) omitted)

Rating	Symbol	Value	Unit
THERMAL CHARACTERISTICS			
Thermal Resistance – Junction-to-Ambient (surface mounted)	$R_{\theta JA}$	833	$^\circ\text{C/W}$
Operating and Storage Temperature Range	T_J, T_{stg}	-65 to +150	$^\circ\text{C}$
Total Package Dissipation @ $T_A = 25^\circ\text{C}$ (Note 1)	P_D	150	mW

1. Device mounted on a FR-4 glass epoxy printed circuit board using the minimum recommended footprint.

ELECTRICAL CHARACTERISTICS ($T_A = 25^\circ\text{C}$ unless otherwise noted)

Characteristic	Symbol	Min	Typ	Max	Unit
----------------	--------	-----	-----	-----	------

Q1 TRANSISTOR: PNP

OFF CHARACTERISTICS

Collector-Base Cutoff Current ($V_{CB} = 50\text{ V}, I_E = 0$)	I_{CBO}	–	–	100	nAdc
Collector-Emitter Cutoff Current ($V_{CE} = 50\text{ V}, I_B = 0$)	I_{CEO}	–	–	500	nAdc
Emitter-Base Cutoff Current ($V_{EB} = 6.0, I_C = 0\text{ mA}$) UMC2NT1G, NSVUMC2NT1G UMC3NT1G, NSVUMC3NT1G UMC5NT1G/T2G, NSVUMC5NT1G/T2G	I_{EBO}	–	–	0.2 0.5 1.0	mAdc

ON CHARACTERISTICS

Collector-Base Breakdown Voltage ($I_C = 10\ \mu\text{A}, I_E = 0$)	$V_{(BR)CBO}$	50	–	–	Vdc
Collector-Emitter Breakdown Voltage ($I_C = 2.0\text{ mA}, I_B = 0$)	$V_{(BR)CEO}$	50	–	–	Vdc
DC Current Gain ($V_{CE} = 10\text{ V}, I_C = 5.0\text{ mA}$) UMC2NT1G, NSVUMC2NT1G UMC3NT1G, NSVUMC3NT1G UMC5NT1G/T2G, NSVUMC5NT1G/T2G	h_{FE}	60 35 20	100 60 35	– – –	
Collector-Emitter Saturation Voltage ($I_C = 10\text{ mA}, I_B = 0.3\text{ mA}$)	$V_{CE(SAT)}$	–	–	0.25	Vdc
Output Voltage (on) ($V_{CC} = 5.0\text{ V}, V_B = 2.5\text{ V}, R_L = 1.0\text{ k}\Omega$)	V_{OL}	–	–	0.2	Vdc
Output Voltage (off) ($V_{CC} = 5.0\text{ V}, V_B = 0.5\text{ V}, R_L = 1.0\text{ k}\Omega$)	V_{OH}	4.9	–	–	Vdc
Input Resistor UMC2NT1G UMC3NT1G UMC5NT1G/T2G	R1	15.4 7.0 3.3	22 10 4.7	28.6 13 6.1	k Ω
Resistor Ratio UMC2NT1G UMC3NT1G UMC5NT1G/T2G	R1/R2	0.8 0.8 0.38	1.0 1.0 0.47	1.2 1.2 0.56	

UMC2NT1G, NSVUMC2NT1G, UMC3NT1G, NSVUMC3NT1G, UMC5NT1G/T2G, NSVUMC5NT1G/T2G

ELECTRICAL CHARACTERISTICS ($T_A = 25^\circ\text{C}$ unless otherwise noted)

Characteristic	Symbol	Min	Typ	Max	Unit
----------------	--------	-----	-----	-----	------

Q2 TRANSISTOR: NPN OFF CHARACTERISTICS

Collector-Base Cutoff Current ($V_{CB} = 50\text{ V}$, $I_E = 0$)	I_{CBO}	–	–	100	nAdc
Collector-Emitter Cutoff Current ($V_{CE} = 50\text{ V}$, $I_B = 0$)	I_{CEO}	–	–	500	nAdc
Emitter-Base Cutoff Current ($V_{EB} = 6.0$, $I_C = 0\text{ mA}$)	I_{EBO}				mAdc
UMC2NT1G		–	–	0.2	
UMC3NT1G		–	–	0.5	
UMC5NT1G/T2G		–	–	0.1	

ON CHARACTERISTICS

Collector-Base Breakdown Voltage ($I_C = 10\text{ }\mu\text{A}$, $I_E = 0$)	$V_{(BR)CBO}$	50	–	–	Vdc
Collector-Emitter Breakdown Voltage ($I_C = 2.0\text{ mA}$, $I_B = 0$)	$V_{(BR)CEO}$	50	–	–	Vdc
DC Current Gain ($V_{CE} = 10\text{ V}$, $I_C = 5.0\text{ mA}$)	h_{FE}				
UMC2NT1G		60	100	–	
UMC3NT1G		35	60	–	
UMC5NT1G/T2G		80	140	–	
Collector-Emitter Saturation Voltage ($I_C = 10\text{ mA}$, $I_B = 0.3\text{ mA}$)	$V_{CE(SAT)}$	–	–	0.25	Vdc
Output Voltage (on) ($V_{CC} = 5.0\text{ V}$, $V_B = 3.5\text{ V}$, $R_L = 1.0\text{ k}\Omega$)	V_{OL}	–	–	0.2	Vdc
Output Voltage (off) ($V_{CC} = 5.0\text{ V}$, $V_B = 0.5\text{ V}$, $R_L = 1.0\text{ k}\Omega$)	V_{OH}	4.9	–	–	Vdc
Input Resistor	R1				k Ω
UMC2NT1G		15.4	22	28.6	
UMC3NT1G		7.0	10	13	
UMC5NT1G/T2G		33	47	61	
Resistor Ratio	R1/R2				
UMC2NT1G		0.8	1.0	1.2	
UMC3NT1G		0.8	1.0	1.2	
UMC5NT1G/T2G		0.8	1.0	1.2	

UMC2NT1G, NSVUMC2NT1G, UMC3NT1G, NSVUMC3NT1G, UMC5NT1G/T2G, NSVUMC5NT1G/T2G

ORDERING INFORMATION

Device	Package	Shipping [†]
UMC2NT1G, NSVUMC2NT1G*	SC-88A/SOT-353 (Pb-Free)	3,000 / Tape & Reel
UMC3NT1G, NSVUMC3NT1G*	SC-88A/SOT-353 (Pb-Free)	3,000 / Tape & Reel
UMC3NT2G	SC-88A/SOT-353 (Pb-Free)	3,000 / Tape & Reel
UMC5NT1G, NSVUMC5NT1G*	SC-88A/SOT-353 (Pb-Free)	3,000 / Tape & Reel
UMC5NT2G, NSVUMC5NT2G*	SC-88A/SOT-353 (Pb-Free)	3,000 / Tape & Reel

†For information on tape and reel specifications, including part orientation and tape sizes, please refer to our Tape and Reel Packaging Specifications Brochure, BRD8011/D.

*NSV Prefix for Automotive and Other Applications Requiring Unique Site and Control Change Requirements; AEC-Q101 Qualified and PPAP Capable.

DEVICE MARKING AND RESISTOR VALUES

Device	Marking	Transistor 1 - PNP		Transistor 2 - NPN	
		R1 (K)	R2 (K)	R1 (K)	R2 (K)
UMC2NT1G, NSVUMC2NT1G	U2	22	22	22	22
UMC3NT1G, NSVUMC3NT1G	U3	10	10	10	10
UMC3NT2G	U3	10	10	10	10
UMC5NT1G, NSVUMC5NT1G	U5	4.7	10	47	47
UMC5NT2G, NSVUMC5NT2G	U5	4.7	10	47	47

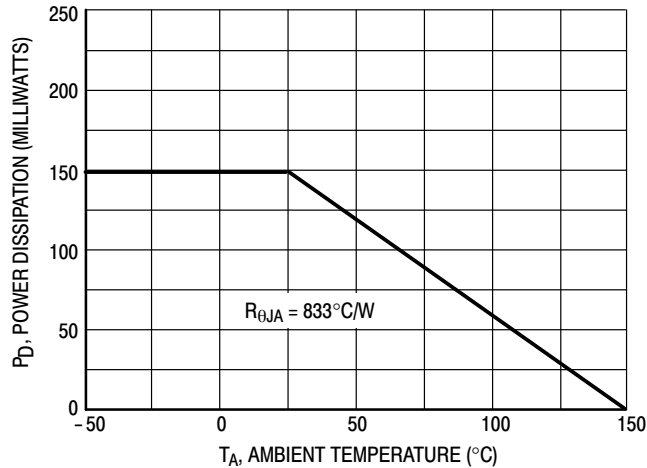

Figure 1. Derating Curve

**UMC2NT1G, NSVUMC2NT1G, UMC3NT1G, NSVUMC3NT1G, UMC5NT1G/T2G,
NSVUMC5NT1G/T2G**

TYPICAL ELECTRICAL CHARACTERISTICS — UMC2NT1G, NSVUMC2NT1G PNP TRANSISTOR

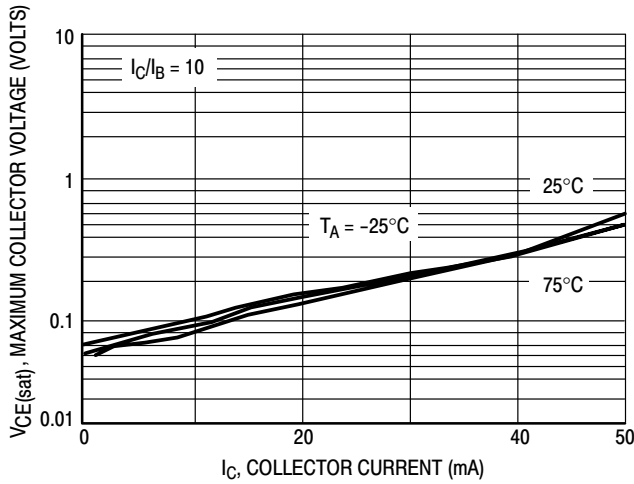

Figure 2. $V_{CE(sat)}$ versus I_C

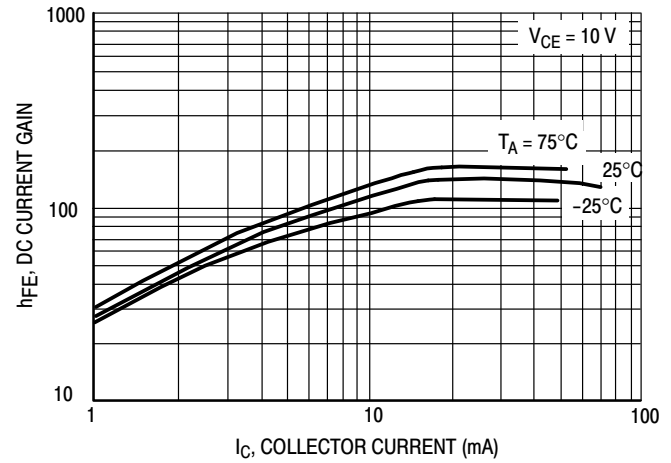

Figure 3. DC Current Gain

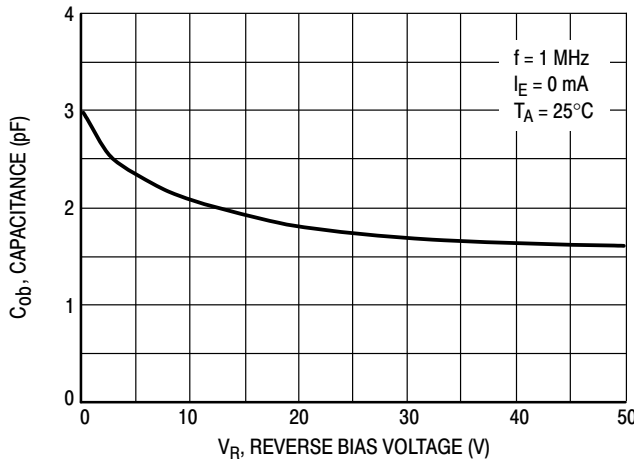

Figure 4. Output Capacitance

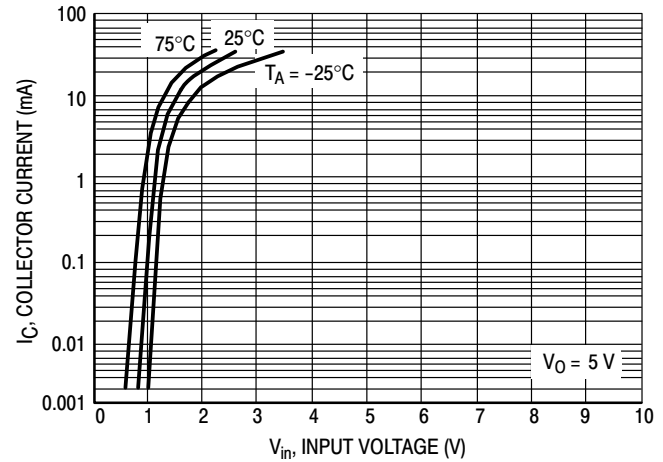

Figure 5. Output Current versus Input Voltage

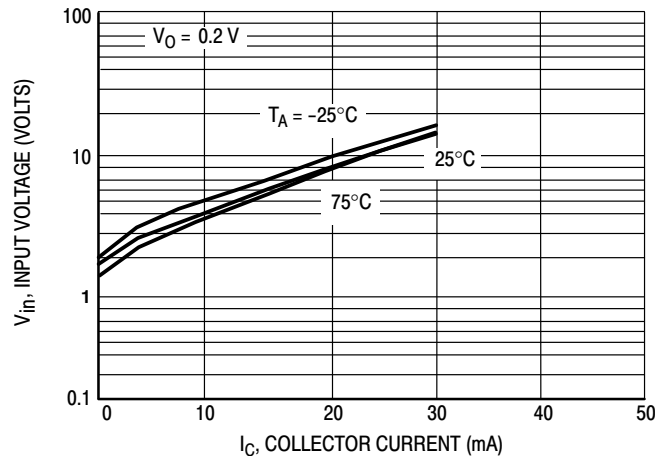

Figure 6. Input Voltage versus Output Current

**UMC2NT1G, NSVUMC2NT1G, UMC3NT1G, NSVUMC3NT1G, UMC5NT1G/T2G,
NSVUMC5NT1G/T2G**

TYPICAL ELECTRICAL CHARACTERISTICS — UMC2NT1G, NSVUMC2NT1G NPN TRANSISTOR

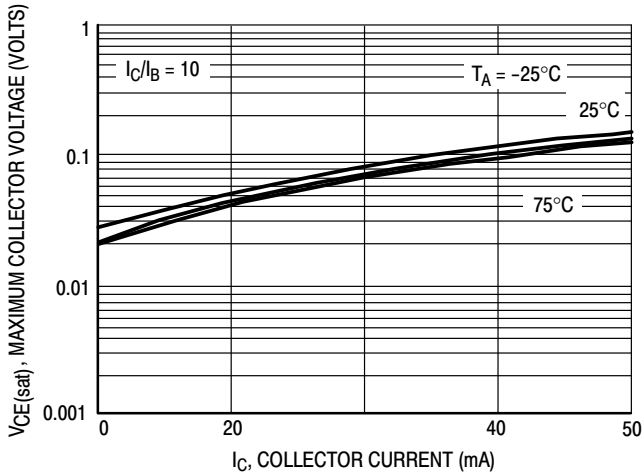

Figure 7. $V_{CE(sat)}$ versus I_C

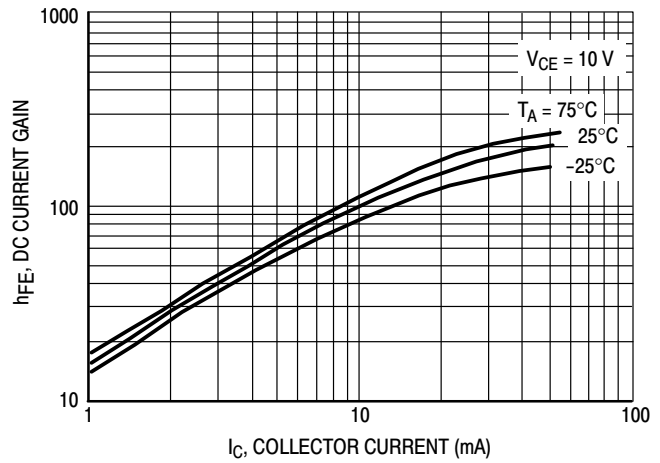

Figure 8. DC Current Gain

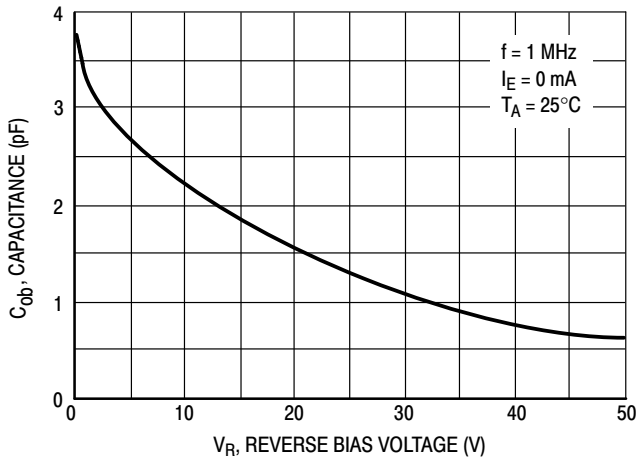

Figure 9. Output Capacitance

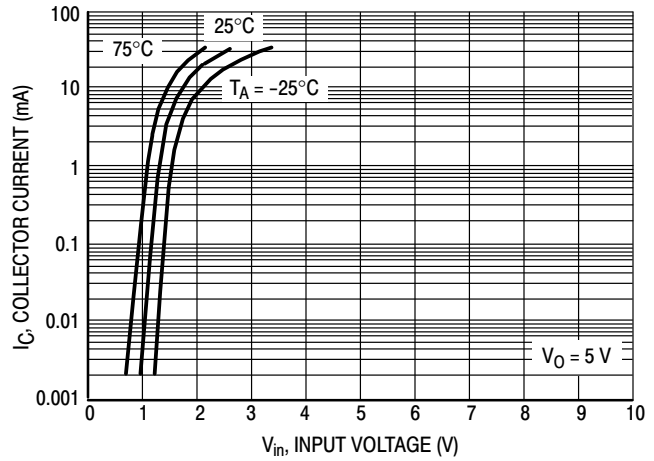

Figure 10. Output Current versus Input Voltage

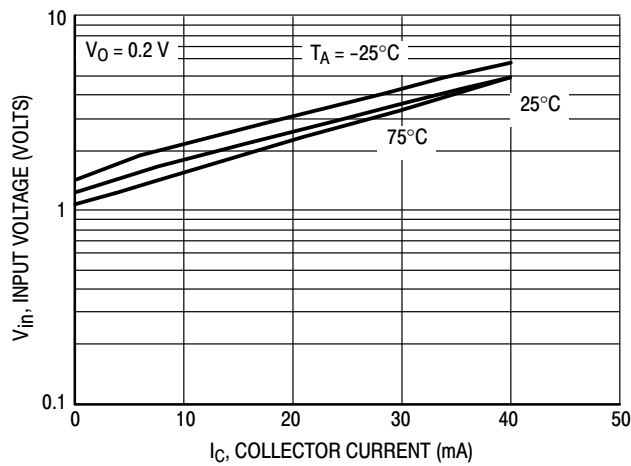

Figure 11. Input Voltage versus Output Current

UMC2NT1G, NSVUMC2NT1G, UMC3NT1G, NSVUMC3NT1G, UMC5NT1G/T2G, NSVUMC5NT1G/T2G

TYPICAL ELECTRICAL CHARACTERISTICS — UMC3NT1G PNP TRANSISTOR

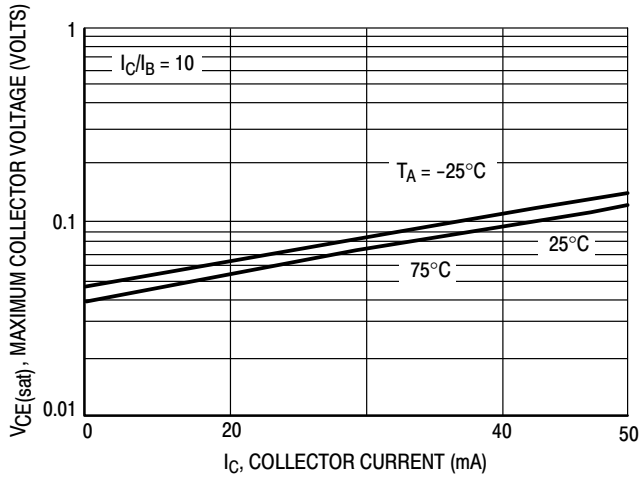

Figure 12. $V_{CE(sat)}$ versus I_C

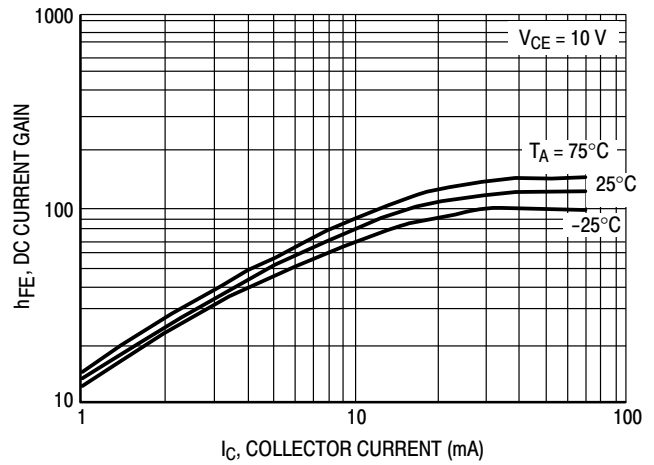

Figure 13. DC Current Gain

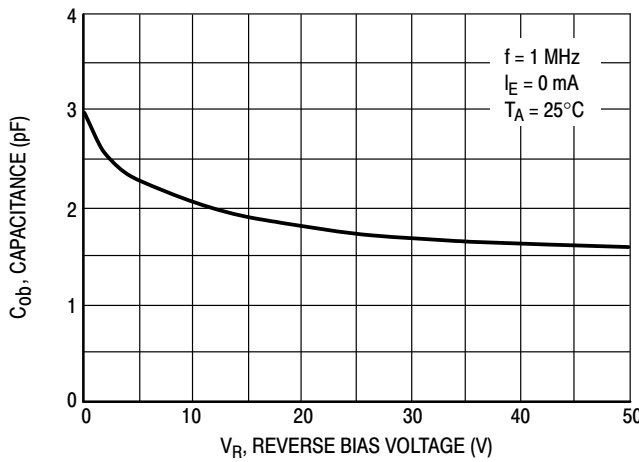

Figure 14. Output Capacitance

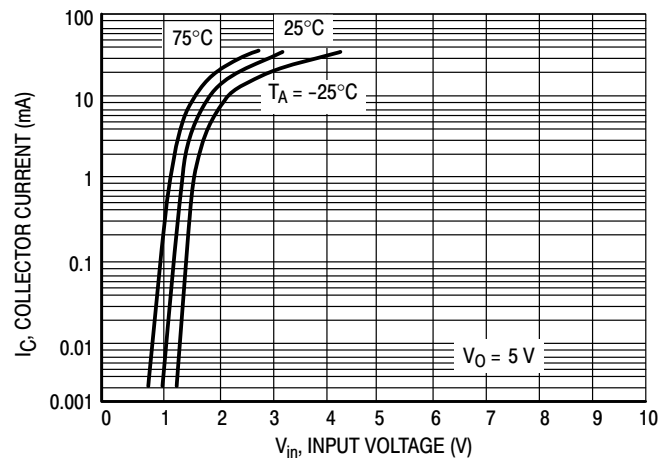

Figure 15. Output Current versus Input Voltage

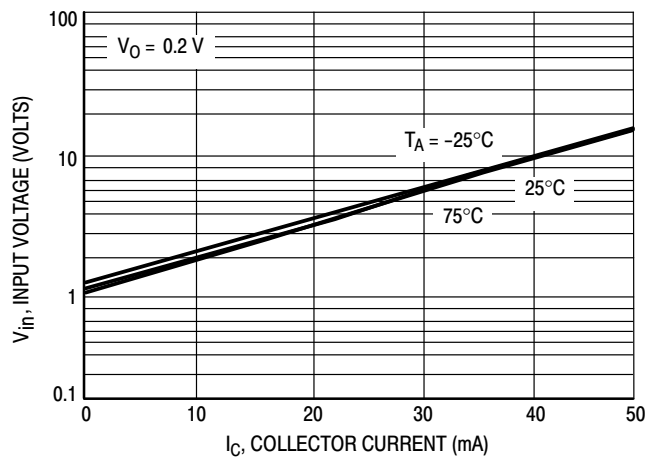

Figure 16. Input Voltage versus Output Current

UMC2NT1G, NSVUMC2NT1G, UMC3NT1G, NSVUMC3NT1G, UMC5NT1G/T2G,
NSVUMC5NT1G/T2G

TYPICAL ELECTRICAL CHARACTERISTICS — UMC3NT1G NPN TRANSISTOR

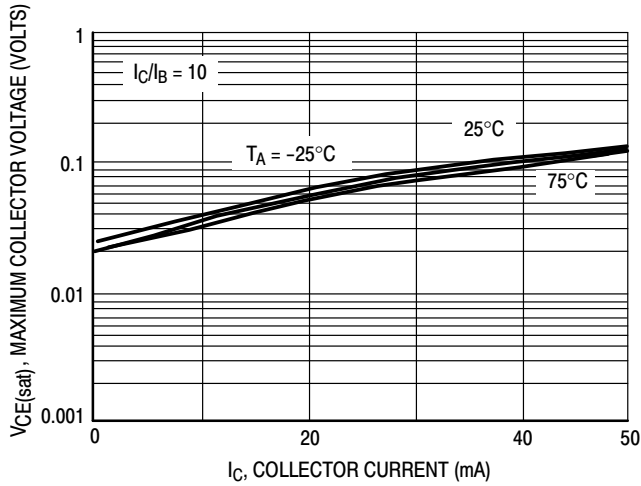

Figure 17. $V_{CE(sat)}$ versus I_C

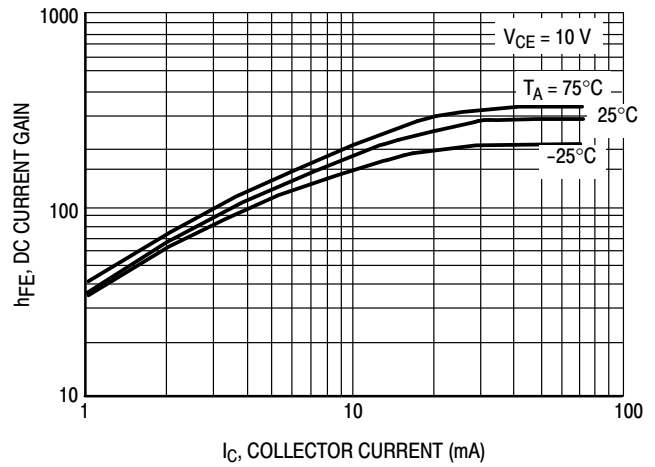

Figure 18. DC Current Gain

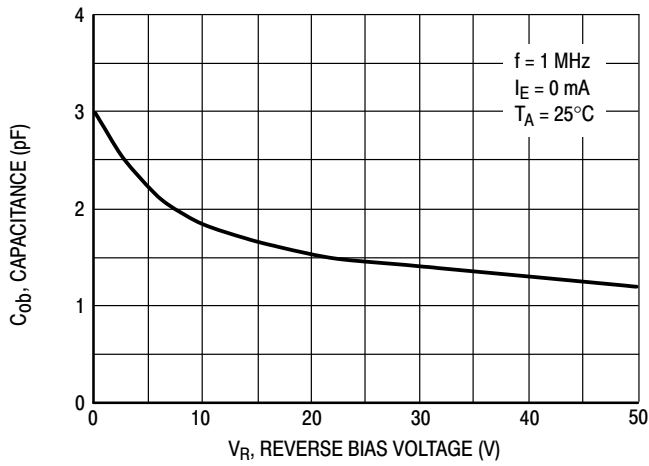

Figure 19. Output Capacitance

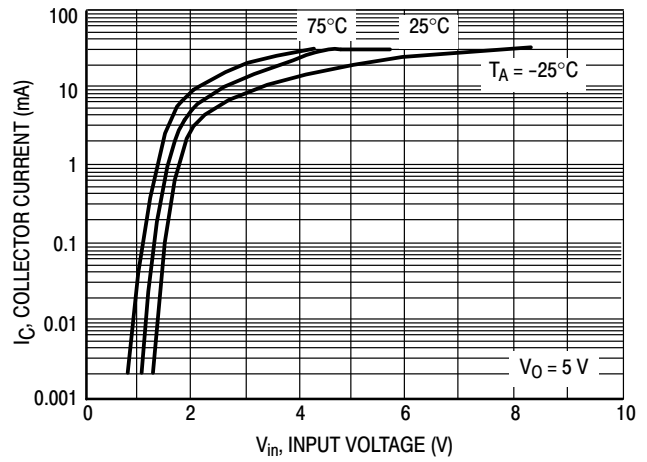

Figure 20. Output Current versus Input Voltage

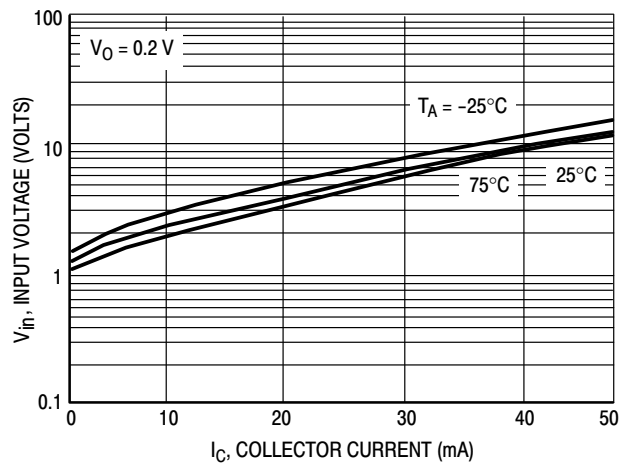

Figure 21. Input Voltage versus Output Current

UMC2NT1G, NSVUMC2NT1G, UMC3NT1G, NSVUMC3NT1G, UMC5NT1G/T2G,
NSVUMC5NT1G/T2G

TYPICAL ELECTRICAL CHARACTERISTICS — UMC5NT1G PNP TRANSISTOR

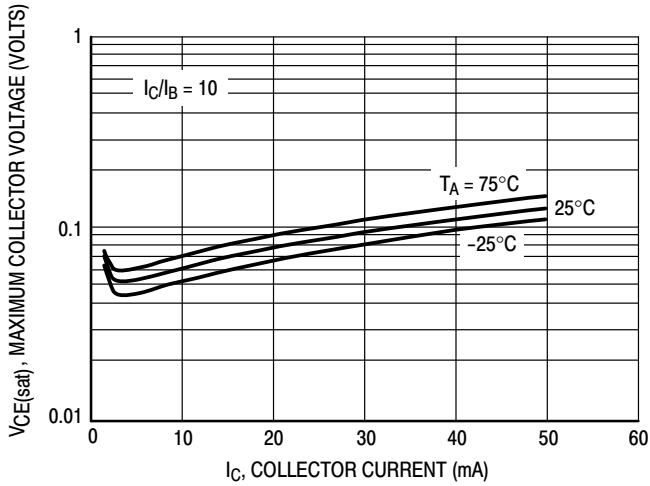

Figure 22. $V_{CE(sat)}$ versus I_C

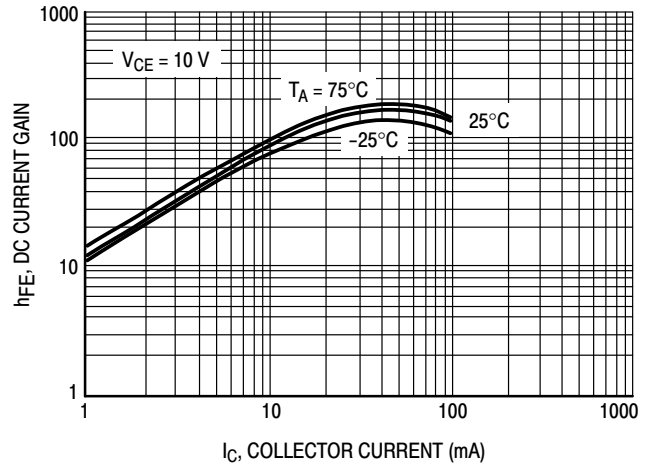

Figure 23. DC Current Gain

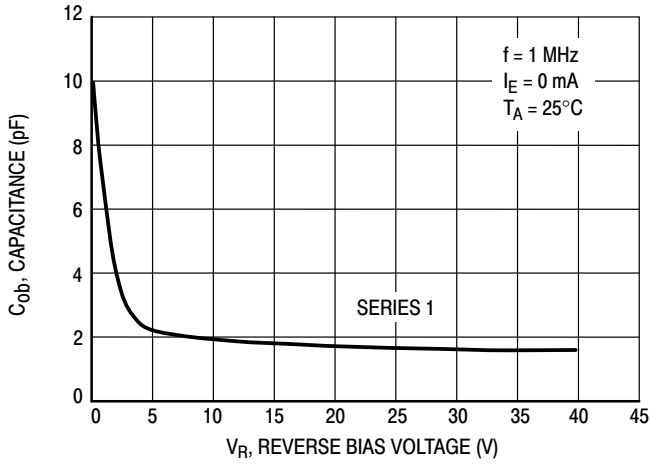

Figure 24. Output Capacitance

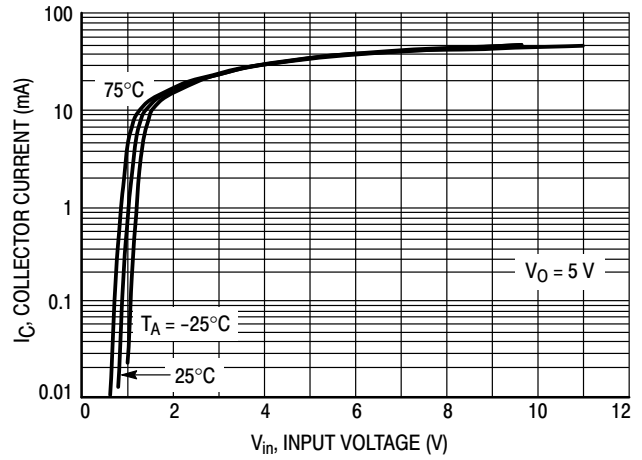

Figure 25. Output Current versus Input Voltage

UMC2NT1G, NSVUMC2NT1G, UMC3NT1G, NSVUMC3NT1G, UMC5NT1G/T2G, NSVUMC5NT1G/T2G

TYPICAL ELECTRICAL CHARACTERISTICS — UMC5NT1G NPN TRANSISTOR

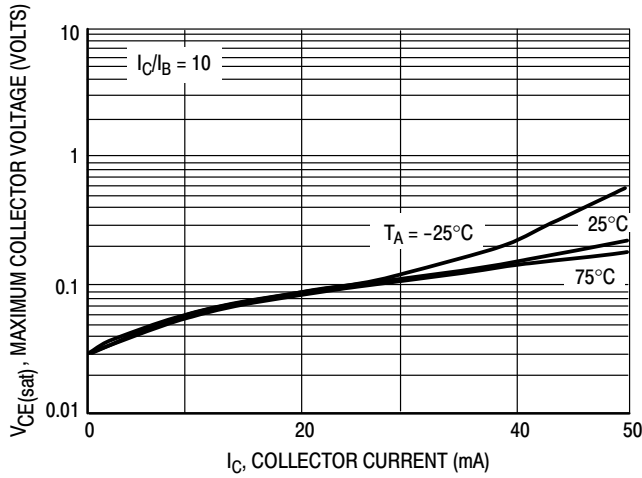

Figure 26. $V_{CE(sat)}$ versus I_C

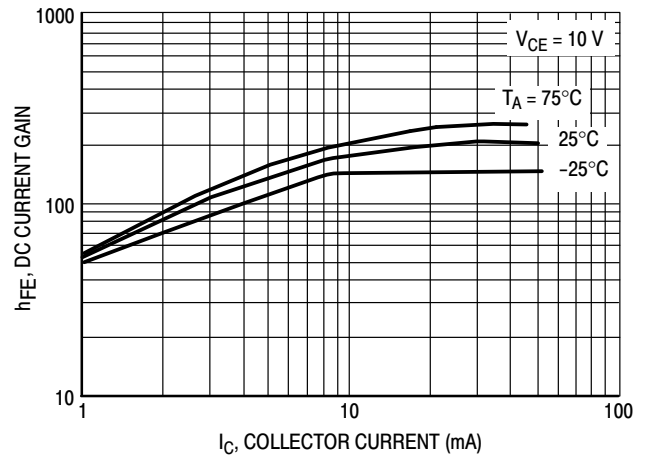

Figure 27. DC Current Gain

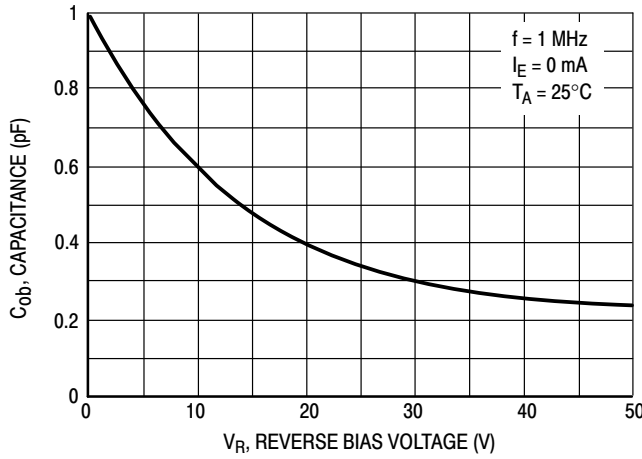

Figure 28. Output Capacitance

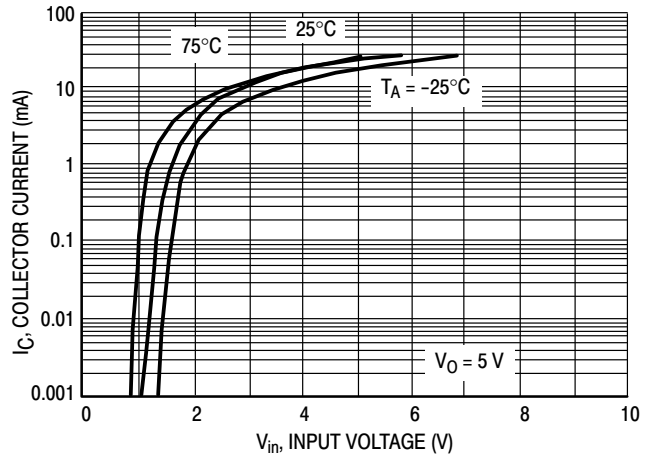

Figure 29. Output Current versus Input Voltage

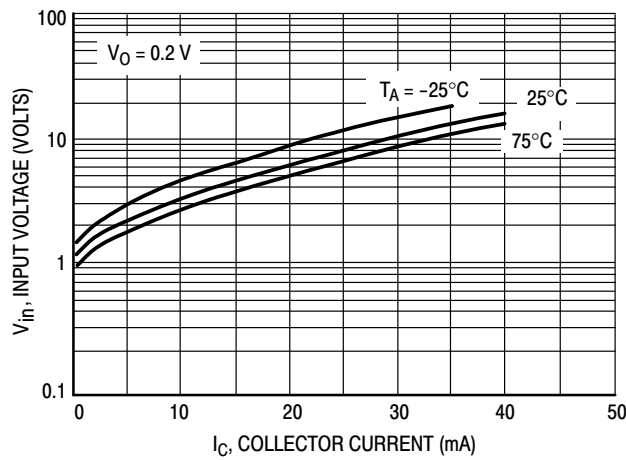

Figure 30. Input Voltage versus Output Current

MECHANICAL CASE OUTLINE PACKAGE DIMENSIONS



SCALE 2:1

SC-88A (SC-70-5/SOT-353) CASE 419A-02 ISSUE M

DATE 11 APR 2023

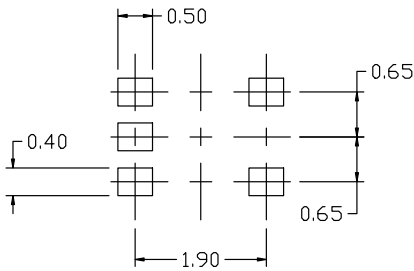
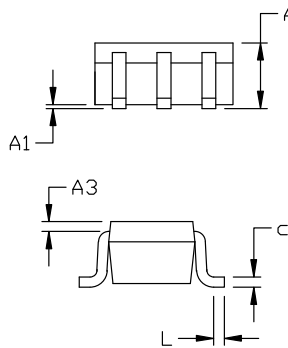
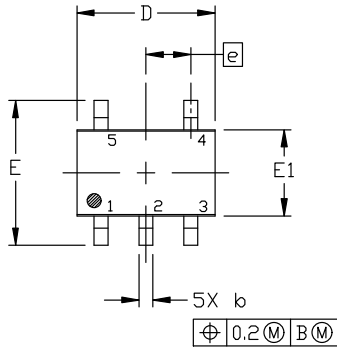

RECOMMENDED
MOUNTING FOOTPRINT

* For additional information on our Pb-Free strategy and soldering details, please download the ON Semiconductor Soldering and Mounting Techniques Reference Manual, SOLDERM/D.

NOTES:

1. DIMENSIONING AND TOLERANCING PER ANSI Y14.5M, 1982.
2. CONTROLLING DIMENSION: MILLIMETERS
3. 419A-01 OBSOLETE. NEW STANDARD 419A-02
4. DIMENSIONS D AND E1 DO NOT INCLUDE MOLD FLASH, PROTRUSIONS, OR GATE BURRS. MOLD FLASH, PROTRUSIONS, OR GATE BURRS SHALL NOT EXCEED 0.1016MM PER SIDE.

DIM	MILLIMETERS		
	MIN.	NOM.	MAX.
A	0.80	0.95	1.10
A1	---	---	0.10
A3	0.20 REF		
b	0.10	0.20	0.30
c	0.10	---	0.25
D	1.80	2.00	2.20
E	2.00	2.10	2.20
E1	1.15	1.25	1.35
e	0.65 BSC		
L	0.10	0.15	0.30

GENERIC MARKING DIAGRAM*

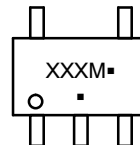

*This information is generic. Please refer to device data sheet for actual part marking. Pb-Free indicator, "G" or microdot "▪", may or may not be present. Some products may not follow the Generic Marking.

XXX = Specific Device Code

M = Date Code

▪ = Pb-Free Package

(Note: Microdot may be in either location)

STYLE 1:

1. BASE
2. EMITTER
3. BASE
4. COLLECTOR
5. COLLECTOR

STYLE 2:

1. ANODE
2. EMITTER
3. BASE
4. COLLECTOR
5. CATHODE

STYLE 3:

1. ANODE 1
2. N/C
3. ANODE 2
4. CATHODE 2
5. CATHODE 1

STYLE 4:

1. SOURCE 1
2. DRAIN 1/2
3. SOURCE 1
4. GATE 1
5. GATE 2

STYLE 5:

1. CATHODE
2. COMMON ANODE
3. CATHODE 2
4. CATHODE 3
5. CATHODE 4

STYLE 6:

1. EMITTER 2
2. BASE 2
3. EMITTER 1
4. COLLECTOR
5. COLLECTOR 2/BASE 1

STYLE 7:

1. BASE
2. EMITTER
3. BASE
4. COLLECTOR
5. COLLECTOR

STYLE 8:

1. CATHODE
2. COLLECTOR
3. N/C
4. BASE
5. EMITTER

STYLE 9:

1. ANODE
2. CATHODE
3. ANODE
4. ANODE
5. ANODE

Note: Please refer to datasheet for style callout. If style type is not called out in the datasheet refer to the device datasheet pinout or pin assignment.

DOCUMENT NUMBER:	98ASB42984B	Electronic versions are uncontrolled except when accessed directly from the Document Repository. Printed versions are uncontrolled except when stamped "CONTROLLED COPY" in red.
DESCRIPTION:	SC-88A (SC-70-5/SOT-353)	PAGE 1 OF 1

onsemi and ONSEMI are trademarks of Semiconductor Components Industries, LLC dba onsemi or its subsidiaries in the United States and/or other countries. onsemi reserves the right to make changes without further notice to any products herein. onsemi makes no warranty, representation or guarantee regarding the suitability of its products for any particular purpose, nor does onsemi assume any liability arising out of the application or use of any product or circuit, and specifically disclaims any and all liability, including without limitation special, consequential or incidental damages. onsemi does not convey any license under its patent rights nor the rights of others.

onsemi, **Onsemi**, and other names, marks, and brands are registered and/or common law trademarks of Semiconductor Components Industries, LLC dba "**onsemi**" or its affiliates and/or subsidiaries in the United States and/or other countries. **onsemi** owns the rights to a number of patents, trademarks, copyrights, trade secrets, and other intellectual property. A listing of **onsemi**'s product/patent coverage may be accessed at www.onsemi.com/site/pdf/Patent-Marking.pdf. **onsemi** reserves the right to make changes at any time to any products or information herein, without notice. The information herein is provided "as-is" and **onsemi** makes no warranty, representation or guarantee regarding the accuracy of the information, product features, availability, functionality, or suitability of its products for any particular purpose, nor does **onsemi** assume any liability arising out of the application or use of any product or circuit, and specifically disclaims any and all liability, including without limitation special, consequential or incidental damages. Buyer is responsible for its products and applications using **onsemi** products, including compliance with all laws, regulations and safety requirements or standards, regardless of any support or applications information provided by **onsemi**. "Typical" parameters which may be provided in **onsemi** data sheets and/or specifications can and do vary in different applications and actual performance may vary over time. All operating parameters, including "Typicals" must be validated for each customer application by customer's technical experts. **onsemi** does not convey any license under any of its intellectual property rights nor the rights of others. **onsemi** products are not designed, intended, or authorized for use as a critical component in life support systems or any FDA Class 3 medical devices or medical devices with a same or similar classification in a foreign jurisdiction or any devices intended for implantation in the human body. Should Buyer purchase or use **onsemi** products for any such unintended or unauthorized application, Buyer shall indemnify and hold **onsemi** and its officers, employees, subsidiaries, affiliates, and distributors harmless against all claims, costs, damages, and expenses, and reasonable attorney fees arising out of, directly or indirectly, any claim of personal injury or death associated with such unintended or unauthorized use, even if such claim alleges that **onsemi** was negligent regarding the design or manufacture of the part. **onsemi** is an Equal Opportunity/Affirmative Action Employer. This literature is subject to all applicable copyright laws and is not for resale in any manner.

PUBLICATION ORDERING INFORMATION

LITERATURE FULFILLMENT:

Email Requests to: orderlit@onsemi.com

onsemi Website: www.onsemi.com

TECHNICAL SUPPORT

North American Technical Support:

Voice Mail: 1 800-282-9855 Toll Free USA/Canada

Phone: 011 421 33 790 2910

Europe, Middle East and Africa Technical Support:

Phone: 00421 33 790 2910

For additional information, please contact your local Sales Representative