

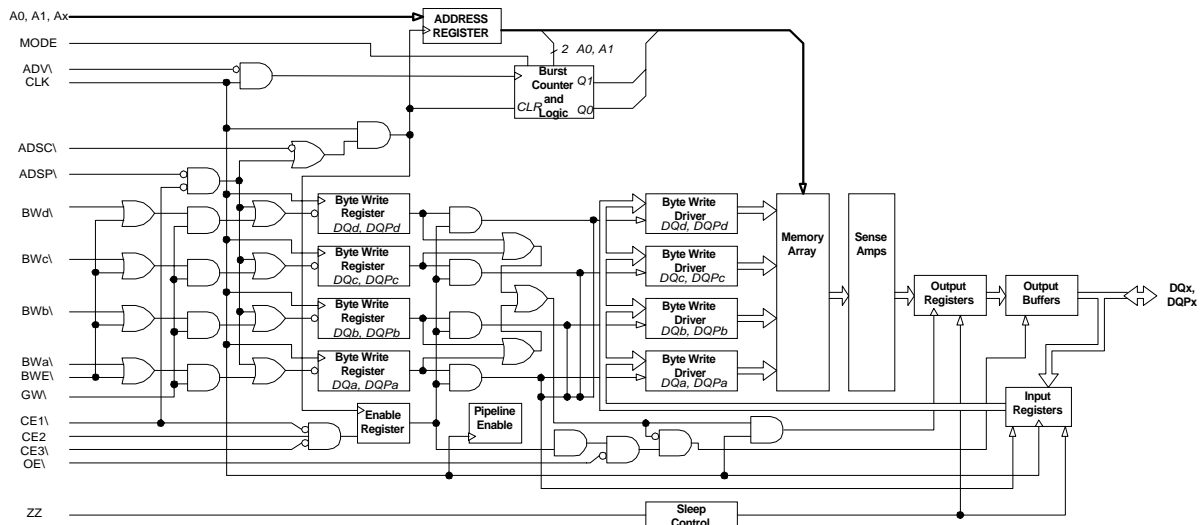

Pin Description/Assignment Table

Signal Name	Symbol	Type	Pin	Description
Clock	CLK	Input	89	This input registers the address, data, enables, Global and Byte writes as well as the burst control functions
Address	A0, A1	Input	37, 36	Low order, Synchronous Address Inputs and Burst counter address inputs
Address	A	Input(s)	35, 34, 33, 32, 31, 100, 99, 82, 81, 44, 45, 46, 47, 48, 49, 50	Synchronous Address Inputs
Chip Enable	CE1\, CE3\	Input	98, 92	Active Low True Chip Enables
Chip Enable	CE2	Input	97	Active High True Chip Enable
Global Write Enable	GW\	Input	88	Active Low True Global Write enable. Write to all bits
Byte Enables	BWa\, BWb\, BWc\, BWd\	Input	93, 94, 95, 96	Active Low True Byte Write enables. Write to byte segments
Byte Write Enable	BWE\	Input	87	Active Low True Byte Write Function enable
Output Enable	OE\	Input	86	Active Low True Asynchronous Output enable
Address Strobe Controller	ADSC\	Input	85	Address Strobe from Controller. When asserted LOW, Address is captured in the address registers and A0-A1 are loaded into the Burst When ADSP\ and ADSC are both asserted, only ADSP is recognized
Address Strobe from Processor	ADSP\	Input	84	Synchronous Address Strobe from Processor. When asserted LOW, Address is captured in the Address registers, A0-A1 is registered in the burst counter. When both ADSP\ and ADSC\ or both asserted, only ADSP\ is recognized. ADSP\ is ignored when CE1\ is HIGH
Address Advance	ADV	Input	83	Advance input Address. When asserted HIGH, address in burst counter is incremented.
Power-Down	ZZ	Input	64	Asynchronous, non-time critical Power-down Input control. Places the chip into an ultra low power mode, with data preserved.
Data Parity Input/Outputs	DQPc, DQPd DQPa, DQPb	Input/ Output	51, 80, 1, 30	Bidirectional I/O Parity lines. As inputs they reach the memory array via an input register, the address stored in the register on the rising edge of clock. As and output, the line delivers the valid data stored in the array via an output register and output driver. The data delivered is from the previous clock period of the READ cycle.
Data Input/Outputs	DQc, DQd DQa, DQb	Input/ Output	52, 53, 56, 57, 58, 59, 62, 63, 68, 69, 72, 73, 74, 75, 78, 79, 2, 3, 6, 7, 8, 9, 12, 13, 18, 19, 22, 23, 24, 25, 28, 29	Bidirectional I/O Data lines. As inputs they reach the memory array via an input register, the address stored in the register on the rising edge of clock. As and output, the line delivers the valid data stored in the array via an output register and output driver. The data delivered is from the previous clock period of the READ cycle.
Burst Mode	MODE	Input	31	Interleaved or Linear Burst mode control
Power Supply [Core]	VDD	Supply	91, 15, 41, 65	Core Power Supply
Ground [Core]	VSS	Supply	90, 17, 40, 67	Core Power Supply Ground
Power Supply I/O	VDDQ	Supply	4, 11, 20, 27, 54, 61, 70, 77	Isolated Input/Output Buffer Supply
I/O Ground	VSSQ	Supply	5, 10, 21, 26, 55, 60, 71, 76	Isolated Input/Output Buffer Ground
No Connection(s)	NC	NA	14, 16, 38, 39, 66, 38,39,42,43	No connections to internal silicon

Logic Block Diagram





Functional Description

Austin Semiconductor's AS5SP128K36DQ Synchronous SRAM is manufactured to support today's High Performance platforms utilizing the Industries leading Processor elements including those of Intel and Motorola. The AS5SP128K36DQ supports Synchronous SRAM READ and WRITE operations as well as Synchronous Burst READ/WRITE operations. All inputs with the exception of OE\, MODE and ZZ are synchronous in nature and sampled and registered on the rising edge of the devices input clock (CLK). The type, start and the duration of Burst Mode operations is controlled by MODE, ADSC\, ADSP\ and ADV as well as the Chip Enable pins CE1\, CE2, and CE3\. All synchronous accesses including the Burst accesses are enabled via the use of the multiple enable pins and wait state insertion is supported and controlled via the use of the Advance control (ADV).

The ASI AS5SP128K36DQ supports both Interleaved as well as Linear Burst modes therefore making it an architectural fit for either the Intel or Motorola CISC processor elements available on the Market today.

The AS5SP128K36DQ supports Byte WRITE operations and enters this functional mode with the Byte Write Enable (BWE\), and the Byte Write Select pin(s) (BWA\, BWb\, BWc\, BWD\). Global Writes are supported via the Global Write Enable (GW\), and Global Write Enable will override the Byte Write inputs and will perform a Write to all Data I/Os.

The AS5SP128K36DQ provides ease of producing very dense arrays via the multiple Chip Enable input pins and Tri-state outputs.

Single Cycle Access Operations

A Single READ operation is initiated when all of the following conditions are satisfied at the time of Clock (CLK) HIGH: [1] ADSP\ or ADSC\ is asserted LOW, [2] Chip Enables are all asserted active, and [3] the WRITE signals (GW\, BWE\), are in their FALSE state (HIGH). ADSP\ is ignored if CE1\ is HIGH. The address presented to the Address inputs is stored within the Address Registers and Address Counter/Advancement Logic and then passed or presented to the array core. The corresponding data of the addressed location is propagated to the Output Registers and passed to the data bus on the next rising clock via the Output Buffers. The time at which the data is presented to the Data bus is as specified by either the Clock to Data valid specification or the Output Enable to Data Valid spec for the device speed grade chosen. The only exception occurs when the device is recovering from a deselected to select state where its outputs are tristated in the first machine cycle and controlled by its Output Enable (OE\), on following cycle. Consecutive single

cycle READS are supported. Once the READ operation has been completed and deselected by use of the Chip Enable(s) and either ADSP\ or ADSC\, its outputs will tri-state immediately.

A Single ADSP\ controlled WRITE operation is initiated when both of the following conditions are satisfied at the time of Clock (CLK) HIGH: [1] ADSP\ is asserted LOW, and [2] Chip Enable(s) are asserted ACTIVE. The address presented to the address bus is registered and loaded on CLK HIGH, then presented to the core array. The WRITE controls Global Write, and Byte Write Enable (GW\, BWE\), as well as the individual Byte Writes (BWA\, BWb\, BWc\, and BWD\), and ADV\ are ignored on the first machine cycle. ADSP\ triggered WRITE accesses require two (2) machine cycles to complete. If Global Write is asserted LOW on the second Clock (CLK) rise, the data presented to the array via the Data bus will be written into the array at the corresponding address location specified by the Address bus. If GW\ is HIGH (inactive) then BWE\ and one or more of the Byte Write controls (BWA\, BWb\, BWc\, and BWD\), controls the write operation. All WRITES that are initiated in this device are internally self timed.

A Single ADSC\ controlled WRITE operation is initiated when the following conditions are satisfied: [1] ADSC\ is asserted LOW, [2] ADSP\ is de-asserted (HIGH), [3] Chip Enable(s) are asserted (TRUE or Active), and [4] the appropriate combination of the WRITE inputs (GW\, BWE\, BWx\), are asserted (ACTIVE). Thus completing the WRITE to the desired Byte(s) or the complete data-path. ADSC\ triggered WRITE accesses require a single clock (CLK) machine cycle to complete. The address presented to the input Address bus pins at time of clock HIGH will be the location that the WRITE occurs. The ADV pin is ignored during this cycle, and the data WRITTEN to the array will either be a BYTE WRITE or a GLOBAL WRITE depending on the use of the WRITE control functions GW\ and BWE\, as well as the individual BYTE CONTROLS (BWx\).

Deep Power-Down Mode (SLEEP)

The AS5SP128K36DQ has a Deep Power-Down mode and is controlled by the ZZ pin. The ZZ pin is an Asynchronous input and asserting this pin places the SSRAM in a deep power-down mode (SLEEP). While in this mode, Data integrity is guaranteed. For the device to be placed successfully into this operational mode the device must be deselected and the Chip Enables, ADSP\ and ADSC\ remain inactive for the duration of tZZREC after the ZZ input returns LOW. Use of this deep power-down mode conserves power and is very useful in multiple memory page designs where the mode recovery time can be hidden.



Synchronous Truth Tables

CE1\	CE2	CE3\	ADSP\	ADSC\	ADV	WT / RD	CLK	Address Accessed	Operation
H	X	X	X	L	X	X	▲	NA	Not Selected
L	L	X	L	X	X	X	▲	NA	Not Selected
L	X	H	L	X	X	X	▲	NA	Not Selected
L	L	X	X	L	X	X	▲	NA	Not Selected
L	X	H	X	L	X	X	▲	NA	Not Selected
L	H	L	L	X	X	X	▲	External Address	Begin Burst, READ
L	H	L	H	L	X	WT	▲	External Address	Begin Burst, WRITE
L	H	L	H	L	X	RD	▲	External Address	Begin Burst, READ
X	X	X	H	H	L	RD	▲	Next Address	Continue Burst, READ
H	X	X	X	H	L	RD	▲	Next Address	Continue Burst, READ
X	X	X	H	H	L	WT	▲	Next Address	Continue Burst, WRITE
H	X	X	X	H	L	WT	▲	Next Address	Continue Burst, WRITE
X	X	X	H	H	H	RD	▲	Current Address	Suspend Burst, READ
H	X	X	X	H	H	RD	▲	Current Address	Suspend Burst, READ
X	X	X	H	H	H	WT	▲	Current Address	Suspend Burst, WRITE
H	X	X	X	H	H	WT	▲	Current Address	Suspend Burst, WRITE

Notes:
1. X = Don't Care
2. WT= WRITE operation in WRITE TABLE, RD= READ operation in WRITE TABLE

Burst Sequence Tables

Burst Control Pin [MODE]	State	Interleaved Burst							
		Case 1		Case 2		Case 3		Case 4	
	HIGH	A1	A0	A1	A0	A1	A0	A1	A0
First Address		0	0	0	1	1	0	1	1
↓		0	1	0	0	1	1	1	0
Fourth Address		1	0	1	1	0	0	0	1
		1	1	1	0	0	1	0	0

Burst Control Pin [MODE]	State	Linear Burst							
		Case 1		Case 2		Case 3		Case 4	
	LOW	A1	A0	A1	A0	A1	A0	A1	A0
First Address		0	0	0	1	1	0	1	1
↓		0	1	1	0	1	1	0	0
Fourth Address		1	0	1	1	0	0	0	1
		1	1	0	0	0	1	1	0

Capacitance

Parameter	Symbol	Max.	Units
Input Capacitance	CI	5.0	pF
Input/Output Capacitance	CIO	5.0	pF
Clock Input Capacitance	CCLK	5.0	pF

Write Table

GW\	BW\	BWa\	BWb\	BWc\	BWd\	Operation
H	H	X	X	X	X	READ
H	L	H	H	H	H	READ
H	L	L	H	H	H	WRITE Byte [A]
H	L	H	L	H	H	WRITE Byte [B]
H	L	H	H	L	L	WRITE Byte [C], [D]
H	L	L	L	L	L	WRITE ALL Bytes
L	X	X	X	X	X	WRITE ALL Bytes

Asynchronous Truth Table

Operation	ZZ	OE\	I/O Status
Power-Down (SLEEP)	H	X	High-Z
READ	L	L	DQ
WRITE	L	H	High-Z
WRITE	L	X	Din, High-Z
De-Selected	L	X	High-Z

Absolute Maximum Ratings*

Parameter	Symbol	Min.	Max.	Units
Voltage on VDD Pin	VDD	-0.3	4.6	V
Voltage on VDDQ Pins	VDDQ	VDD		V
Voltage on Input Pins	VIN	-0.3	VDD+0.3	V
Voltage on I/O Pins	VIO	-0.3	VDDQ+0.3	V
Power Dissipation	PD		1.6	W
Storage Temperature	tSTG	-65	150	°C
Operating Temperatures [Screening Levels]	/CT	0	70	°C
	/IT	-40	85	°C
	/ET	-40	105	°C
	/XT	-55	125	°C

*Stress greater than those listed under ABSOLUTE MAXIMUM RATINGS may cause permanent damage to the device. This is a stress rating only and functional operation of the device at these or any other conditions greater than those indicated in the operational sections of this specification is not implied. Exposure to absolute maximum conditions for any duration or segment of time may affect device reliability.

AC Test Loads

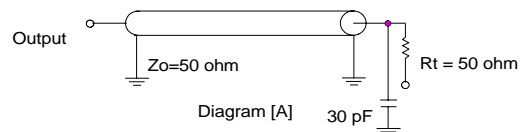

Vt= Termination Voltage
Rt= Termination Resistor
Vt= 1.50v for 3.3v VDDQ
Vt= 1.25v for 2.5v VDDQ

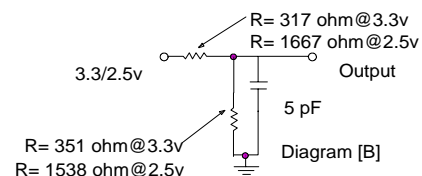



DC Electrical Characteristics (VDD=3.3v -5%/+10%,
TA= Min. and Max temperatures of Screening level chosen)

Symbol	Parameter	Test Conditions	Min	Max	Units	Notes	
VDD	Power Supply Voltage		3.135	3.630	V	1	
VDDQ	I/O Supply Voltage		2.375	VDD	V	1,5	
VoH	Output High Voltage	VDD=Min., IOH=-4mA	3.3v		V	1,4	
		VDD=Min., IOH=-1mA	2.5v		V	1,4	
VoL	Output Low Voltage	VDD=Min., IOL=8mA	3.3v	0.4	V	1,4	
		VDD=Min., IOL=1mA	2.5v	0.4	V	1,4	
VIH	Input High Voltage		3.3v	2	VDD+0.3	V	1,2
			2.5v	1.7	VDD+0.3	V	1,2
VIL	Input Low Voltage		3.3v	-0.3	0.8	V	1,2
			2.5v	-0.3	0.7	V	1,2
IIL	Input Leakage (except ZZ)	VDD=Max., VIN=VSS to VDD	-5	5	uA	3	
IZZL	Input Leakage, ZZ pin		-30	30	uA	3	
IOL	Output Leakage	Output Disabled, VOUT=VSSQ to VDDQ	-5	5	uA		
IDD	Operating Current	VDD=Max., f=Max., IOH=0mA		265	mA		
		5.0ns Cycle, 200 Mhz					
		6.0ns Cycle, 166 Mhz		240	mA		
		7.5ns Cycle, 133 Mhz		225	mA		
ISB1	Automatic CE. Power-down Current -TTL inputs	Max. VDD, Device De-Selected, VIN>=VIH or VIN<=VIL f=MAX=1/tCYC		110	mA		
		5.0ns Cycle, 200 Mhz					
		6.0ns Cycle, 166 Mhz		100	mA		
		7.5ns Cycle, 133 Mhz		90	mA		
ISB2	Automatic CE. Power-down Current - CMOS Inputs	Max. VDD, Device De-Selected, VIN<=0.3v or VIN>=VDDQ-0.3v f=MAX=1/tCYC		40	mA		
ISB4	Automatic CE. Power-down Current -TTL inputs	Max. VDD, Device De-Selected, VIN>=VIH or VIN <= VIL, f=0		45	mA		
ISB3	Automatic CE. Power-down Current - CMOS Inputs	Max. VDD, Device De-Selected, or VIN<=0.3v or VIN >=VDDQ-0.3v, f=Max=1/tCYC		95	mA		
		5.0ns Cycle, 200 Mhz					
		6.0ns Cycle, 166 Mhz		85	mA		
		7.5ns Cycle, 133 Mhz		75	mA		

Thermal Resistance

Symbol	Description	Conditions	Typical	Units	Notes	
θJA	Thermal Resistance (Junction to Ambient)	Test Conditions follow standard test methods and procedures for measuring thermal impedance, as per EIA/JESD51	1-Layer	42	°C/W	6
θJC	Thermal Resistance (Junction to Top of Case, Top)			9	°C/W	6

Notes:

- [1] All Voltages referenced to VSS (Logic Ground)
- [2] Overshoot: VIH < +4.6V for t<tKC/2 for I<20mA
Undershoot: VIL >-0.7V for t<tKC/2 for I<20mA
Power-up: VIH <+3.6V and VDD<3.135V for t<200ms
- [3] MODE and ZZ pins have internal pull-up resistors, and input leakage +/- +10uA
- [4] The load used for VOH, VOL testing is shown in Figure-2 for 3.3v and 2.5v supplies.
AC load current is higher than stated values, AC I/O curves can be made available upon request
- [5] VDDQ should never exceed VDD, VDD and VDDQ can be connected together
- [6] This parameter is sampled



AC Switching Characteristics (VDD=3.3v -5%/+10%,
TA= Min. and Max temperatures of Screening level chosen)

Parameter	Symbol	-26 [250Mhz]		-30 [200Mhz]		-35 [166Mhz]		-40 [133Mhz]		Units	Notes
		Min.	Max.	Min.	Max.	Min.	Max.	Min.	Max.		
Clock (CLK) Cycle Time	tCYC	4.00	-	5.00	-	6.00	-	7.50	-	ns	
Clock (CLK) High Time	tCH	1.70	-	2.00	-	2.50	-	3.00	-	ns	1
Clock (CLK) Low Time	tCL	1.70	-	2.00	-	2.50	-	3.00	-	ns	1
Clock Access Time	tCD	-	2.60	-	3.00	-	3.50	-	4.00	ns	2
Clock (CLK) High to Output Low-Z	tCLZ	1.25	-	1.25	-	1.25	-	1.25	-	ns	2,3,4,5
Clock High to Output High-Z	tCHZ	1.25	2.60	1.25	3.00	1.25	3.50	1.25	3.50	ns	2,3,4,5
Output Enable to Data Valid	tOE	-	2.60	-	3.00	-	3.50	-	4.00	ns	6
Output Hold from Clock High	tOH	1.25	-	1.25	-	1.25	-	1.25	-	ns	
Output Enable Low to Output Low-Z	tOELZ	0.00	-	0.00	-	0.00	-	0.00	-	ns	2,3,4,5
Output Enable High to Output High-Z	tOEHZ	-	2.60	-	3.00	-	3.50	-	3.50	ns	2,3,4,5
Address Set-up to CLK High	tAS	1.00	-	1.30	-	1.50	-	1.50	-	ns	7,8
Address Hold from CLK High	tAH	0.50	-	0.50	-	0.50	-	0.50	-	ns	7,8
Address Status Set-up to CLK High	tASS	1.00	-	1.30	-	1.50	-	1.50	-	ns	7,8
Address Status Hold from CLK High	tASH	0.50	-	0.50	-	0.50	-	0.50	-	ns	7,8
Address Advance Set-up to CLK High	tADVS	1.00	-	1.30	-	1.50	-	1.50	-	ns	7,8
Address Advance Hold from CLK High	tADVH	0.50	-	0.50	-	0.50	-	0.50	-	ns	7,8
Chip Enable Set-up to CLK High (CE\, CE2)	tCES	1.00	-	1.30	-	1.50	-	1.50	-	ns	7,8
Chip Enable Hold from CLK High (CE\, CE2)	tCEH	0.50	-	0.50	-	0.50	-	0.50	-	ns	7,8
Data Set-up to CLK High	tDS	1.00	-	1.30	-	1.50	-	1.50	-	ns	7,8
Data Hold from CLK High	tDH	0.50	-	0.50	-	0.50	-	0.50	-	ns	7,8
Write Set-up to CLK High (GW\, BWE\, BWX\)	tWES	1.00	-	1.30	-	1.50	-	1.50	-	ns	7,8
Write Hold from CLK High (GW\, BWE\, BWX\)	tWEH	0.50	-	0.50	-	0.50	-	0.50	-	ns	7,8
ZZ High to Power Down	tPD	-	2	-	2	-	2	-	2	cycles	
ZZ Low to Power Up	tPU	2	-	2	-	2	-	2	-	cycles	

Notes to Switching Specifications:

1. Measured as HIGH when above VIH and Low when below VIL
2. This parameter is measured with the output loading shown in AC Test Loads
3. This parameter is sampled
4. Transition is measured +500mV from steady state voltage
5. Critical specification(s) when Design Considerations are being reviewed/analyzed for Bus Contentention
6. OE\ is a Don't Care when a Byte or Global Write is sampled LOW
7. A READ cycle is defined by Byte or Global Writes sampled LOW and ADSP\ is sampled HIGH for the required SET-UP and HOLD times
8. This is a Synchronous device. All addresses must meet the specified SET-UP and HOLD times for all rising edges of CLK when either ADSP\ or ADSC\ is sampled LOW while the device is enabled. All other synchronous inputs must meet the SET-UP and HOLD times with stable logic levels for all rising edges of clock (CLK) during device operation (enabled). Chip Enable (Cex\, CE2) must be valid at each rising edge of clock (CLK) when either ADSP\ or ADSC\ is LOW to remain enabled.



AC Switching Waveforms
Write Cycle Timing

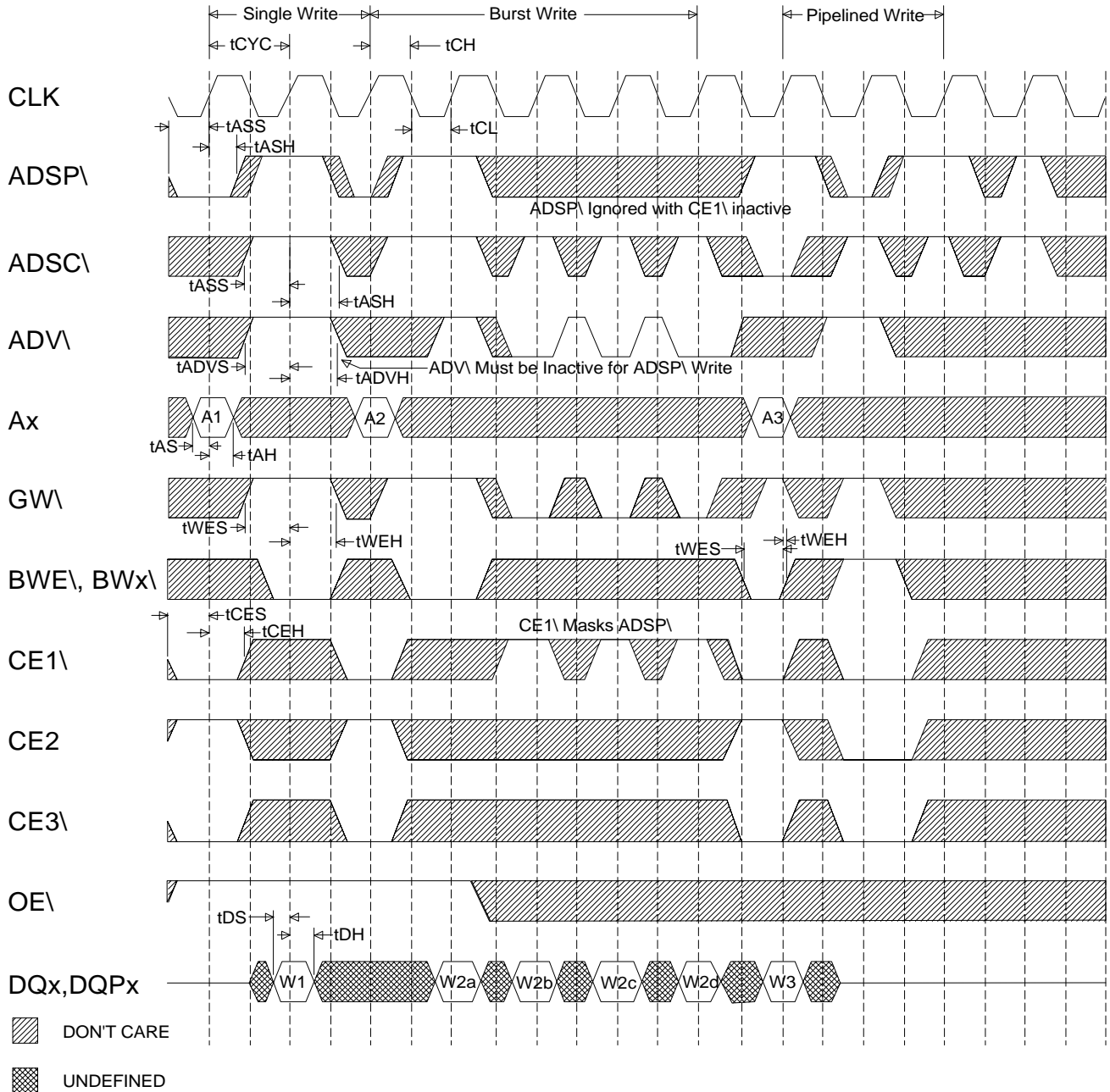



AC Switching Waveforms
Read Cycle Timing

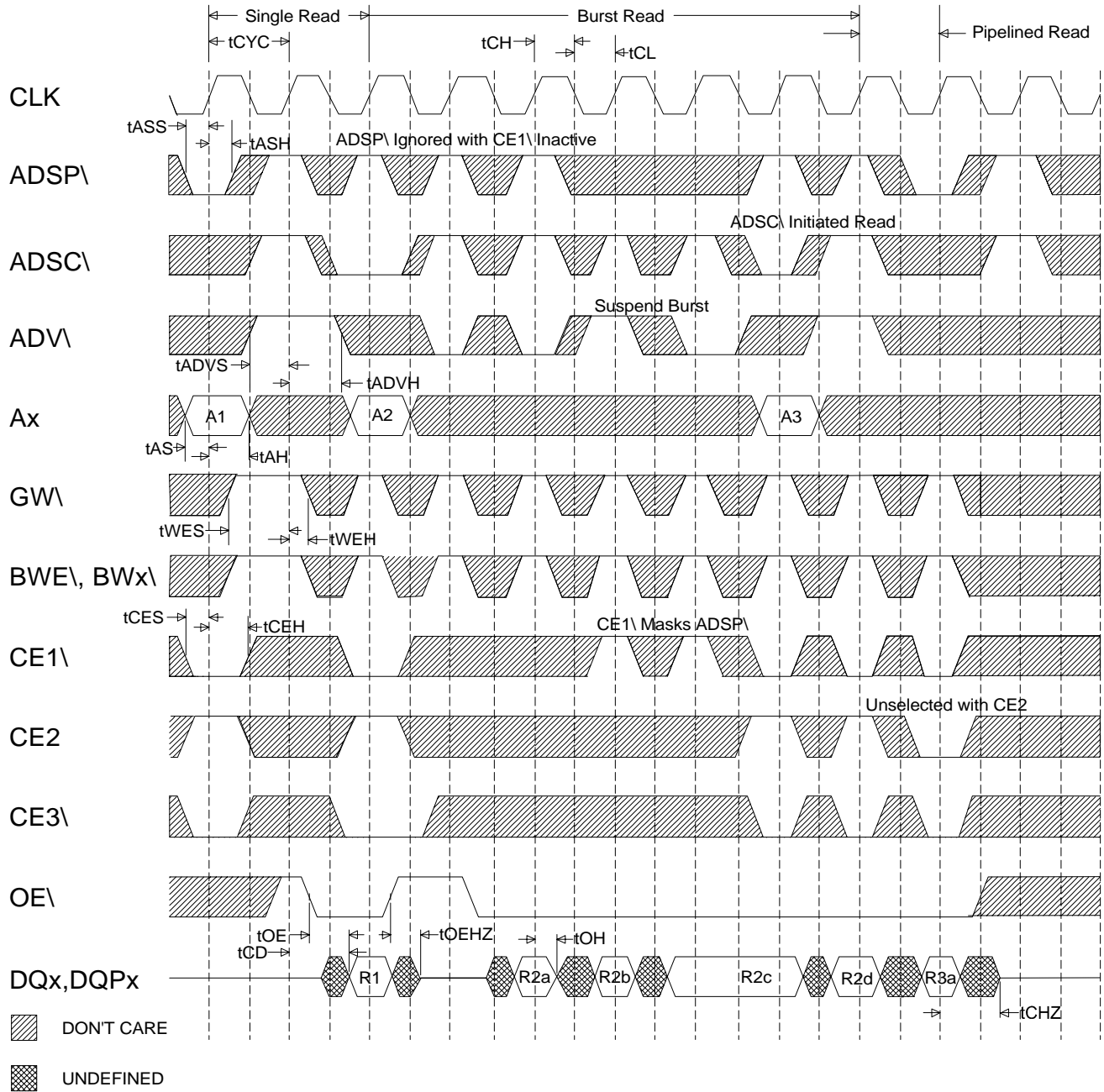



AC Switching Waveforms
Read/Write Cycle Timing

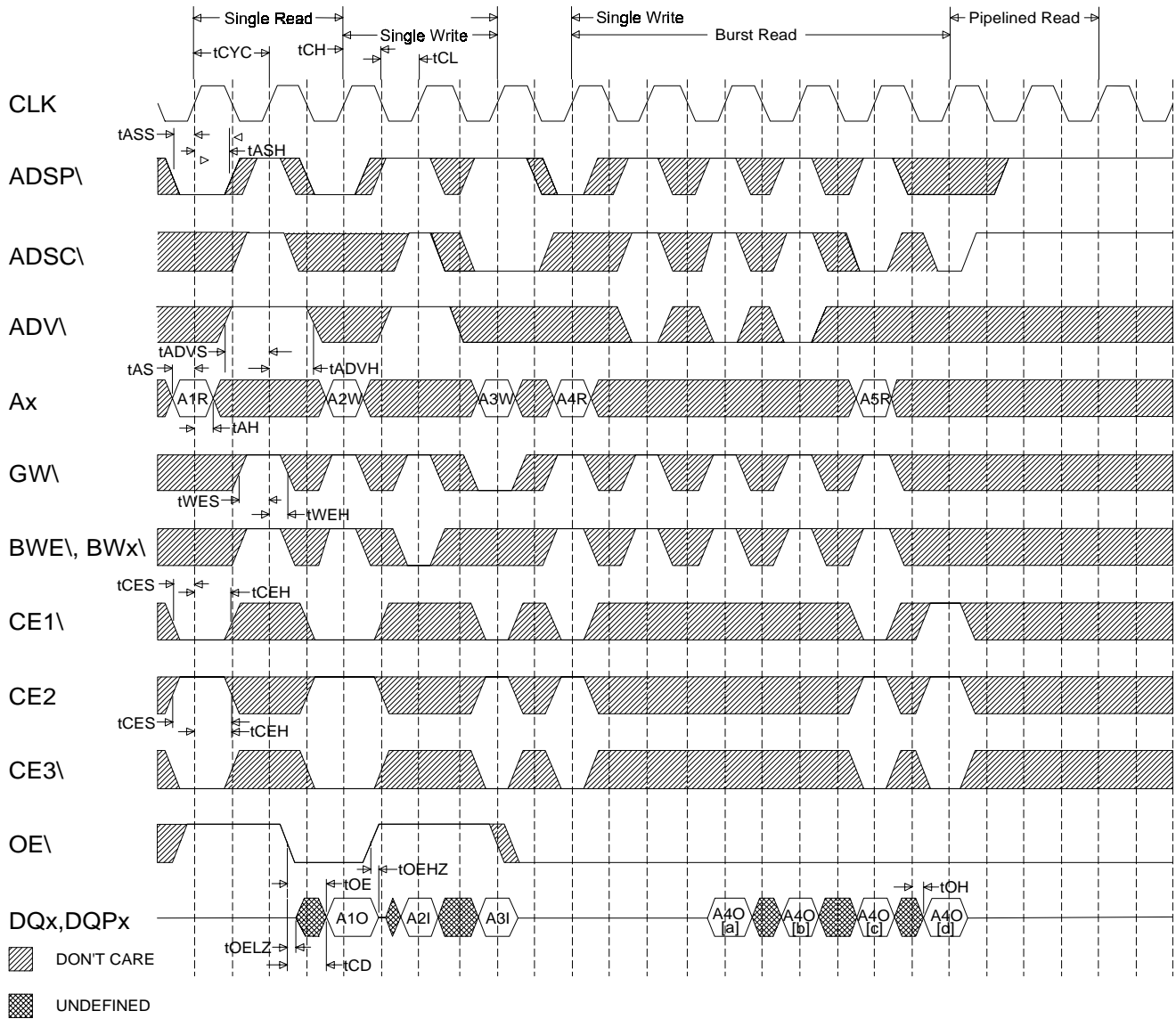



Power Down (SNOOZE MODE)

Power Down or Snooze is a Power conservation mode which when building large/very dense arrays, using multiple devices in a multi-banked or paged array, can greatly reduce the Operating current requirements of your total memory array solution.

The device is placed in this mode via the use of the ZZ pin, an asynchronous control pin which when asserted, places the array into the lower power or Power Down mode. Awakening the array or leaving the Power Down (SNOOZE) mode is done so by de-asserting the ZZ pin .

While in the Power Down or Snooze mode, Data integrity is guaranteed. Accesses pending when the device entered the mode are not considered valid nor is the completion of the operation guaranteed. The device must be de-selected prior to entering the Power Down mode, all Chip Enables, ADSP\ and ADSC\ must remain inactive for the duration of ZZ recovery time (tZZREC).

Ordering Information

ASI Part Number	Configuration	tCD (ns)	Clock (Mhz)
Industrial Operating Range (-40°C to +85°C)			
AS5SP128K36DQ-30IT	128Kx36, 3.3vCore/3.3,2.5vIO	3.0	200
AS5SP128K36DQ-35IT	128Kx36, 3.3vCore/3.3,2.5vIO	3.5	166
AS5SP128K36DQ-40IT	128Kx36, 3.3vCore/3.3,2.5vIO	4.0	133
Enhanced Operating Range (-40°C to +105°C)			
AS5SP128K36DQ-30ET	128Kx36, 3.3vCore/3.3,2.5vIO	3.0	200
AS5SP128K36DQ-35ET	128Kx36, 3.3vCore/3.3,2.5vIO	3.5	166
AS5SP128K36DQ-40ET	128Kx36, 3.3vCore/3.3,2.5vIO	4.0	133
Extended Operating Range (-55°C to +125°C)			
AS5SP128K36DQ-35XT	128Kx36, 3.3vCore/3.3,2.5vIO	3.5	166
AS5SP128K36DQ-40XT	128Kx36, 3.3vCore/3.3,2.5vIO	4.0	133

ZZ Mode Electrical Characteristics

Parameter	Symbol	Test Conditon	Min.	Max.	Units
Power Down (SNOOZE) Mode	IDDzz	ZZ >/- VDD - 0.2V		10	mA
ZZ Active (Signal HIGH) to Power Down	tZZS	ZZ >/- VDD - 0.2V		2 tCYC	ns
ZZ Inactive (Signal Low) to Power Up	tZZR	ZZ </- 0.2V	2 tCYC		ns

ZZ Mode Timing Diagram

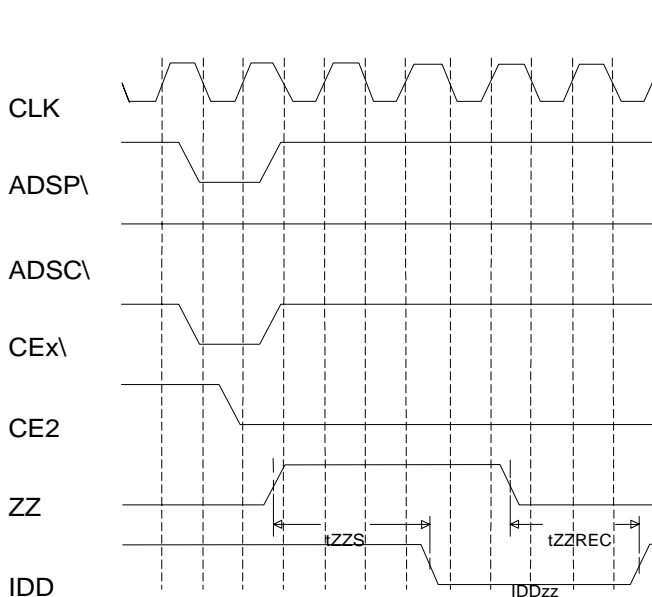

Mechanical Diagram

