

T-27-01

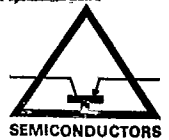

# SILICON TRANSISTORS

Maximum Ratings

Electrical Characteristics At  $T_J = 25^\circ\text{C}$

TYPE	Pd $T_a = 25^\circ\text{C}$ W	V <sub>CB0</sub> V	V <sub>CE0</sub> V	V <sub>EB0</sub> V	I <sub>C</sub> mA	h <sub>FE</sub> @ min/max	V <sub>CE</sub> /I <sub>C</sub> V/mA	V <sub>CE (sat)</sub> @ max V	I <sub>C</sub> /I <sub>B</sub> @ I <sub>C</sub> =10 mA I <sub>B</sub> =0.5 mA	f <sub>T</sub> (typ) MHz	I <sub>CB0</sub> (typ) nA	C <sub>ob</sub> (typ) pF	Case
SG331	SF331	0.2	60	60	5	200	50/150	4/1	0.3	200	100	3	TO-106
SG332	SF332	0.2	60	60	5	200	100/300	4/1	0.3	200	100	3	TO-106
SG840	SF840	0.2	40	40	5	200	200/-	4/1	0.3	200	100	3	TO-106

SF/SG 300 Series and SF/SG 840 are low level transistors tested for h<sub>FE</sub> at I<sub>C</sub> = 10μA also.

GAIN GROUPS	SF/SG 104	Red Orange Yellow Green	30-70 70-100 100-140 140-200	Blue Violet Grey	200-280 280-400 400 Up	SF/SG '118	Blue Violet/Grey	200-280 280-560
-------------	-----------	----------------------------------	---------------------------------------	------------------------	------------------------------	------------	---------------------	--------------------

TR

## (b) General purpose amplifiers

Maximum Ratings

Electrical Characteristics At  $T_J = 25^\circ\text{C}$

TYPE	Pd $T_a = 25^\circ\text{C}$ W	Pd $T_a = 25^\circ\text{C}$ W	V <sub>CB0</sub> V	V <sub>CE0</sub> V	V <sub>EB0</sub> V	I <sub>C</sub> mA	h <sub>FE</sub> @ min/max	V <sub>CE</sub> /I <sub>C</sub> V/mA	V <sub>CE (sat)</sub> @ max V	I <sub>C</sub> /I <sub>B</sub> @ I <sub>C</sub> /I <sub>B</sub>	f <sub>T</sub> min MHz	I <sub>CB0</sub> max nA	C <sub>ob</sub> max pF	Case
2N 697	0.6	2	60	40*	5	500	50/120	10/150	1.5	150/15	50	1000	35	TO-39
2N 698	0.6	2	120	60	7	500	20/60	10/150	5	150/15	40	5	35	TO-39
2N 699	0.6	2	120	80*	5	500	40/120	10/150	5	150/15	50	2000	15	TO-39
2N 718	0.4	1.5	60	40*	5	500	40/120	10/150	1.5	150/15	50	1000	35	TO-18
2N 720	0.4	1.5	120	80*	5	500	40/120	10/150	5	150/15	50	2000	20	TO-18
2N 869	0.36	1.2	25	18	5	200	20/-	5/10	1	5/10	250	10	9	TO-18
2N 910	0.5	1.8	100	60	7	500	75/-	10/10	1.2	50/5	60	25	15	TO-18
2N 911	0.5	1.8	100	60	7	500	35/-	10/10	1.2	50/5	50	25	15	TO-18
2N 915	0.36	1.2	70	50	5	100	50/200	5/10	1	10/1	250	10	3.5	TO-18
2N 916	0.36	1.2	45	25	5	100	50/200	1/10	0.5	10/1	250	10	6	TO-18
2N 929	0.3	1.8	45	45	5	30	40/120	5/0.01	1	10/0.5	30	10	8	TO-18
2N 930	0.3	1.8	45	45	5	30	100/300	5/0.01	1	10/0.5	30	10	8	TO-18
2N 1481	0.8	5	60	40	12	1500	35/100	4/200	-	-	1.5	10	-	TO-39
2N 1482	0.8	5	100	55	12	1500	35/100	4/200	-	-	1.5	10	-	TO-39
2N 1613	0.8	3	75	50*	7	1000	40/120	10/150	1.5	150/15	60	10	25	TO-39
2N 1711	0.8	3	75	50*	7	1000	100/300	10/150	1.5	150/15	70	10	25	TO-39
2N 1893	0.8	3	120	80	7	500	40/120	10/150	5	150/15	50	10	15	TO-39
2N 2102	1	5	120	65	7	1000	40/120	10/150	0.5	150/15	60	2	15	TO-39
2N 2243	0.8	3	120	80	7	1000	40/120	10/150	0.35	150/15	50	10	15	TO-39
2N 2270	1	5	60	45	7	1000	50/200	10/150	0.9	150/15	100	50	15	TO-39
2N 3019	0.8	5	140	80	7	1000	100/300	10/150	0.2	150/15	100	10	12	TO-39
2N 3020	0.8	5	140	80	7	1000	40/120	10/150	0.2	150/15	80	10	12	TO-39
2N 3053	0.8	5	60	40	5	700	50/250	10/150	1.4	150/15	100	-	15	TO-39
2N 3700	0.5	1.8	140	80	7	1000	100/300	10/150	0.2	150/15	100	10	12	TO-18

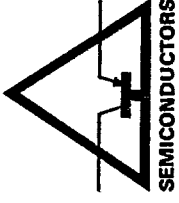

# CASE OUTLINES

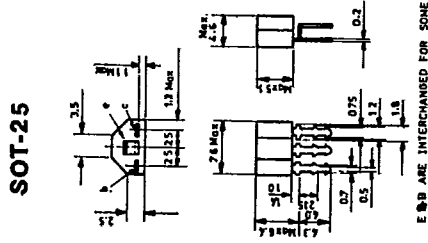
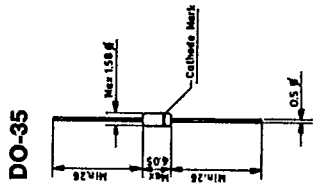
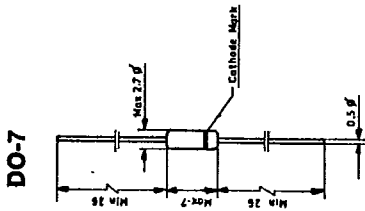

E & B ARE INTERCHANGED FOR SOME DEVICES

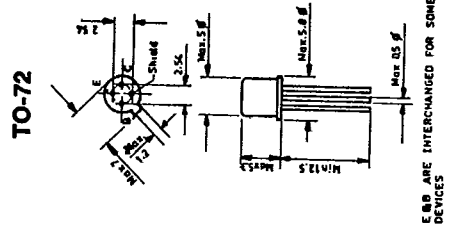
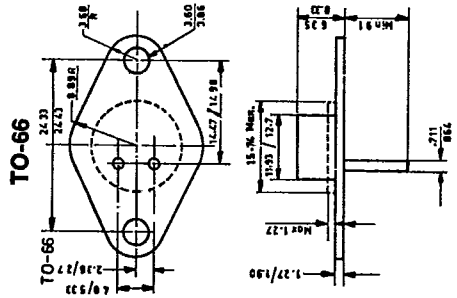
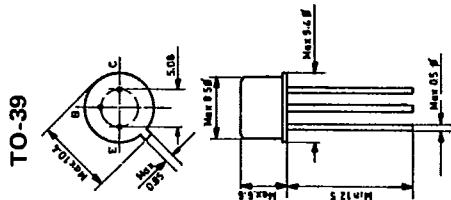
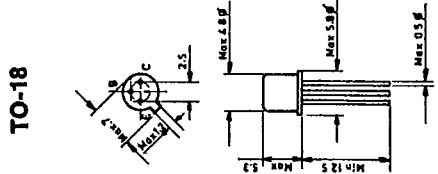
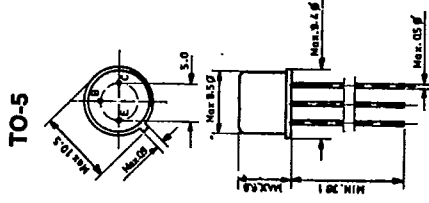
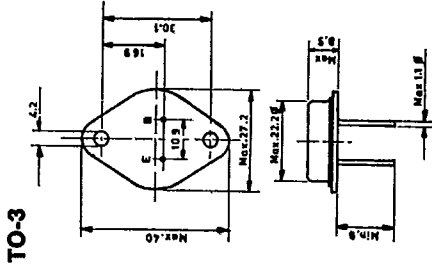

E & B ARE INTERCHANGED FOR SOME DEVICES

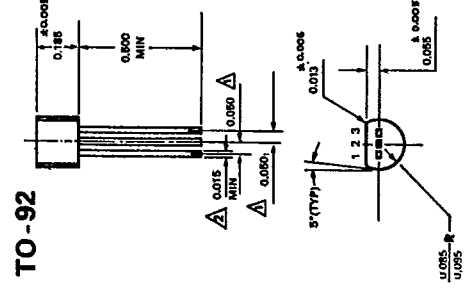

(Dimensions in inches)

Note : Dimensions in mm unless otherwise specified

TO-96

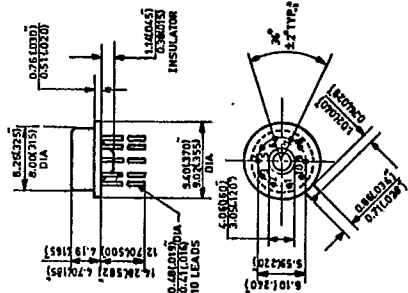

TO-99

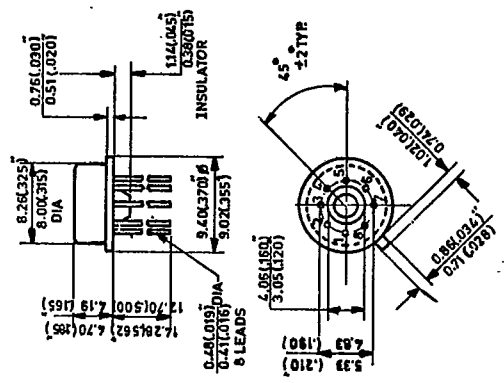

TO-105

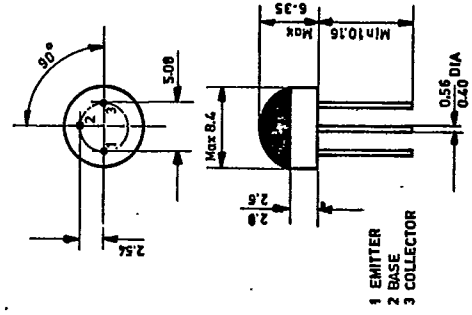

TO-106

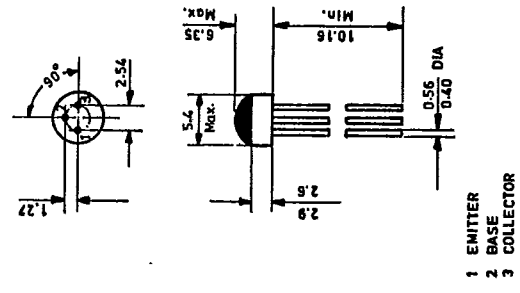

TO-220

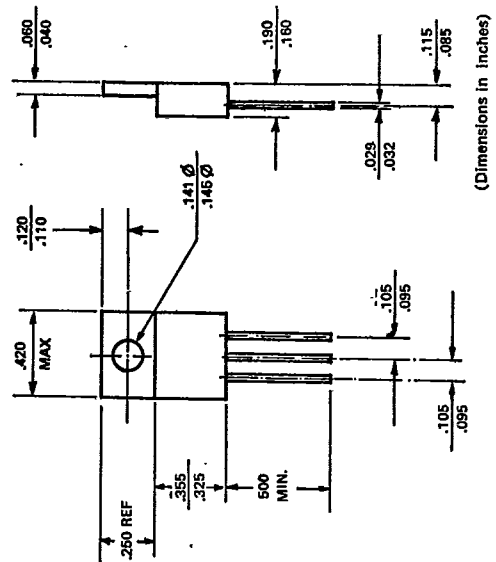

14 pin DIP

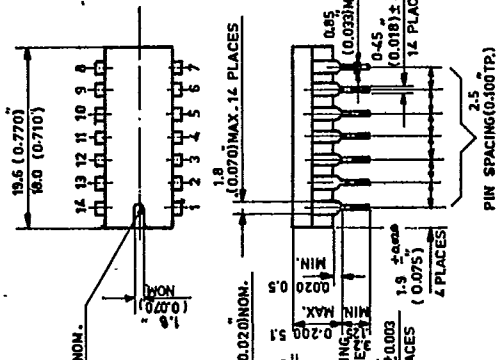

16 pin DIP

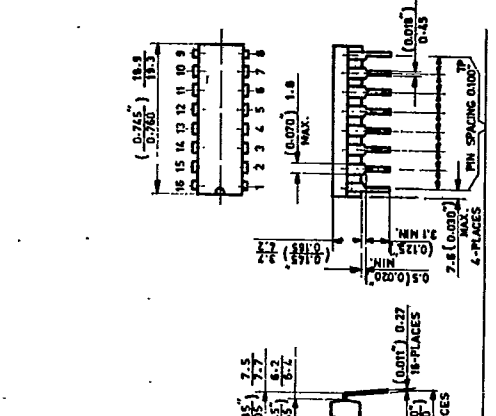

Note : Dimensions in mm unless otherwise specified