

TLC271, TLC271A, TLC271B LinCMOS™ PROGRAMMABLE LOW-POWER OPERATIONAL AMPLIFIERS

SLOS080A – NOVEMBER 1987 – REVISED AUGUST 1994

- **Input Offset Voltage Drift . . . Typically 0.1 μ V/Month, Including the First 30 Days**
- **Wide Range of Supply Voltages Over Specified Temperature Range:**
 0°C to 70°C . . . 3 V to 16 V
 -40°C to 85°C . . . 4 V to 16 V
 -55°C to 125°C . . . 5 V to 16 V
- **Single-Supply Operation**
- **Common-Mode Input Voltage Range Extends Below the Negative Rail (C-Suffix and I-Suffix Types)**
- **Low Noise . . . 25 nV/ $\sqrt{\text{Hz}}$ Typically at $f = 1$ kHz (High-Bias Mode)**
- **Output Voltage Range includes Negative Rail**
- **High Input Impedance . . . $10^{12} \Omega$ Typ**
- **ESD-Protection Circuitry**
- **Small-Outline Package Option Also Available In Tape and Reel**
- **Designed-In Latch-Up Immunity**

D, JG, OR P PACKAGE
(TOP VIEW)

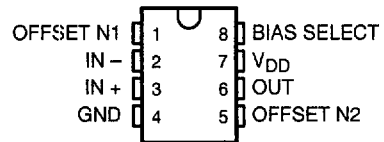

FK PACKAGE
(TOP VIEW)

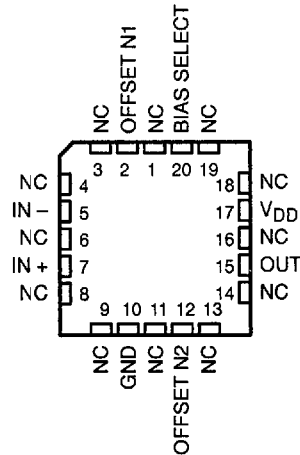

NC -- No internal connection

description

The TLC271 operational amplifier combines a wide range of input offset voltage grades with low offset voltage drift and high input impedance. In addition, the TLC271 offers a bias-select mode that allows the user to select the best combination of power dissipation and ac performance for a particular application. These devices use Texas Instruments silicon-gate LinCMOS™ technology, which provides offset voltage stability far exceeding the stability available with conventional metal-gate processes.

AVAILABLE OPTIONS

TA	V _{IOmax} AT 25°C	PACKAGE			
		SMALL OUTLINE (D)	CHIP CARRIER (FK)	CERAMIC DIP (JG)	PLASTIC DIP (P)
0°C to 70°C	2 mV 5 mV 10 mV	TLC271BCD TLC271ACD TLC271CD	—	—	TLC271BCP TLC271ACP TLC271CP
-40°C to 85°C	2 mV 5 mV 10 mV	TLC271BID TLC271AID TLC271ID	—	—	TLC271BIP TLC271AIP TLC271IP
-55°C to 125°C	10 mV	TLC271MD	TLC271MFK	TLC271MJG	TLC271MP

The D package is available taped and reeled. Add R suffix to the device type (e.g., TLC271BCDR).

LinCMOS is a trademark of Texas Instruments Incorporated.

PRODUCTION DATA information is current as of publication date. Products conform to specifications per the terms of Texas Instruments standard warranty. Production processing does not necessarily include testing of all parameters.



POST OFFICE BOX 655303 • DALLAS, TEXAS 75235

Copyright © 1994, Texas Instruments Incorporated

TLC271, TLC271A, TLC271B LinCMOS™ PROGRAMMABLE LOW-POWER OPERATIONAL AMPLIFIERS

SLOS090A – NOVEMBER 1987 – REVISED AUGUST 1994

DEVICE FEATURES

PARAMETER†	BIAS-SELECT MODE			UNIT
	HIGH	MEDIUM	LOW	
P_D	3375	525	50	μW
SR	3.6	0.4	0.03	V/ μs
V_n	25	32	68	nV/ \sqrt{Hz}
B_1	1.7	0.5	0.09	MHz
A_{VD}	23	170	480	V/mV

† Typical at $V_{DD} = 5 V$, $T_A = 25^\circ C$

description (continued)

Using the bias-select option, these cost-effective devices can be programmed to span a wide range of applications that previously required BIFET, NFET or bipolar technology. Three offset voltage grades are available (C-suffix and I-suffix types), ranging from the low-cost TLC271 (10 mV) to the TLC271B (2 mV) low-offset version. The extremely high input impedance and low bias currents, in conjunction with good common-mode rejection and supply voltage rejection, make these devices a good choice for new state-of-the-art designs as well as for upgrading existing designs.

In general, many features associated with bipolar technology are available in LinCMOS™ operational amplifiers, without the power penalties of bipolar technology. General applications such as transducer interfacing, analog calculations, amplifier blocks, active filters, and signal buffering are all easily designed with the TLC271. The devices also exhibit low-voltage single-supply operation, making them ideally suited for remote and inaccessible battery-powered applications. The common-mode input voltage range includes the negative rail.

A wide range of packaging options is available, including small-outline and chip-carrier versions for high-density system applications.

The device inputs and output are designed to withstand -100 -mA surge currents without sustaining latch-up.

The TLC271 incorporates internal ESD-protection circuits that prevent functional failures at voltages up to 2000 V as tested under MIL-STD-883C, Method 3015.2; however, care should be exercised in handling these devices as exposure to ESD may result in the degradation of the device parametric performance.

The C-suffix devices are characterized for operation from $0^\circ C$ to $70^\circ C$. The I-suffix devices are characterized for operation from $-40^\circ C$ to $85^\circ C$. The M-suffix devices are characterized for operation over the full military temperature range of $-55^\circ C$ to $125^\circ C$.

bias-select feature

The TLC271 offers a bias-select feature that allows the user to select any one of three bias levels depending on the level of performance desired. The tradeoffs between bias levels involve ac performance and power dissipation (see Table 1).

bias-select feature (continued)

Table 1. Effect of Bias Selection on Performance

TYPICAL PARAMETER VALUES $T_A = 25^\circ\text{C}$, $V_{DD} = 5\text{ V}$		MODE			UNIT
		HIGH BIAS $R_L = 10\text{ k}\Omega$	MEDIUM BIAS $R_L = 100\text{ k}\Omega$	LOW BIAS $R_L = 1\text{ M}\Omega$	
P_D	Power dissipation	3.4	0.5	0.05	mW
SR	Slew rate	3.6	0.4	0.03	V/ μs
V_n	Equivalent input noise voltage at $f = 1\text{ kHz}$	25	32	68	nV/ $\sqrt{\text{Hz}}$
B_1	Unity-gain bandwidth	1.7	0.5	0.09	MHz
ϕ_m	Phase margin	46°	40°	34°	
A_{VD}	Large-signal differential voltage amplification	23	170	480	V/mV

bias selection

Bias selection is achieved by connecting the bias select pin to one of three voltage levels (see Figure 1). For medium-bias applications, it is recommended that the bias select pin be connected to the midpoint between the supply rails. This procedure is simple in split-supply applications, since this point is ground. In single-supply applications, the medium-bias mode necessitates using a voltage divider as indicated in Figure 1. The use of large-value resistors in the voltage divider reduces the current drain of the divider from the supply line. However, large-value resistors used in conjunction with a large-value capacitor require significant time to charge up to the supply midpoint after the supply is switched on. A voltage other than the midpoint can be used if it is within the voltages specified in Figure 1.

bias selection (continued)

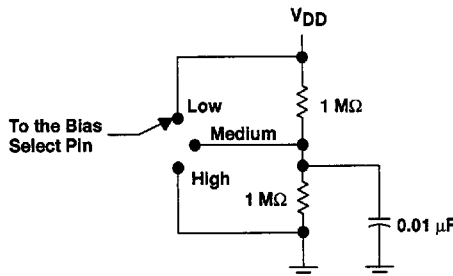

BIAS MODE	BIAS-SELECT VOLTAGE (single supply)
Low	V_{DD}
Medium	1 V to $V_{DD} - 1\text{ V}$
High	GND

Figure 1. Bias Selection for Single-Supply Applications

high-bias mode

In the high-bias mode, the TLC271 series features low offset voltage drift, high input impedance, and low noise. Speed in this mode approaches that of BiFET devices but at only a fraction of the power dissipation. Unity-gain bandwidth is typically greater than 1 MHz.

medium-bias mode

The TLC271 in the medium-bias mode features low offset voltage drift, high input impedance, and low noise. Speed in this mode is similar to general-purpose bipolar devices but power dissipation is only a fraction of that consumed by bipolar devices.

TLC271, TLC271A, TLC271B

LinCMOS™ PROGRAMMABLE LOW-POWER OPERATIONAL AMPLIFIERS

SLOS090A – NOVEMBER 1987 – REVISED AUGUST 1994

low-bias mode

In the low-bias mode, the TLC271 features low offset voltage drift, high input impedance, extremely low power consumption, and high differential voltage gain.

ORDER OF CONTENTS

TOPIC	BIAS MODE
schematic	all
absolute maximum ratings	all
recommended operating conditions	all
electrical characteristics operating characteristics typical characteristics	high (Figures 2 – 33)
electrical characteristics operating characteristics typical characteristics	medium (Figures 34 – 65)
electrical characteristics operating characteristics typical characteristics	low (Figures 66 – 97)
parameter measurement information	all
application information	all

equivalent schematic

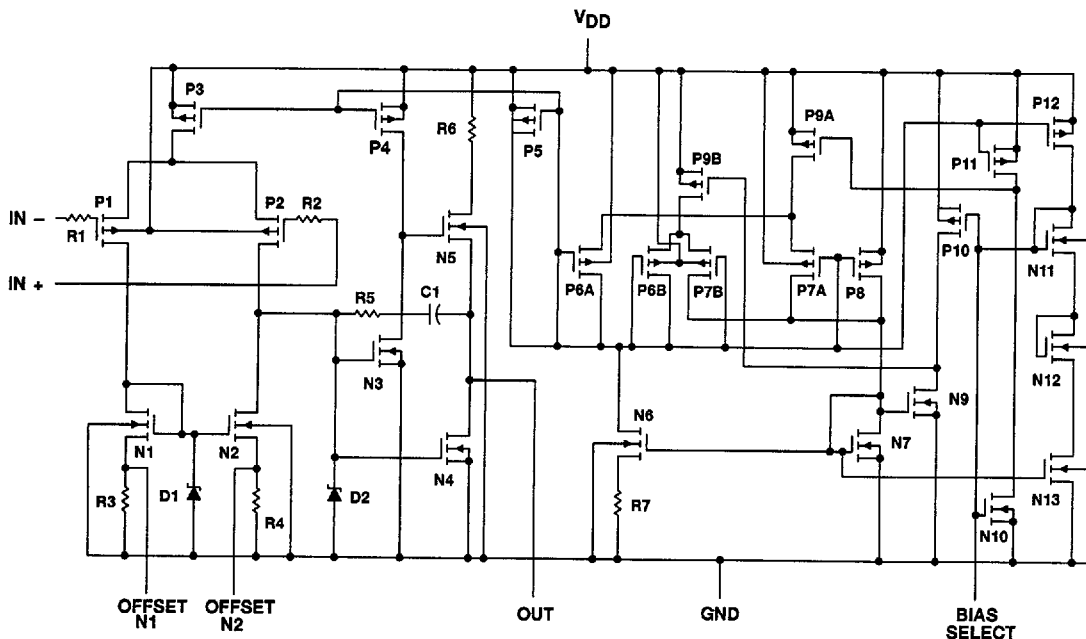

POST OFFICE BOX 655303 • DALLAS, TEXAS 75265

TLC271, TLC271A, TLC271B
LinCMOS™ PROGRAMMABLE LOW-POWER
OPERATIONAL AMPLIFIERS

SLOS090A – NOVEMBER 1987 – REVISED AUGUST 1994

absolute maximum ratings over operating free-air temperature (unless otherwise noted)†

Supply voltage, V_{DD} (see Note 1)	8 V
Differential input voltage, V_{ID} (see Note 2)	$\pm V_{DD}$
Input voltage range, V_I (any input)	-0.3 V to V_{DD}
Input current, I_I	± 5 mA
Output current, I_O	± 30 mA
Duration of short-circuit current at (or below) 25°C (see Note 3)	Unlimited
Continuous total dissipation	See Dissipation Rating Table
Operating free-air temperature, T_A : C suffix	0°C to 70°C
I suffix	-40°C to 85°C
M suffix	-55°C to 125°C
Storage temperature range	-65°C to 150°C
Case temperature for 60 seconds: FK package	260°C
Lead temperature 1,6 mm (1/16 inch) from case for 10 seconds: D or P package	260°C
Lead temperature 1,6 mm (1/16 inch) from case for 60 seconds: JG package	300°C

† Stresses beyond those listed under "absolute maximum ratings" may cause permanent damage to the device. These are stress ratings only, and functional operation of the device at these or any other conditions beyond those indicated under "recommended operating conditions" is not implied. Exposure to absolute-maximum-rated conditions for extended periods may affect device reliability.

- NOTES: 1. All voltage values, except differential voltages, are with respect to network ground.
 2. Differential voltages are at IN+ with respect to IN-.
 3. The output may be shorted to either supply. Temperature and/or supply voltages must be limited to ensure that the maximum dissipation rating is not exceeded (see application section).

DISSIPATION RATING TABLE

PACKAGE	$T_A \leq 25^\circ\text{C}$	DERATING FACTOR ABOVE $T_A = 25^\circ\text{C}$	$T_A = 70^\circ\text{C}$	$T_A = 85^\circ\text{C}$	$T_A = 125^\circ\text{C}$
	POWER RATING		POWER RATING	POWER RATING	POWER RATING
D	725 mW	5.8 mW/°C	464 mW	377 mW	145 mW
FK	1375 mW	11.0 mW/°C	880 mW	715 mW	275 mW
JG	1050 mW	8.4 mW/°C	672 mW	546 mW	210 mW
P	1000 mW	8.0 mW/°C	640 mW	520 mW	200 mW

recommended operating conditions

		C SUFFIX		I SUFFIX		M SUFFIX		UNIT
		MIN	MAX	MIN	MAX	MIN	MAX	
Supply voltage, V_{DD}		3	16	4	16	5	16	V
Common-mode input voltage, V_{IC}	$V_{DD} = 5$ V	-0.2	3.5	-0.2	3.5	0	3.5	V
	$V_{DD} = 10$ V	-0.2	8.5	-0.2	8.5	0	8.5	
Operating free-air temperature, T_A		0	70	-40	85	-55	125	°C



1ST OFFICE BOX 655303 • DALLAS, TEXAS 75265

TLC271, TLC271A, TLC271B
LinCMOS™ PROGRAMMABLE LOW-POWER
OPERATIONAL AMPLIFIERS

SLOS090A – NOVEMBER 1987 – REVISED AUGUST 1994

HIGH-BIAS MODE

electrical characteristics at specified free-air temperature (unless otherwise noted)

PARAMETER		TEST CONDITIONS	T _A †	TLC271C, TLC271AC, TLC271BC						UNIT	
				V _{DD} = 5 V			V _{DD} = 10 V				
				MIN	TYP	MAX	MIN	TYP	MAX		
V _{IO}	Input offset voltage	TLC271C	V _O = 1.4 V, V _{IC} = 0 V, R _S = 50 Ω, R _L = 10 kΩ	25°C		1.1	10		1.1	10	mV
				Full range			12		12		
				25°C		0.9	5		0.9	5	
				Full range			6.5		6.5		
				25°C		0.34	2		0.39	2	
				Full range			3		3		
α _{VIO}	Average temperature coefficient of input offset voltage		25°C to 70°C		1.8		2		μV/°C		
I _{IO}	Input offset current (see Note 4)	V _O = V _{DD} /2, V _{IC} = V _{DD} /2	25°C		0.1			0.1		pA	
			70°C		7	300		7	300		
I _{IB}	Input bias current (see Note 4)	V _O = V _{DD} /2, V _{IC} = V _{DD} /2	25°C		0.6			0.7		pA	
			70°C		40	600		50	600		
V _{ICR}	Common-mode input voltage range (see Note 5)		25°C	-0.2 to 4	-0.3 to 4.2			-0.2 to 9	-0.3 to 9.2	V	
			Full range	-0.2 to 3.5			-0.2 to 8.5		V		
V _{OH}	High-level output voltage	V _{ID} = 100 mV, R _L = 10 kΩ	25°C	3.2	3.8		8	8.5		V	
			0°C	3	3.8		7.8	8.5			
			70°C	3	3.8		7.8	8.4			
V _{OL}	Low-level output voltage	V _{ID} = -100 mV, I _{OL} = 0	25°C		0	50		0	50	mV	
			0°C		0	50		0	50		
			70°C		0	50		0	50		
A _{VD}	Large-signal differential voltage amplification	R _L = 10 kΩ, See Note 6	25°C	5	23		10	36		V/mV	
			0°C	4	27		7.5	42			
			70°C	4	20		7.5	32			
CMRR	Common-mode rejection ratio	V _{IC} = V _{ICRmin}	25°C	65	80		65	85		dB	
			0°C	60	84		60	88			
			70°C	60	85		60	88			
k _{SVR}	Supply-voltage rejection ratio (ΔV _{DD} /ΔV _{IO})	V _O = 1.4 V	25°C	65	95		65	95		dB	
			0°C	60	94		60	94			
			70°C	60	96		60	96			
I _{I(SEL)}	Input current (BIAS SELECT)	V _{I(SEL)} = 0	25°C		-1.4			-1.9	μA		
I _{DD}	Supply current	V _O = V _{DD} /2, V _{IC} = V _{DD} /2, No load	25°C		675	1600		950	2000	μA	
			0°C		775	1800		1125	2200		
			70°C		575	1300		750	1700		

† Full range is 0°C to 70°C.

NOTES: 4. The typical values of input bias current and input offset current below 5 pA were determined mathematically.

5. This range also applies to each input individually.

6. At V_{DD} = 5 V, V_O = 0.25 V to 2 V; at V_{DD} = 10 V, V_O = 1 V to 6 V.



HIGH-BIAS MODE

electrical characteristics at specified free-air temperature (unless otherwise noted)

PARAMETER		TEST CONDITIONS	T _A †	TLC271, TLC271A, TLC271B						UNIT		
				V _{DD} = 5 V			V _{DD} = 10 V					
				MIN	TYP	MAX	MIN	TYP	MAX			
V _{IO}	Input offset voltage	TLC271I V _O = 1.4 V, V _{IC} = 0 V, R _S = 50 Ω, R _L = 10 kΩ	25°C	1.1		10		1.1		10		mV
			Full range	13			13					
			25°C	0.9		5		0.9		5		
			Full range	7			7					
			25°C	0.34		2		0.39		2		
			Full range	3.5			3.5					
α _{VIO}	Average temperature coefficient of input offset voltage		25°C to 85°C	1.8		2					μV/°C	
I _{IO}	Input offset current (see Note 4)	V _O = V _{DD} /2, V _{IC} = V _{DD} /2	25°C	0.1		0.1						pA
			85°C	24		1000		26		1000		
I _{IB}	Input bias current (see Note 4)	V _O = V _{DD} /2, V _{IC} = V _{DD} /2	25°C	0.6		0.7						pA
			85°C	200		2000		220		2000		
V _{ICR}	Common-mode input voltage range (see Note 5)		25°C	-0.2 to 4	-0.3 to 4.2	-0.2 to 9		-0.3 to 9.2				V
			Full range	-0.2 to 3.5		-0.2 to 8.5						
V _{OH}	High-level output voltage	V _{ID} = 100 mV, R _L = 10 kΩ	25°C	3.2		3.8		8		8.5		V
			-40°C	3		3.8		7.8		8.5		
			85°C	3		3.8		7.8		8.5		
V _{OL}	Low-level output voltage	V _{ID} = -100 mV, I _{OL} = 0	25°C	0		50		0		50		mV
			-40°C	0		50		0		50		
			85°C	0		50		0		50		
A _{VD}	Large-signal differential voltage amplification	R _L = 10 kΩ, See Note 6	25°C	5		23		10		36		V/mV
			-40°C	3.5		32		7		46		
			85°C	3.5		19		7		31		
CMRR	Common-mode rejection ratio	V _{IC} = V _{ICRmin}	25°C	65		80		65		85		dB
			-40°C	60		81		60		87		
			85°C	60		86		60		88		
K _{SVR}	Supply-voltage rejection ratio (ΔV _{DD} /ΔV _{IO})	V _O = 1.4 V	25°C	65		95		65		95		dB
			-40°C	60		92		60		92		
			85°C	60		96		60		96		
I _{I(SEL)}	Input current (BIAS SELECT)	V _{I(SEL)} = 0	25°C	-1.4		-1.9						μA
I _{DD}	Supply current	V _O = V _{DD} /2, V _{IC} = V _{DD} /2, No load	25°C	675		1600		950		2000		μA
			-40°C	950		2200		1375		2500		
			85°C	525		1200		725		1600		

† Full range is -40°C to 85°C.

NOTES: 4. The typical values of input bias current and input offset current below 5 pA were determined mathematically.

5. This range also applies to each input individually.

6. At V_{DD} = 5 V, V_O = 0.25 V to 2 V; at V_{DD} = 10 V, V_O = 1 V to 6 V.

TLC271, TLC271A, TLC271B LinCMOS™ PROGRAMMABLE LOW-POWER OPERATIONAL AMPLIFIERS

SLOS090A – NOVEMBER 1987 – REVISED AUGUST 1994

HIGH-BIAS MODE

electrical characteristics at specified free-air temperature (unless otherwise noted)

PARAMETER	TEST CONDITIONS	T _A †	TLC271M						UNIT
			V _{DD} = 5 V			V _{DD} = 10 V			
			MIN	TYP	MAX	MIN	TYP	MAX	
V _{IO} Input offset voltage	V _O = 1.4 V, V _{IC} = 0 V, R _S = 50 Ω, R _L = 10 kΩ	25°C	1.1		10	1.1		10	mV
		Full range			12			12	
α _{VIO} Average temperature coefficient of input offset voltage		25°C to 125°C	2.1			2.2			μV/°C
I _{IO} Input offset current (see Note 4)	V _O = V _{DD} /2, V _{IC} = V _{DD} /2	25°C	0.1			0.1			pA
		125°C	1.4		15	1.8		15	nA
I _{IB} Input bias current (see Note 4)	V _O = V _{DD} /2, V _{IC} = V _{DD} /2	25°C	0.6			0.7			pA
		125°C	9		35	10		35	nA
V _{ICR} Common-mode input voltage range (see Note 5)		25°C	0 to 4	-0.3 to 4.2		0 to 9	-0.3 to 9.2		V
		Full range	0 to 3.5			0 to 8.5			V
V _{OH} High-level output voltage	V _{ID} = 100 mV, R _L = 10 kΩ	25°C	3.2	3.8		8	8.5		V
		-55°C	3	3.8		7.8	8.5		
		125°C	3	3.8		7.8	8.4		
V _{OL} Low-level output voltage	V _{ID} = -100 mV, I _{OL} = 0	25°C	0		50	0		50	mV
		-55°C	0		50	0		50	
		125°C	0		50	0		50	
A _{VD} Large-signal differential voltage amplification	R _L = 10 kΩ, See Note 6	25°C	5	23		10	36		V/mV
		-55°C	3.5	35		7	50		
		125°C	3.5	16		7	27		
CMRR Common-mode rejection ratio	V _{IC} = V _{ICRmin}	25°C	65	80		65	85		dB
		-55°C	60	81		60	87		
		125°C	60	84		60	86		
k _{SVR} Supply-voltage rejection ratio (ΔV _{DD} /ΔV _{IO})	V _O = 1.4 V	25°C	65	95		65	95		dB
		-55°C	60	90		60	90		
		125°C	60	97		60	97		
I _{I(SEL)} Input current (BIAS SELECT)	V _{I(SEL)} = 0	25°C	-1.4			-1.9			μA
I _{DD} Supply current	V _O = V _{DD} /2, V _{IC} = V _{DD} /2, No load	25°C	675		1600	950		2000	μA
		-55°C	1000		2500	1475		3000	
		125°C	475		1100	625		1400	

† Full range is -55°C to 125°C.

NOTES: 4. The typical values of input bias current and input offset current below 5 pA were determined mathematically.

5. This range also applies to each input individually.

6. At V_{DD} = 5 V, V_O = 0.25 V to 2 V; at V_{DD} = 10 V, V_O = 1 V to 6 V.



TLC271, TLC271A, TLC271B
LinCMOS™ PROGRAMMABLE LOW-POWER
OPERATIONAL AMPLIFIERS

SLOS090A – NOVEMBER 1987 – REVISED AUGUST 1994

HIGH-BIAS MODE

operating characteristics at specified free-air temperature, $V_{DD} = 5\text{ V}$

PARAMETER	TEST CONDITIONS		T_A	TLC271C, TLC271AC, TLC271BC			UNIT
				MIN	TYP	MAX	
SR Slew rate at unity gain	$R_L = 10\text{ k}\Omega$, $C_L = 20\text{ pF}$, See Figure 98	$V_I(PP) = 1\text{ V}$	25°C	3.6		V/ μ s	
			0°C	4			
			70°C	3			
		$V_I(PP) = 2.5\text{ V}$	25°C	2.9			
			0°C	3.1			
			70°C	2.5			
V_n Equivalent input noise voltage	$f = 1\text{ kHz}$, See Figure 99	$R_S = 20\ \Omega$	25°C	25		nV/ $\sqrt{\text{Hz}}$	
B _{OM} Maximum output-swing bandwidth	$V_O = V_{OH}$, $R_L = 10\text{ k}\Omega$	$C_L = 20\text{ pF}$, See Figure 98	25°C	320		kHz	
			0°C	340			
			70°C	260			
B ₁ Unity-gain bandwidth	$V_I = 10\text{ mV}$, See Figure 100	$C_L = 20\text{ pF}$	25°C	1.7		MHz	
			0°C	2			
			70°C	1.3			
ϕ_m Phase margin	$V_I = 10\text{ mV}$, $C_L = 20\text{ pF}$	$f = B_1$, See Figure 100	25°C	46°			
			0°C	47°			
			70°C	44°			

operating characteristics at specified free-air temperature, $V_{DD} = 10\text{ V}$

PARAMETER	TEST CONDITIONS		T_A	TLC271C, TLC271AC, TLC271BC			UNIT
				MIN	TYP	MAX	
SR Slew rate at unity gain	$R_L = 10\text{ k}\Omega$, $C_L = 20\text{ pF}$, See Figure 98	$V_I(PP) = 1\text{ V}$	25°C	5.3		V/ μ s	
			0°C	5.9			
			70°C	4.3			
		$V_I(PP) = 5.5\text{ V}$	25°C	4.6			
			0°C	5.1			
			70°C	3.8			
V_n Equivalent input noise voltage	$f = 1\text{ kHz}$, See Figure 99	$R_S = 20\ \Omega$	25°C	25		nV/ $\sqrt{\text{Hz}}$	
B _{OM} Maximum output-swing bandwidth	$V_O = V_{OH}$, $R_L = 10\text{ k}\Omega$	$C_L = 20\text{ pF}$, See Figure 98	25°C	200		kHz	
			0°C	220			
			70°C	140			
B ₁ Unity-gain bandwidth	$V_I = 10\text{ mV}$, See Figure 100	$C_L = 20\text{ pF}$	25°C	2.2		MHz	
			0°C	2.5			
			70°C	1.8			
ϕ_m Phase margin	$f = B_1$, $C_L = 20\text{ pF}$	$V_I = 10\text{ mV}$, See Figure 100	25°C	49°			
			0°C	50°			
			70°C	46°			



POST OFFICE BOX 655303 • DALLAS, TEXAS 75265

8961724 0093161 913

TLC271, TLC271A, TLC271B
LinCMOS™ PROGRAMMABLE LOW-POWER
OPERATIONAL AMPLIFIERS

SLOS090A – NOVEMBER 1987 – REVISED AUGUST 1994

HIGH-BIAS MODE

operating characteristics at specified free-air temperature, $V_{DD} = 5\text{ V}$

PARAMETER	TEST CONDITIONS		T_A	TLC271I, TLC271AI, TLC271BI			UNIT
				MIN	TYP	MAX	
SR Slew rate at unity gain	$R_L = 10\text{ k}\Omega$, $C_L = 20\text{ pF}$, See Figure 98	$V_{I(PP)} = 1\text{ V}$	25°C	3.6		V/ μ s	
			-40°C	4.5			
			85°C	2.8			
		$V_{I(PP)} = 2.5\text{ V}$	25°C	2.9			
			-40°C	3.5			
			85°C	2.3			
V_n Equivalent input noise voltage	$f = 1\text{ kHz}$, See Figure 99	$R_S = 20\ \Omega$	25°C	25		nV/ $\sqrt{\text{Hz}}$	
B_{OM} Maximum output-swing bandwidth	$V_O = V_{OH}$, $R_L = 10\text{ k}\Omega$,	$C_L = 20\text{ pF}$, See Figure 98	25°C	320		kHz	
			-40°C	380			
			85°C	250			
B_1 Unity-gain bandwidth	$V_I = 10\text{ mV}$, See Figure 100	$C_L = 20\text{ pF}$,	25°C	1.7		MHz	
			-40°C	2.6			
			85°C	1.2			
ϕ_m Phase margin	$V_I = 10\text{ mV}$, $C_L = 20\text{ pF}$,	$f = B_1$, See Figure 100	25°C	46°			
			-40°C	49°			
			85°C	43°			

operating characteristics at specified free-air temperature, $V_{DD} = 10\text{ V}$

PARAMETER	TEST CONDITIONS		T_A	TLC271I, TLC271AI, TLC271BI			UNIT
				MIN	TYP	MAX	
SR Slew rate at unity gain	$R_L = 10\text{ k}\Omega$, $C_L = 20\text{ pF}$, See Figure 98	$V_{I(PP)} = 1\text{ V}$	25°C	5.3		V/ μ s	
			-40°C	6.8			
			85°C	4			
		$V_{I(PP)} = 5.5\text{ V}$	25°C	4.6			
			-40°C	5.8			
			85°C	3.5			
V_n Equivalent input noise voltage	$f = 1\text{ kHz}$, See Figure 99	$R_S = 20\ \Omega$	25°C	25		nV/ $\sqrt{\text{Hz}}$	
B_{OM} Maximum output-swing bandwidth	$V_O = V_{OH}$, $R_L = 10\text{ k}\Omega$,	$C_L = 20\text{ pF}$, See Figure 98	25°C	200		kHz	
			-40°C	260			
			85°C	130			
B_1 Unity-gain bandwidth	$V_I = 10\text{ mV}$, See Figure 100	$C_L = 20\text{ pF}$,	25°C	2.2		MHz	
			-40°C	3.1			
			85°C	1.7			
ϕ_m Phase margin	$V_I = 10\text{ mV}$, $C_L = 20\text{ pF}$,	$f = B_1$, See Figure 100	25°C	49°			
			-40°C	52°			
			85°C	46°			



POST OFFICE BOX 655203 • DALLAS, TEXAS 75265

TLC271, TLC271A, TLC271B

LinCMOS™ PROGRAMMABLE LOW-POWER OPERATIONAL AMPLIFIERS

SLOS090A – NOVEMBER 1987 – REVISED AUGUST 1994

HIGH-BIAS MODE

operating characteristics at specified free-air temperature, $V_{DD} = 5\text{ V}$

PARAMETER	TEST CONDITIONS	T_A	TLC271M			UNIT
			MIN	TYP	MAX	
SR Slew rate at unity gain	$R_L = 10\text{ k}\Omega$, $C_L = 20\text{ pF}$, See Figure 98	$V_I(\text{PP}) = 1\text{ V}$	25°C	3.6		V/ μs
			-55°C	4.7		
			125°C	2.3		
		$V_I(\text{PP}) = 2.5\text{ V}$	25°C	2.9		
			-55°C	3.7		
			125°C	2		
V_n Equivalent input noise voltage	$f = 1\text{ kHz}$, See Figure 99	$R_S = 20\ \Omega$	25°C	25		nV/ $\sqrt{\text{Hz}}$
B_{OM} Maximum output-swing bandwidth	$V_O = V_{OH}$, $R_L = 10\text{ k}\Omega$	$C_L = 20\text{ pF}$, See Figure 98	25°C	320		kHz
			-55°C	400		
			125°C	230		
B_1 Unity-gain bandwidth	$V_I = 10\text{ mV}$, See Figure 100	$C_L = 20\text{ pF}$	25°C	1.7		MHz
			-55°C	2.9		
			125°C	1.1		
			ϕ_m Phase margin	$V_I = 10\text{ mV}$, $C_L = 20\text{ pF}$	$f = B_1$, See Figure 100	
			-55°C	49°		
			125°C	41°		

operating characteristics at specified free-air temperature, $V_{DD} = 10\text{ V}$

PARAMETER	TEST CONDITIONS	T_A	TLC271M			UNIT
			MIN	TYP	MAX	
SR Slew rate at unity gain	$R_L = 10\text{ k}\Omega$, $C_L = 20\text{ pF}$, See Figure 98	$V_I(\text{PP}) = 1\text{ V}$	25°C	5.3		V/ μs
			-55°C	7.1		
			125°C	3.1		
		$V_I(\text{PP}) = 5.5\text{ V}$	25°C	4.6		
			-55°C	6.1		
			125°C	2.7		
V_n Equivalent input noise voltage	$f = 1\text{ kHz}$, See Figure 99	$R_S = 20\ \Omega$	25°C	25		nV/ $\sqrt{\text{Hz}}$
B_{OM} Maximum output-swing bandwidth	$V_O = V_{OH}$, $R_L = 10\text{ k}\Omega$	$C_L = 20\text{ pF}$, See Figure 98	25°C	200		kHz
			-55°C	280		
			125°C	110		
B_1 Unity-gain bandwidth	$V_I = 10\text{ mV}$, See Figure 100	$C_L = 20\text{ pF}$	25°C	2.2		MHz
			-55°C	3.4		
			125°C	1.6		
ϕ_m Phase margin	$f = B_1$, $C_L = 20\text{ pF}$	$V_I = 10\text{ mV}$, See Figure 100	25°C	49°		
			-55°C	52°		
			125°C	44°		



POST OFFICE BOX 655303 • DALLAS, TEXAS 75265

8961724 0093163 796

TLC271, TLC271A, TLC271B
LinCMOS™ PROGRAMMABLE LOW-POWER
OPERATIONAL AMPLIFIERS

SLOS090A – NOVEMBER 1987 – REVISED AUGUST 1994

TYPICAL CHARACTERISTICS (HIGH-BIAS MODE)

Table of Graphs

			FIGURE
V_{IO}	Input offset voltage	Distribution	2, 3
αV_{IO}	Temperature coefficient	Distribution	4, 5
V_{OH}	High-level output voltage	vs High-level output current	6, 7
		vs Supply voltage	8
		vs Free-air temperature	9
V_{OL}	Low-level output voltage	vs Common-mode input voltage	10, 11
		vs Differential input voltage	12
		vs Free-air temperature	13
		vs Low-level output current	14, 15
A_{VD}	Large-signal differential voltage amplification	vs Supply voltage	16
		vs Free-air temperature	17
		vs Frequency	28, 29
I_{IB}	Input bias current	vs Free-air temperature	18
I_{IO}	Input offset current	vs Free-air temperature	18
V_{IC}	Common-mode input voltage	vs Supply voltage	19
I_{DD}	Supply current	vs Supply voltage	20
		vs Free-air temperature	21
SR	Slew rate	vs Supply voltage	22
		vs Free-air temperature	23
	Bias-select current	vs Supply voltage	24
$V_{O(PP)}$	Maximum peak-to-peak output voltage	vs Frequency	25
B_1	Unity-gain bandwidth	vs Free-air temperature	26
		vs Supply voltage	27
A_{VD}	Large-signal differential voltage amplification	vs Frequency	28, 29
ϕ_m	Phase margin	vs Supply voltage	30
		vs Free-air temperature	31
		vs Load capacitance	32
V_n	Equivalent input noise voltage	vs Frequency	33
		Phase shift	28, 29

TYPICAL CHARACTERISTICS (HIGH-BIAS MODE)†

**DISTRIBUTION OF TLC271
 INPUT OFFSET VOLTAGE**

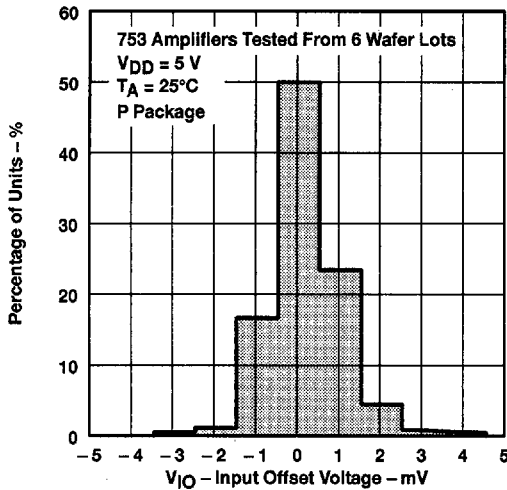

Figure 2

**DISTRIBUTION OF TLC271
 INPUT OFFSET VOLTAGE**

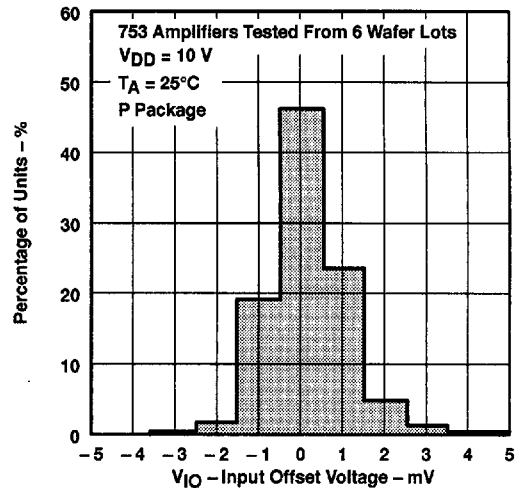

Figure 3

**DISTRIBUTION OF TLC271
 INPUT OFFSET VOLTAGE
 TEMPERATURE COEFFICIENT**

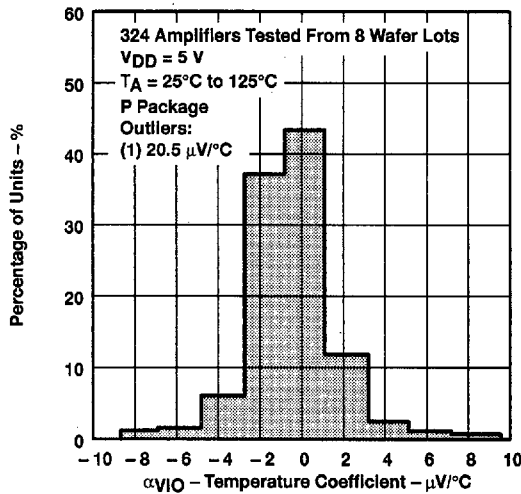

Figure 4

**DISTRIBUTION OF TLC271
 INPUT OFFSET VOLTAGE
 TEMPERATURE COEFFICIENT**

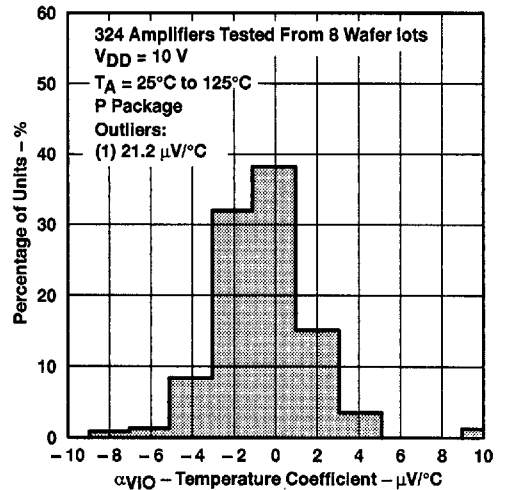

Figure 5

† Data at high and low temperatures are applicable only within the rated operating free-air temperature ranges of the various devices.

TLC271, TLC271A, TLC271B
LinCMOS™ PROGRAMMABLE LOW-POWER
OPERATIONAL AMPLIFIERS

SLOS090A – NOVEMBER 1987 – REVISED AUGUST 1994

TYPICAL CHARACTERISTICS (HIGH-BIAS MODE)†

**HIGH-LEVEL OUTPUT VOLTAGE
 vs
 HIGH-LEVEL OUTPUT CURRENT**

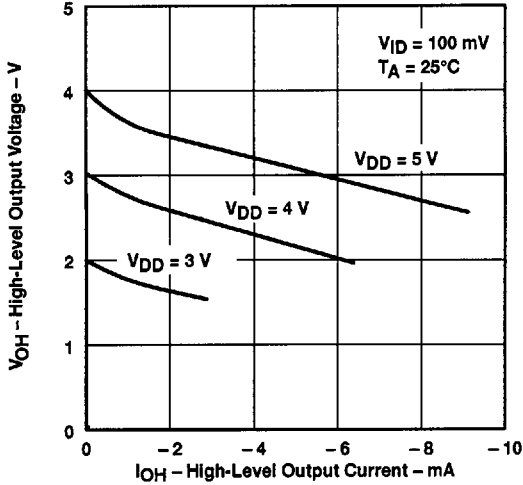

Figure 6

**HIGH-LEVEL OUTPUT VOLTAGE
 vs
 HIGH-LEVEL OUTPUT CURRENT**

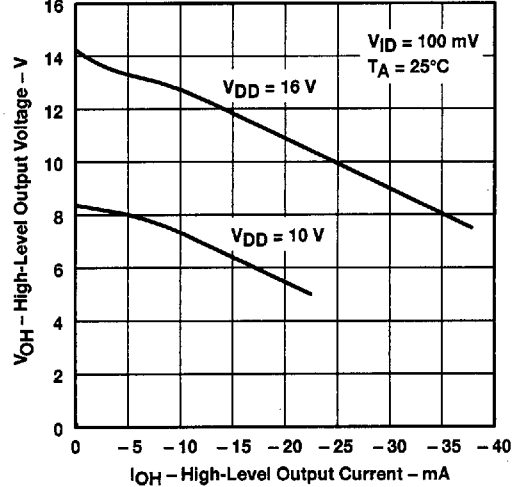

Figure 7

**HIGH-LEVEL OUTPUT VOLTAGE
 vs
 SUPPLY VOLTAGE**

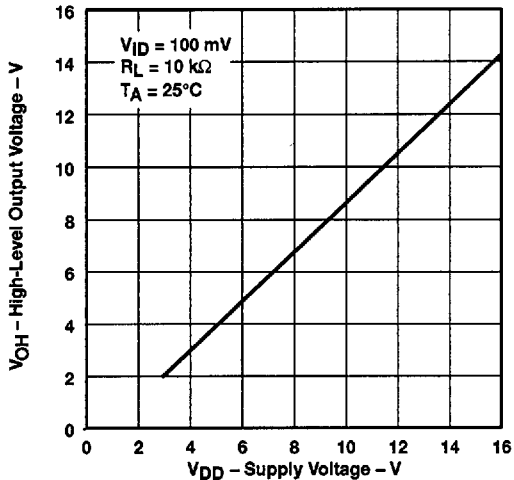

Figure 8

**HIGH-LEVEL OUTPUT VOLTAGE
 vs
 FREE-AIR TEMPERATURE**

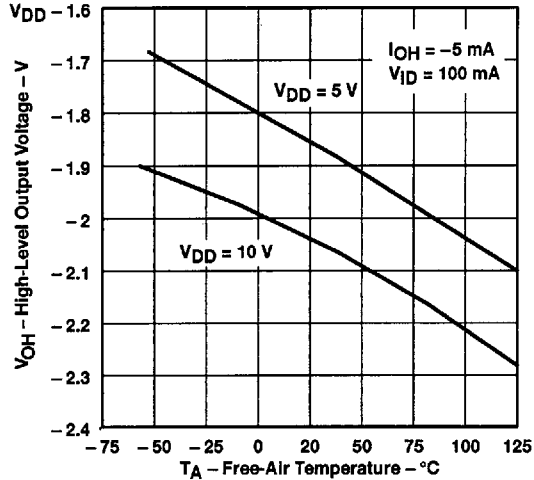

Figure 9

† Data at high and low temperatures are applicable only within the rated operating free-air temperature ranges of the various devices.

TYPICAL CHARACTERISTICS (HIGH-BIAS MODE)†

LOW-LEVEL OUTPUT VOLTAGE
 vs
 COMMON-MODE INPUT VOLTAGE

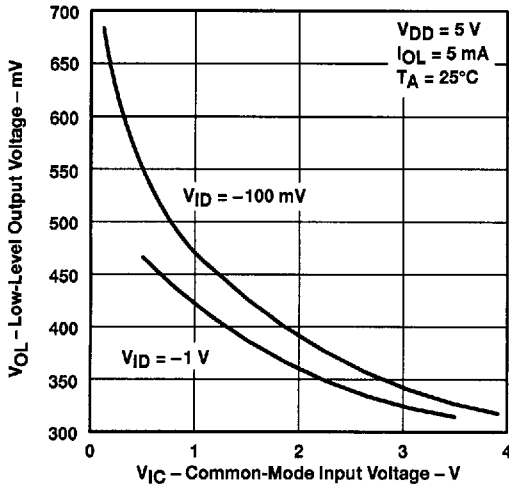

Figure 10

LOW-LEVEL OUTPUT VOLTAGE
 vs
 COMMON-MODE INPUT VOLTAGE

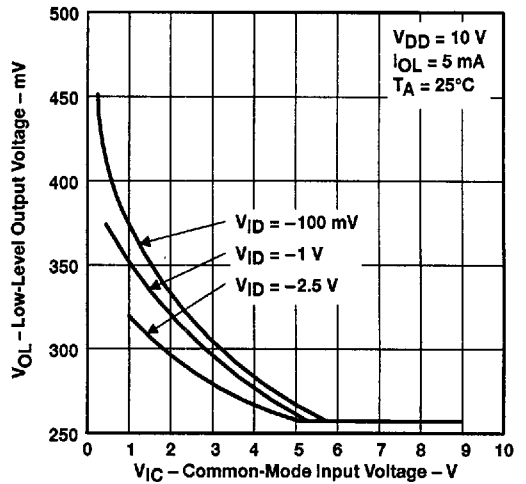

Figure 11

LOW-LEVEL OUTPUT VOLTAGE
 vs
 DIFFERENTIAL INPUT VOLTAGE

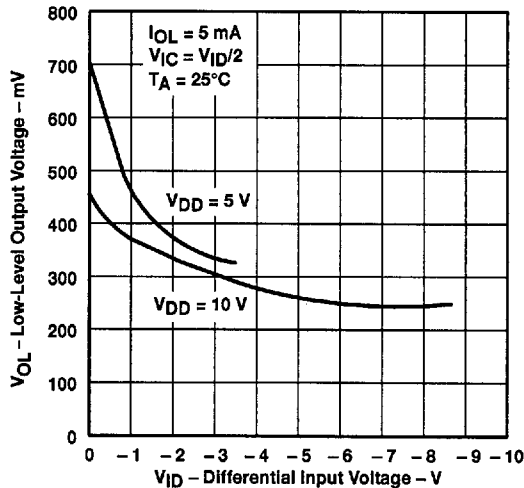

Figure 12

LOW-LEVEL OUTPUT VOLTAGE
 vs
 FREE-AIR TEMPERATURE

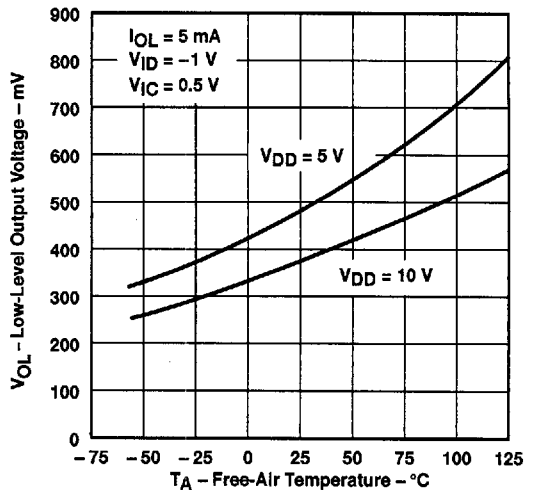

Figure 13

† Data at high and low temperatures are applicable only within the rated operating free-air temperature ranges of the various devices.

TLC271, TLC271A, TLC271B
LinCMOS™ PROGRAMMABLE LOW-POWER
OPERATIONAL AMPLIFIERS

SLOS090A - NOVEMBER 1987 - REVISED AUGUST 1994

TYPICAL CHARACTERISTICS (HIGH-BIAS MODE)†

**LOW-LEVEL OUTPUT VOLTAGE
 vs
 LOW-LEVEL OUTPUT CURRENT**

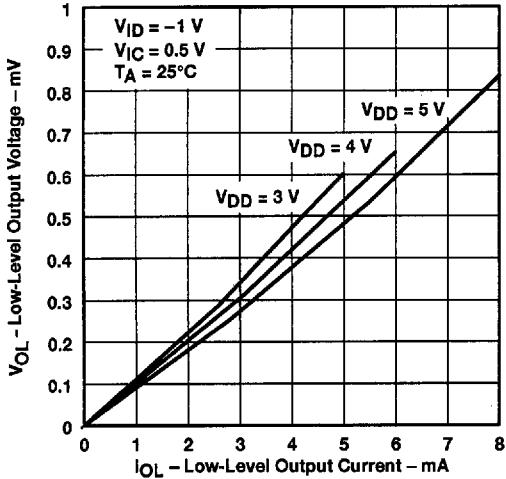

Figure 14

**LOW-LEVEL OUTPUT VOLTAGE
 vs
 LOW-LEVEL OUTPUT CURRENT**

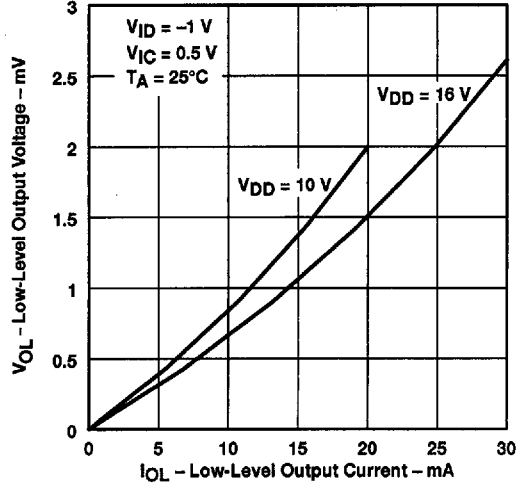

Figure 15

**LARGE-SIGNAL
 DIFFERENTIAL VOLTAGE AMPLIFICATION
 vs
 SUPPLY VOLTAGE**

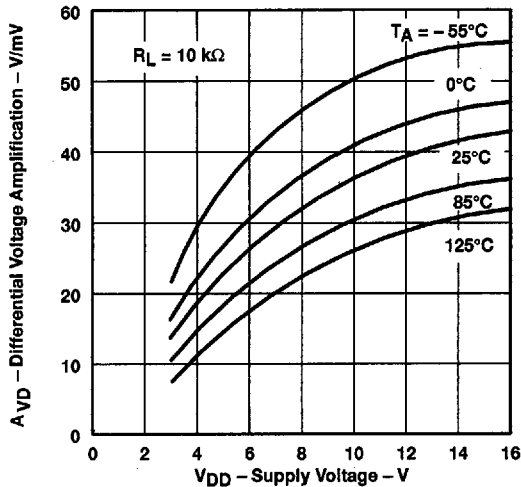

Figure 16

**LARGE-SIGNAL
 DIFFERENTIAL VOLTAGE AMPLIFICATION
 vs
 FREE-AIR TEMPERATURE**

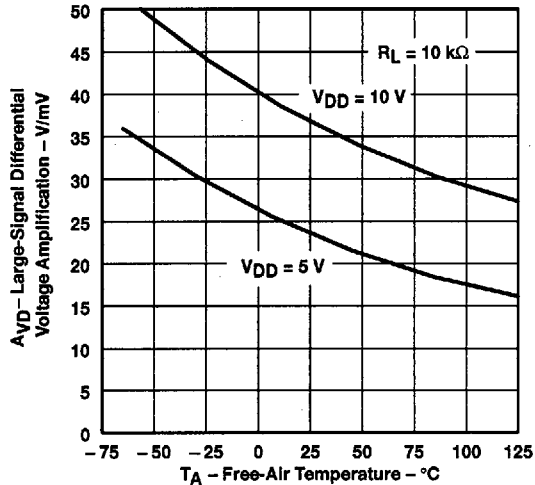
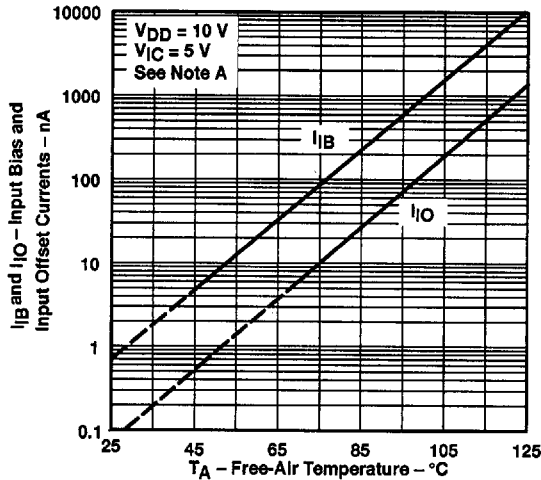

Figure 17

† Data at high and low temperatures are applicable only within the rated operating free-air temperature ranges of the various devices.

TYPICAL CHARACTERISTICS (HIGH-BIAS MODE)†

INPUT BIAS CURRENT AND INPUT OFFSET CURRENT
 vs
 FREE-AIR TEMPERATURE



NOTE A: The typical values of input bias current and input offset current below 5 pA were determined mathematically.

Figure 18

COMMON-MODE INPUT VOLTAGE
 (POSITIVE LIMIT)
 vs
 SUPPLY VOLTAGE

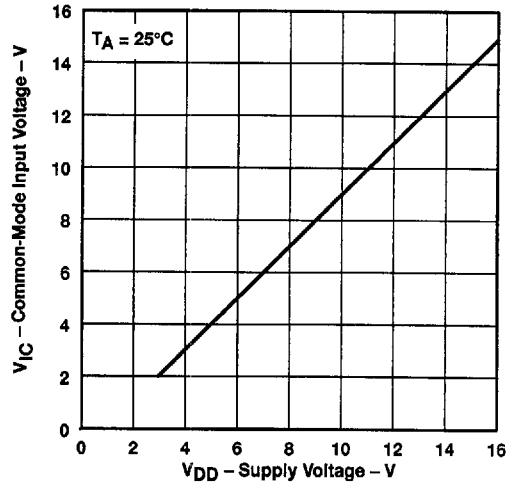

Figure 19

SUPPLY CURRENT
 vs
 SUPPLY VOLTAGE

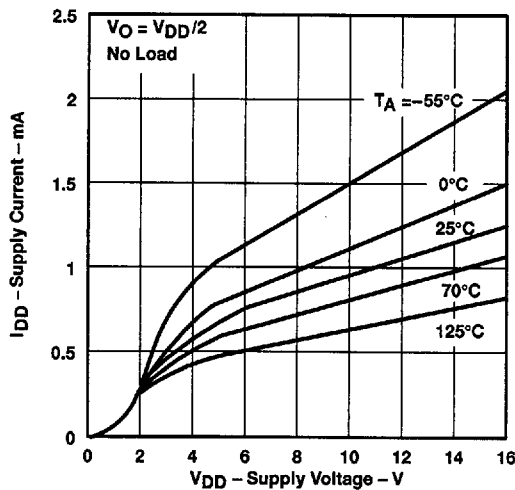

Figure 20

SUPPLY CURRENT
 vs
 FREE-AIR TEMPERATURE

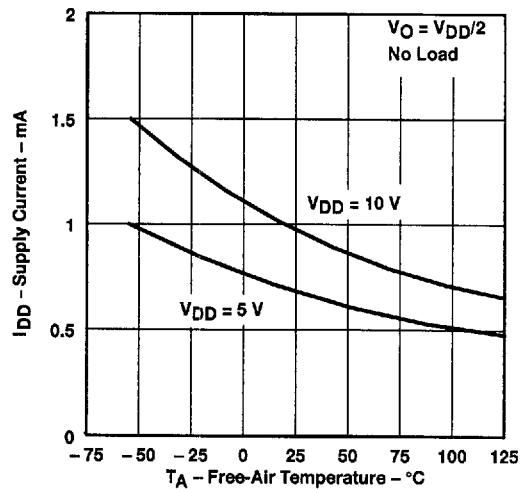

Figure 21

† Data at high and low temperatures are applicable only within the rated operating free-air temperature ranges of the various devices.

TLC271, TLC271A, TLC271B
LinCMOS™ PROGRAMMABLE LOW-POWER
OPERATIONAL AMPLIFIERS

SLOS090A - NOVEMBER 1987 - REVISED AUGUST 1994

TYPICAL CHARACTERISTICS (HIGH-BIAS MODE)†

SLEW RATE
vs
SUPPLY VOLTAGE

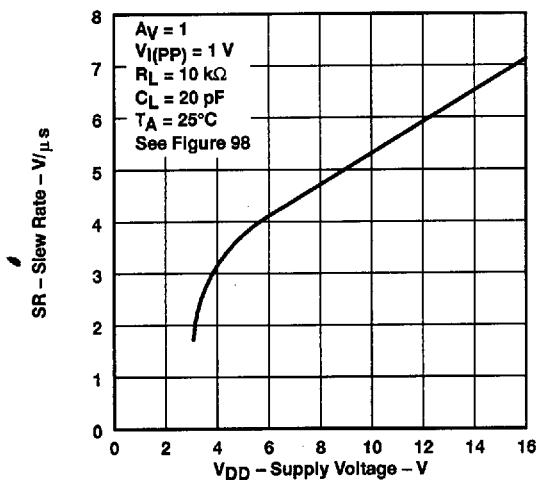

Figure 22

SLEW RATE
vs
FREE-AIR TEMPERATURE

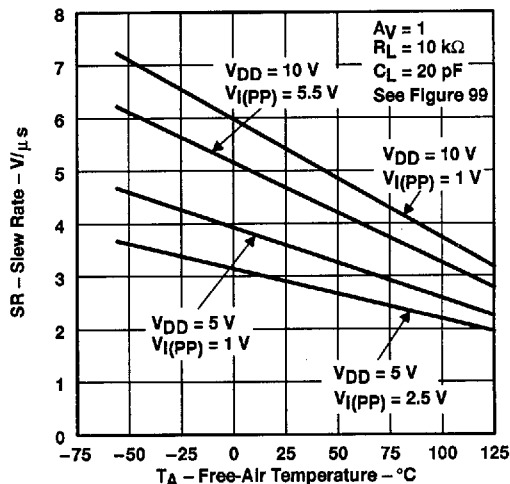

Figure 23

BIAS-SELECT CURRENT
vs
SUPPLY VOLTAGE

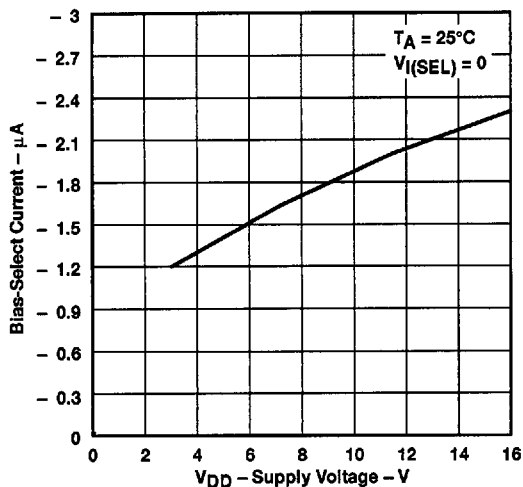

Figure 24

MAXIMUM PEAK-TO-PEAK OUTPUT
VOLTAGE
vs
FREQUENCY

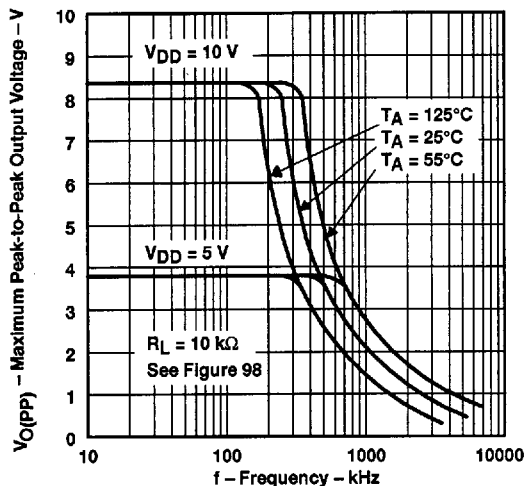

Figure 25

† Data at high and low temperatures are applicable only within the rated operating free-air temperature ranges of the various devices.

TYPICAL CHARACTERISTICS (HIGH-BIAS MODE)†

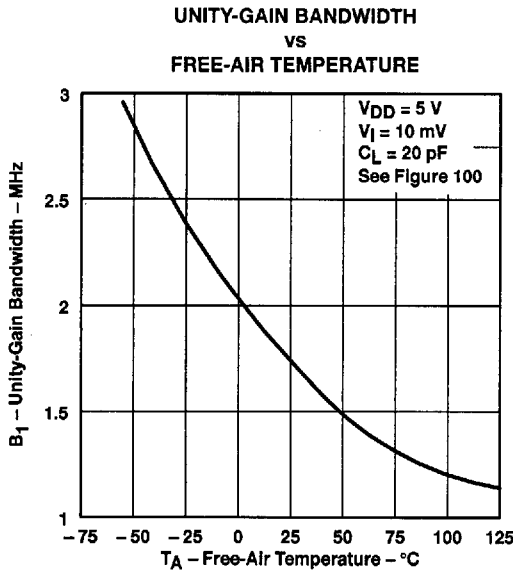

Figure 26

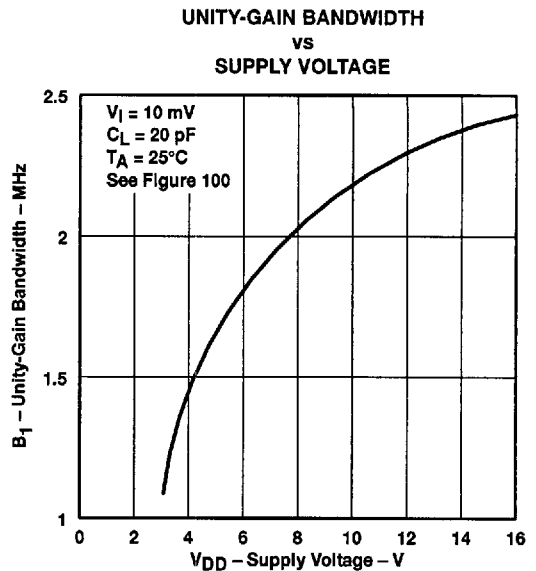

Figure 27

LARGE-SIGNAL DIFFERENTIAL VOLTAGE
 AMPLIFICATION AND PHASE SHIFT
 VS
 FREQUENCY

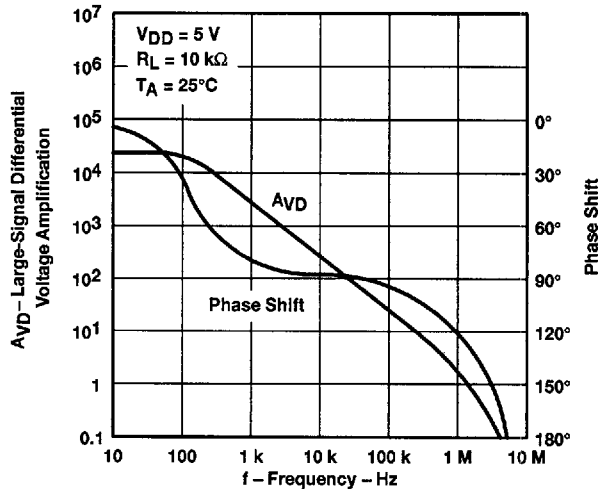

Figure 28

† Data at high and low temperatures are applicable only within the rated operating free-air temperature ranges of the various devices.

TLC271, TLC271A, TLC271B
LinCMOS™ PROGRAMMABLE LOW-POWER
OPERATIONAL AMPLIFIERS

SLOS090A – NOVEMBER 1987 – REVISED AUGUST 1994

TYPICAL CHARACTERISTICS (HIGH-BIAS MODE)†

LARGE-SCALE DIFFERENTIAL VOLTAGE
AMPLIFICATION AND PHASE SHIFT

vs
FREQUENCY

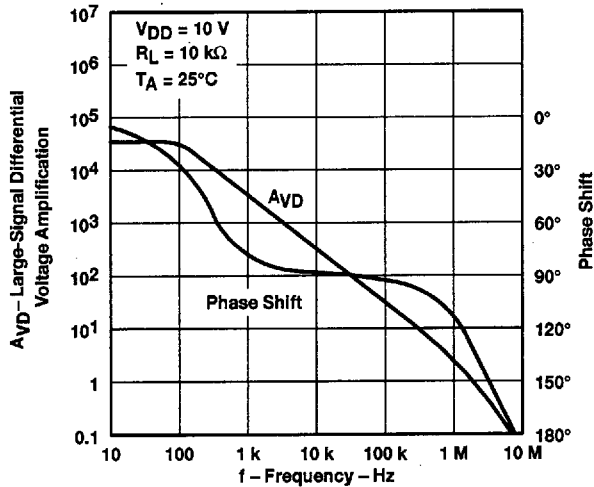

Figure 29

PHASE MARGIN
vs
SUPPLY VOLTAGE

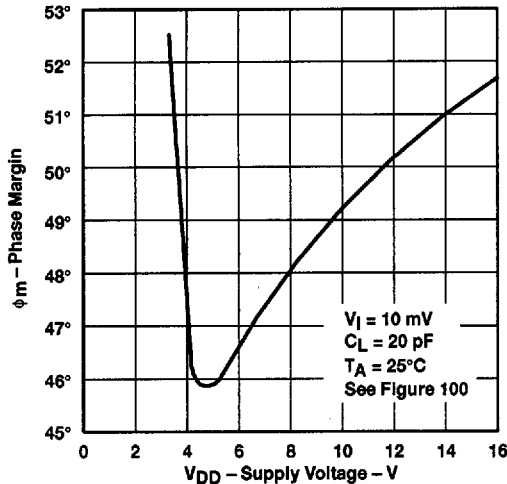

Figure 30

PHASE MARGIN
vs
FREE-AIR TEMPERATURE

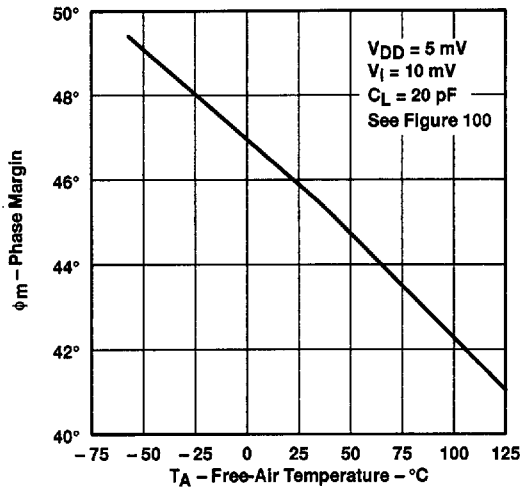

Figure 31

† Data at high and low temperatures are applicable only within the rated operating free-air temperature ranges of the various devices.

TYPICAL CHARACTERISTICS (HIGH-BIAS MODE)†

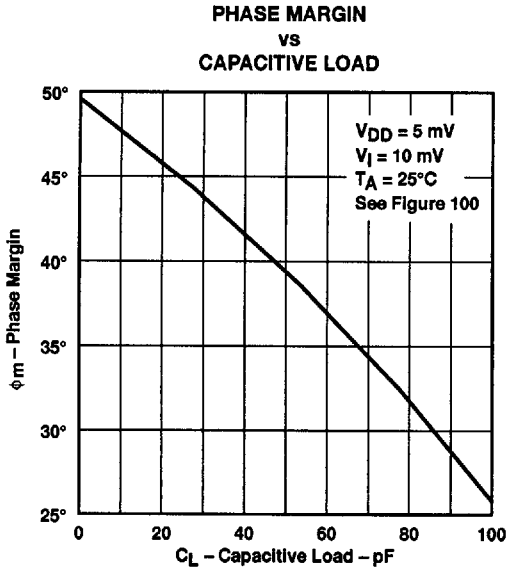

Figure 32

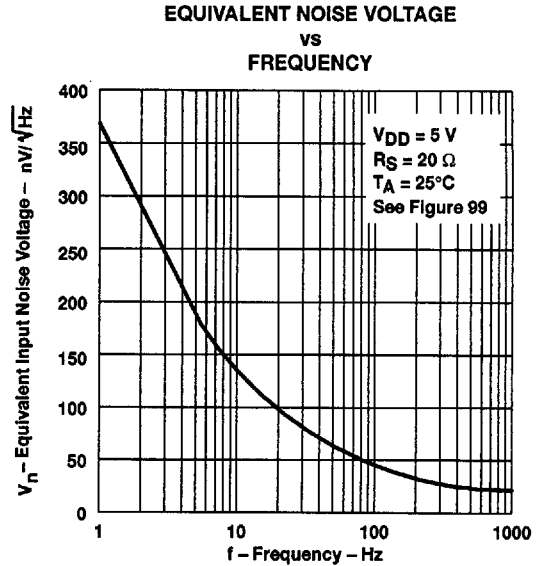

Figure 33

† Data at high and low temperatures are applicable only within the rated operating free-air temperature ranges of the various devices.

TLC271, TLC271A, TLC271B
LinCMOS™ PROGRAMMABLE LOW-POWER
OPERATIONAL AMPLIFIERS

SLOS090A - NOVEMBER 1987 - REVISED AUGUST 1994

MEDIUM-BIAS MODE

electrical characteristics at specified free-air temperature (unless otherwise noted)

PARAMETER		TEST CONDITIONS	T _A †	TLC271C, TLC271AC, TLC271BC						UNIT
				V _{DD} = 5 V			V _{DD} = 10 V			
				MIN	TYP	MAX	MIN	TYP	MAX	
V _{IO}	Input offset voltage	TLC271C V _O = 1.4 V, V _{IC} = 0 R _S = 50 Ω, R _I = 100 kΩ	25°C		1.1	10		1.1	10	mV
			Full range			12		12		
			25°C		0.9	5		0.9	5	
			Full range			6.5		6.5		
			25°C		0.25	2		0.26	2	
			Full range			3		3		
α _{VIO}	Average temperature coefficient of input offset voltage		25°C to 70°C		1.7		2.1		μV/°C	
I _{IO}	Input offset current (see Note 4)	V _O = V _{DD} /2, V _{IC} = V _{DD} /2	25°C		0.1			0.1	pA	
			70°C		7	300		7		300
I _{IB}	Input bias current (see Note 4)	V _O = V _{DD} /2, V _{IC} = V _{DD} /2	25°C		0.6			0.7	pA	
			70°C		40	600		50		600
V _{ICR}	Common-mode input voltage range (see Note 5)		25°C	-0.2 to 4	-0.3 to 4.2		-0.2 to 9	-0.3 to 9.2	V	
			Full range	-0.2 to 3.5			-0.2 to 8.5		V	
V _{OH}	High-level output voltage	V _{ID} = 100 mV, R _L = 100 kΩ	25°C	3.2	3.9		8	8.7	V	
			0°C	3	3.9		7.8	8.7		
			70°C	3	4		7.8	8.7		
V _{OL}	Low-level output voltage	V _{ID} = -100 mV, I _{OL} = 0	25°C		0	50		0	50	mV
			0°C		0	50		0	50	
			70°C		0	50		0	50	
A _{VD}	Large-signal differential voltage amplification	R _L = 100 kΩ, See Note 6	25°C	25	170		25	275	V/mV	
			0°C		15	200		15		320
			70°C		15	140		15		230
CMRR	Common-mode rejection ratio	V _{IC} = V _{ICRmin}	25°C	65	91		65	94	dB	
			0°C	60	91		60	94		
			70°C	60	92		60	94		
k _{SVR}	Supply-voltage rejection ratio (ΔV _{DD} /ΔV _{IO})	V _O = 1.4 V	25°C	70	93		70	93	dB	
			0°C	60	92		60	92		
			70°C	60	94		60	94		
I _{I(SEL)}	Input current (BIAS SELECT)	V _{I(SEL)} = V _{DD} /2	25°C		-130			-160	nA	
			25°C		105	280		143	300	
I _{DD}	Supply current	V _O = V _{DD} /2, V _{IC} = V _{DD} /2, No load	0°C		125	320		173	400	μA
			25°C		85	220		110	280	
			70°C							

† Full range is 0°C to 70°C.

- NOTES: 4. The typical values of input bias current and input offset current below 5 pA were determined mathematically.
5. This range also applies to each input individually.
6. At V_{DD} = 5 V, V_O = 0.25 V to 2 V; at V_{DD} = 10 V, V_O = 1 V to 6 V.

TLC271, TLC271A, TLC271B
LinCMOS™ PROGRAMMABLE LOW-POWER
OPERATIONAL AMPLIFIERS

SLOS090A – NOVEMBER 1987 – REVISED AUGUST 1994

MEDIUM-BIAS MODE

electrical characteristics at specified free-air temperature (unless otherwise noted)

PARAMETER		TEST CONDITIONS	T _A †	TLC271, TLC271A, TLC271B						UNIT
				V _{DD} = 5 V			V _{DD} = 10 V			
				MIN	TYP	MAX	MIN	TYP	MAX	
V _{IO}	Input offset voltage	TLC271 V _O = 1.4 V, V _{IC} = 0 V, R _S = 50 Ω, R _L = 100 kΩ	25°C	1.1 10			1.1 10			mV
			Full range	13			13			
			25°C	0.9 5			0.9 5			
			Full range	7			7			
			25°C	0.25 2			0.26 2			
			Full range	3.5			3.5			
αV _{IO}	Average temperature coefficient of input offset voltage		25°C to 85°C	1.7			2.1			μV/°C
I _{IO}	Input offset current (see Note 4)	V _O = V _{DD} /2, V _{IC} = V _{DD} /2	25°C	0.1			0.1			pA
			85°C	24 1000			26 1000			
I _{IB}	Input bias current (see Note 4)	V _O = V _{DD} /2, V _{IC} = V _{DD} /2	25°C	0.6			0.7			pA
			85°C	200 2000			220 2000			
V _{ICR}	Common-mode input voltage range (see Note 5)		25°C	-0.2 to 4	-0.3 to 4.2		-0.2 to 9	-0.3 to 9.2		V
			Full range	-0.2 to 3.5			-0.2 to 8.5			V
V _{OH}	High-level output voltage	V _{ID} = 100 mV, R _L = 100 kΩ	25°C	3.2	3.9		8	8.7		V
			-40°C	3	3.9		7.8	8.7		
			85°C	3	4		7.8	8.7		
V _{OL}	Low-level output voltage	V _{ID} = -100 mV, I _{OL} = 0	25°C		0 50		0	50		mV
			-40°C		0 50		0	50		
			85°C		0 50		0	50		
A _{VD}	Large-signal differential voltage amplification	R _L = 100 kΩ, See Note 6	25°C	25	170		25	275		V/mV
			-40°C	15	270		15	390		
			85°C	15	130		15	220		
CMRR	Common-mode rejection ratio	V _{IC} = V _{ICRmin}	25°C	65	91		65	94		dB
			-40°C	60	90		60	93		
			85°C	60	90		60	94		
k _{SVR}	Supply-voltage rejection ratio (ΔV _{DD} /ΔV _{IO})	V _O = 1.4 V	25°C	70	93		70	93		dB
			-40°C	60	91		60	91		
			85°C	60	94		60	94		
I _{I(SEL)}	Input current (BIAS SELECT)	V _{I(SEL)} = V _{DD} /2	25°C	-130			-160			nA
I _{DD}	Supply current	V _O = V _{DD} /2, V _{IC} = V _{DD} /2, No load	25°C	105 280			143 300			μA
			-40°C	158 400			225 450			
			85°C	80 200			103 260			

† Full range is -40°C to 85°C.

- NOTES: 4. The typical values of input bias current and input offset current below 5 pA were determined mathematically.
5. This range also applies to each input individually.
6. At V_{DD} = 5 V, V_O = 0.25 V to 2 V; at V_{DD} = 10 V, V_O = 1 V to 6 V.



POST OFFICE BOX 655303 • DALLAS, TEXAS 75265

TLC271, TLC271A, TLC271B
LinCMOS™ PROGRAMMABLE LOW-POWER
OPERATIONAL AMPLIFIERS

SLOS090A—NOVEMBER 1987—REVISED AUGUST 1994

MEDIUM-BIAS MODE

electrical characteristics at specified free-air temperature (unless otherwise noted)

PARAMETER	TEST CONDITIONS	T _A †	TLC271M						UNIT
			V _{DD} = 5 V			V _{DD} = 10 V			
			MIN	TYP	MAX	MIN	TYP	MAX	
V _{IO} Input offset voltage	V _O = 1.4 V, V _{IC} = 0 V, R _S = 50 Ω, R _L = 100 kΩ	25°C	1.1		10	1.1		10	mV
		Full range				12		12	
α _{VIO} Average temperature coefficient of input offset voltage		25°C to 125°C	1.7			2.1			μV/°C
I _{IO} Input offset current (see Note 4)	V _O = V _{DD} /2, V _{IC} = V _{DD} /2	25°C	0.1			0.1			pA
		125°C	1.4	15		1.8	15		nA
I _{IB} Input bias current (see Note 4)	V _O = V _{DD} /2, V _{IC} = V _{DD} /2	25°C	0.6			0.7			pA
		125°C	9	35		10	35		nA
V _{ICR} Common-mode input voltage range (see Note 5)		25°C	0 to 4	-0.3 to 4.2		0 to 9	-0.3 to 9.2		V
		Full range	0 to 3.5				0 to 8.5		
V _{OH} High-level output voltage	V _{ID} = 100 mV, R _L = 100 kΩ	25°C	3.2	3.9		8	8.7		V
		-55°C	3	3.9		7.8	8.6		
		125°C	3	4		7.8	8.6		
V _{OL} Low-level output voltage	V _{ID} = -100 mV, I _{OL} = 0	25°C	0			50	0		mV
		-55°C	0			50	0		
		125°C	0			50	0		
A _{VD} Large-signal differential voltage amplification	R _L = 10 kΩ See Note 6	25°C	25	170		25	275		V/mV
		-55°C	15	290		15	420		
		125°C	15	120		15	190		
CMRR Common-mode rejection ratio	V _{IC} = V _{ICRmin}	25°C	65	91		65	94		dB
		-55°C	60	89		60	93		
		125°C	60	91		60	93		
k _{SVR} Supply-voltage rejection ratio (ΔV _{DD} /ΔV _{IO})	V _O = 1.4 V	25°C	70	93		70	93		dB
		-55°C	60	91		60	91		
		125°C	60	94		60	94		
I _{I(SEL)} Input current (BIAS SELECT)	V _{I(SEL)} = V _{DD} /2	25°C	-130			-160			nA
I _{DD} Supply current	V _O = V _{DD} /2, V _{IC} = V _{DD} /2, No load	25°C	105		280	143		300	μA
		-55°C	170		440	245		500	
		125°C	70		180	90		240	

† Full range is -55°C to 125°C.

NOTES: 4. The typical values of input bias current and input offset current below 5 pA were determined mathematically.

5. This range also applies to each input individually.

6. At V_{DD} = 5 V, V_O = 0.25 V to 2 V; at V_{DD} = 10 V, V_O = 1 V to 6 V.

TLC271, TLC271A, TLC271B
LinCMOS™ PROGRAMMABLE LOW-POWER
OPERATIONAL AMPLIFIERS

SLOS090A – NOVEMBER 1987 – REVISED AUGUST 1994

MEDIUM-BIAS MODE

operating characteristics at specified free-air temperature, $V_{DD} = 5\text{ V}$

PARAMETER	TEST CONDITIONS	T_A	TLC271C, TLC271AC, TLC271BC			UNIT
			MIN	TYP	MAX	
SR Slew rate at unity gain	$R_L = 100\text{ k}\Omega$, $C_L = 20\text{ pF}$, See Figure 98	$V_{I(PP)} = 1\text{ V}$	25°C	0.43		V/ μ s
			0°C	0.46		
			70°C	0.36		
		$V_{I(PP)} = 2.5\text{ V}$	25°C	0.40		
			0°C	0.43		
			70°C	0.34		
V_n Equivalent input noise voltage	$f = 1\text{ kHz}$, See Figure 99	$R_S = 20\ \Omega$	25°C	32		nV/ $\sqrt{\text{Hz}}$
B_{OM} Maximum output-swing bandwidth	$V_O = V_{OH}$, $R_L = 100\text{ k}\Omega$	$C_L = 20\text{ pF}$, See Figure 98	25°C	55		kHz
			0°C	60		
			70°C	50		
B_1 Unity-gain bandwidth	$V_I = 10\text{ mV}$, See Figure 100	$C_L = 20\text{ pF}$	25°C	525		kHz
			0°C	600		
			70°C	400		
ϕ_m Phase margin	$V_I = 10\text{ mV}$, $C_L = 20\text{ pF}$	$f = B_1$, See Figure 100	25°C	40°		
			0°C	41°		
			70°C	39°		

operating characteristics at specified free-air temperature, $V_{DD} = 10\text{ V}$

PARAMETER	TEST CONDITIONS	T_A	TLC271C, TLC271AC, TLC271BC			UNIT
			MIN	TYP	MAX	
SR Slew rate at unity gain	$R_L = 100\text{ k}\Omega$, $C_L = 20\text{ pF}$, See Figure 98	$V_{I(PP)} = 1\text{ V}$	25°C	0.62		V/ μ s
			0°C	0.67		
			70°C	0.51		
		$V_{I(PP)} = 5.5\text{ V}$	25°C	0.56		
			0°C	0.61		
			70°C	0.46		
V_n Equivalent input noise voltage	$f = 1\text{ kHz}$, See Figure 99	$R_S = 20\ \Omega$	25°C	32		nV/ $\sqrt{\text{Hz}}$
B_{OM} Maximum output-swing bandwidth	$V_O = V_{OH}$, $R_L = 100\text{ k}\Omega$	$C_L = 20\text{ pF}$, See Figure 98	25°C	35		kHz
			0°C	40		
			70°C	30		
B_1 Unity-gain bandwidth	$V_I = 10\text{ mV}$, See Figure 100	$C_L = 20\text{ pF}$	25°C	635		kHz
			0°C	710		
			70°C	510		
ϕ_m Phase margin	$V_I = 10\text{ mV}$, $C_L = 20\text{ pF}$	$f = B_1$, See Figure 100	25°C	43°		
			0°C	44°		
			70°C	42°		



POST OFFICE BOX 655303 • DALLAS, TEXAS 75265

TLC271, TLC271A, TLC271B
LinCMOS™ PROGRAMMABLE LOW-POWER
OPERATIONAL AMPLIFIERS

SLOS090A – NOVEMBER 1987 – REVISED AUGUST 1994

MEDIUM-BIAS MODE

operating characteristics at specified free-air temperature, $V_{DD} = 5\text{ V}$

PARAMETER	TEST CONDITIONS		T_A	TLC271I, TLC271AI, TLC271BI			UNIT
				MIN	TYP	MAX	
SR Slew rate at unity gain	$R_L = 100\text{ k}\Omega$, $C_L = 20\text{ pF}$, See Figure 98	$V_I(PP) = 1\text{ V}$	25°C	0.43		V/ μ s	
			-40°C	0.51			
			85°C	0.35			
		$V_I(PP) = 2.5\text{ V}$	25°C	0.40			
			-40°C	0.48			
			85°C	0.32			
V_n Equivalent input noise voltage	$f = 1\text{ kHz}$, See Figure 99	$R_S = 20\ \Omega$	25°C	32		nV/ $\sqrt{\text{Hz}}$	
B_{OM} Maximum output-swing bandwidth	$V_O = V_{OH,3}$, $R_L = 100\text{ k}\Omega$	$C_L = 20\text{ pF}$, See Figure 98	25°C	55		kHz	
			-40°C	75			
			85°C	45			
B_1 Unity-gain bandwidth	$V_I = 10\text{ mV}$, See Figure 100	$C_L = 20\text{ pF}$	25°C	525		MHz	
			-40°C	770			
			85°C	370			
ϕ_m Phase margin	$V_I = 10\text{ mV}$, $C_L = 20\text{ pF}$	$f = B_1$, See Figure 100	25°C	40°			
			-40°C	43°			
			85°C	38°			

operating characteristics at specified free-air temperature, $V_{DD} = 10\text{ V}$

PARAMETER	TEST CONDITIONS		T_A	TLC271I, TLC271AI, TLC271BI			UNIT
				MIN	TYP	MAX	
SR Slew rate at unity gain	$R_L = 100\text{ k}\Omega$, $C_L = 20\text{ pF}$, See Figure 98	$V_I(PP) = 1\text{ V}$	25°C	0.62		V/ μ s	
			-40°C	0.77			
			85°C	0.47			
		$V_I(PP) = 5.5\text{ V}$	25°C	0.56			
			-40°C	0.70			
			85°C	0.44			
V_n Equivalent input noise voltage	$f = 1\text{ kHz}$, See Figure 99	$R_S = 20\ \Omega$	25°C	32		nV/ $\sqrt{\text{Hz}}$	
B_{OM} Maximum output-swing bandwidth	$V_O = V_{OH,3}$, $R_L = 100\text{ k}\Omega$	$C_L = 20\text{ pF}$, See Figure 98	25°C	35		kHz	
			-40°C	45			
			85°C	25			
B_1 Unity-gain bandwidth	$V_I = 10\text{ mV}$, See Figure 100	$C_L = 20\text{ pF}$	25°C	635		kHz	
			-40°C	880			
			85°C	480			
ϕ_m Phase margin	$V_I = 10\text{ mV}$, $C_L = 20\text{ pF}$	$f = B_1$, See Figure 100	25°C	43°			
			-40°C	46°			
			85°C	41°			

8961724 0093178 117



TLC271, TLC271A, TLC271B
LinCMOS™ PROGRAMMABLE LOW-POWER
OPERATIONAL AMPLIFIERS

SLOS090A – NOVEMBER 1987 – REVISED AUGUST 1994

MEDIUM-BIAS MODE

operating characteristics at specified free-air temperature, $V_{DD} = 5\text{ V}$

PARAMETER	TEST CONDITIONS	T _A	TLC271M			UNIT
			MIN	TYP	MAX	
SR Slew rate at unity gain	R _L = 100 kΩ, C _L = 20 pF, See Figure 98	V _{I(PP)} = 1 V	25°C	0.43		V/μs
			-55°C	0.54		
			125°C	0.29		
		V _{I(PP)} = 2.5 V	25°C	0.40		
			-55°C	0.50		
			125°C	0.28		
V _n Equivalent input noise voltage	f = 1 kHz, See Figure 99 R _S = 20 Ω	25°C	32		nV/√Hz	
B _{OM} Maximum output-swing bandwidth	V _O = V _{OH} , R _L = 100 kΩ, C _L = 20 pF, See Figure 98	25°C	55		kHz	
		-55°C	80			
		125°C	40			
B ₁ Unity-gain bandwidth	V _I = 10 mV, See Figure 100 C _L = 20 pF,	25°C	525		kHz	
		-55°C	850			
		125°C	330			
φ _m Phase margin	V _I = 10 mV, C _L = 20 pF, f = B ₁ , See Figure 100	25°C	40°			
		-55°C	43°			
		125°C	36°			

operating characteristics at specified free-air temperature, $V_{DD} = 10\text{ V}$

PARAMETER	TEST CONDITIONS	T _A	TLC271M			UNIT
			MIN	TYP	MAX	
SR Slew rate at unity gain	R _L = 100 kΩ, C _L = 20 pF, See Figure 98	V _{I(PP)} = 1 V	25°C	0.62		V/μs
			-55°C	0.81		
			125°C	0.38		
		V _{I(PP)} = 5.5 V	25°C	0.56		
			-55°C	0.73		
			125°C	0.35		
V _n Equivalent input noise voltage	f = 1 kHz, See Figure 99 R _S = 20 Ω	25°C	32		nV/√Hz	
B _{OM} Maximum output-swing bandwidth	V _O = V _{OH} , R _L = 100 kΩ, C _L = 20 pF, See Figure 98	25°C	35		kHz	
		-55°C	50			
		125°C	20			
B ₁ Unity-gain bandwidth	V _I = 10 mV, See Figure 100 C _L = 20 pF,	25°C	635		kHz	
		-55°C	960			
		125°C	440			
φ _m Phase margin	V _I = 10 mV, C _L = 20 pF, f = B ₁ , See Figure 100	25°C	43°			
		-55°C	47°			
		125°C	39°			



POST OFFICE BOX 655303 • DALLAS, TEXAS 75265

2-495

TLC271, TLC271A, TLC271B
LinCMOS™ PROGRAMMABLE LOW-POWER
OPERATIONAL AMPLIFIERS

SLOS090A – NOVEMBER 1987 – REVISED AUGUST 1994

TYPICAL CHARACTERISTICS (MEDIUM-BIAS MODE)

Table of Graphs

			FIGURE
V_{IO}	Input offset voltage	Distribution	34, 35
α_{IO}	Temperature coefficient	Distribution	36, 37
V_{OH}	High-level output voltage	vs High-level output current	38, 39
		vs Supply voltage	40
		vs Free-air temperature	41
V_{OL}	Low-level output voltage	vs Common-mode input voltage	42, 43
		vs Differential input voltage	44
		vs Free-air temperature	45
		vs Low-level output current	46, 47
A_{VD}	Large-signal differential voltage amplification	vs Supply voltage	48
		vs Free-air temperature	49
		vs Frequency	60, 61
I_{IB}	Input bias current	vs Free-air temperature	50
I_{IO}	Input offset current	vs Free-air temperature	50
V_I	Maximum input voltage	vs Supply voltage	51
I_{DD}	Supply current	vs Supply voltage	52
		vs Free-air temperature	53
SR	Slew rate	vs Supply voltage	54
		vs Free-air temperature	55
	Bias-select current	vs Supply voltage	56
$V_{O(PP)}$	Maximum peak-to-peak output voltage	vs Frequency	57
B_1	Unity-gain bandwidth	vs Free-air temperature	58
		vs Supply voltage	59
ϕ_m	Phase margin	vs Supply voltage	62
		vs Free-air temperature	63
		vs Load capacitance	64
V_n	Equivalent input noise voltage	vs Frequency	65
		Phase shift	60, 61



POST OFFICE BOX 655303 • DALLAS, TEXAS 75265

TYPICAL CHARACTERISTICS (MEDIUM-BIAS MODE)†

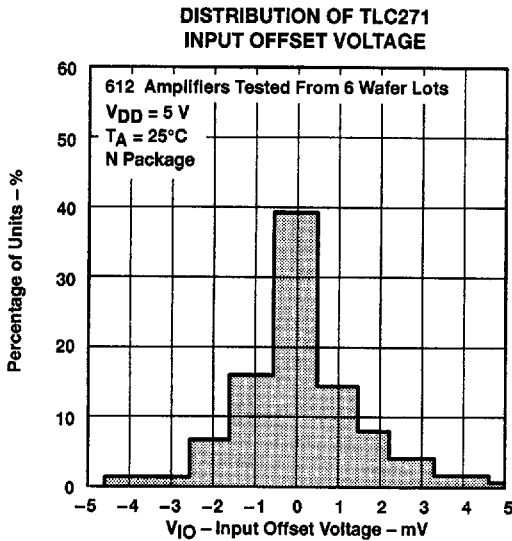

Figure 34

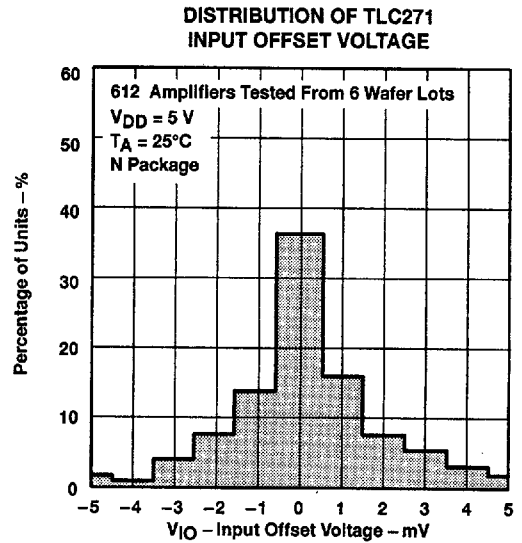

Figure 35

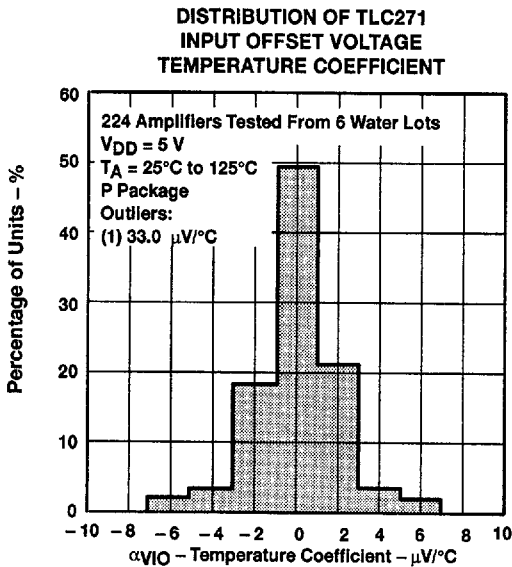

Figure 36

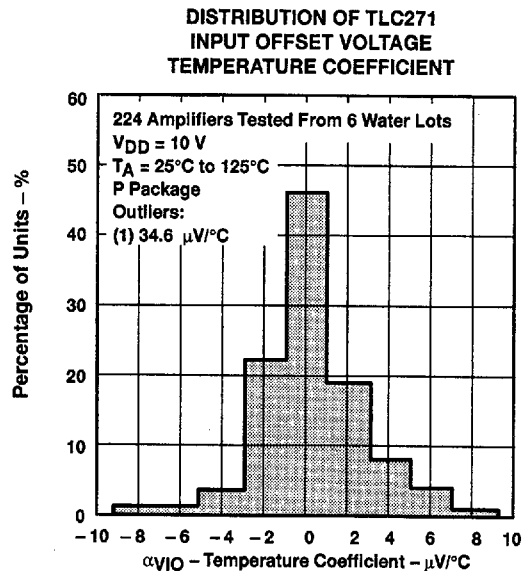

Figure 37

† Data at high and low temperatures are applicable only within the rated operating free-air temperature ranges of the various devices.

TLC271, TLC271A, TLC271B
LinCMOS™ PROGRAMMABLE LOW-POWER
OPERATIONAL AMPLIFIERS

SLOS090A - NOVEMBER 1987 - REVISED AUGUST 1994

TYPICAL CHARACTERISTICS (MEDIUM-BIAS MODE)†

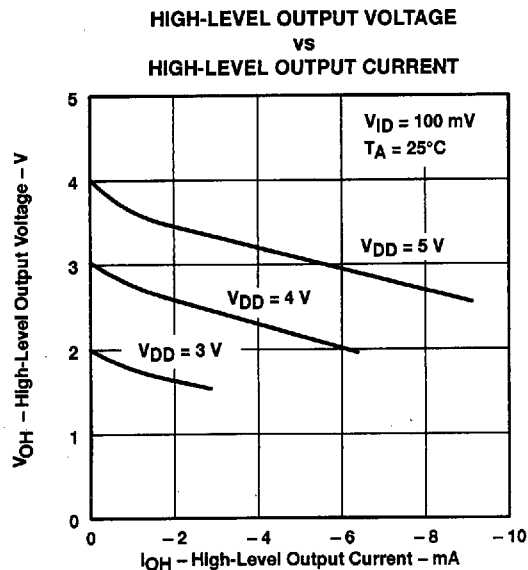

Figure 38

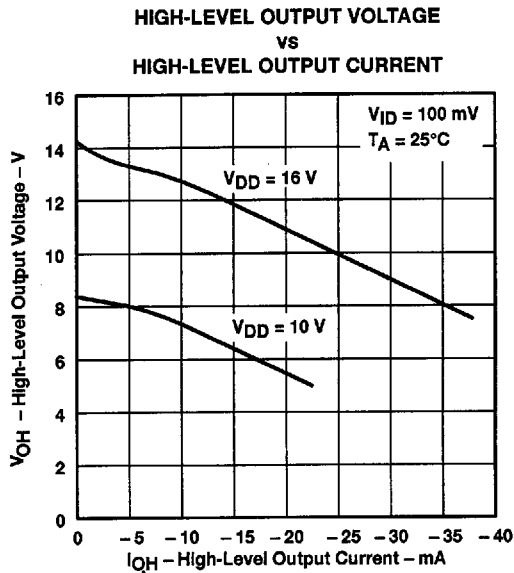

Figure 39

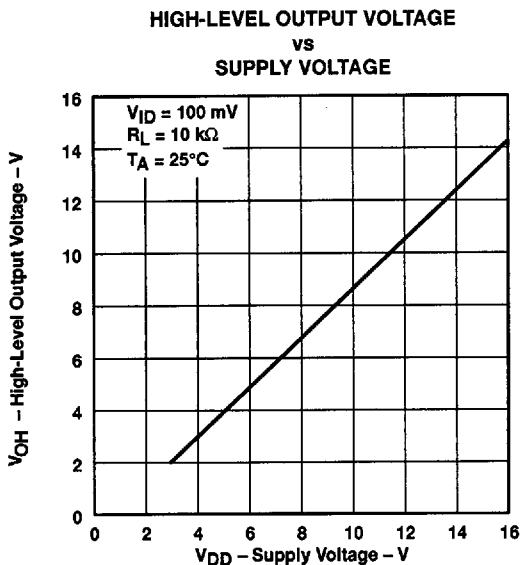

Figure 40

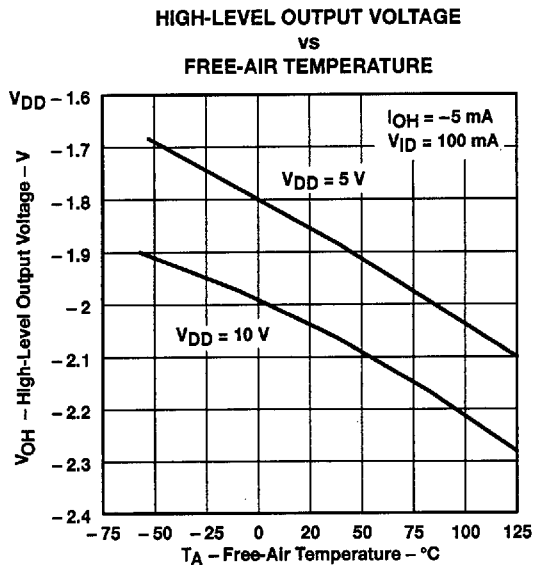

Figure 41

† Data at high and low temperatures are applicable only within the rated operating free-air temperature ranges of the various devices.



POST OFFICE BOX 665303 • DALLAS, TEXAS 75265

TYPICAL CHARACTERISTICS (MEDIUM-BIAS MODE)†

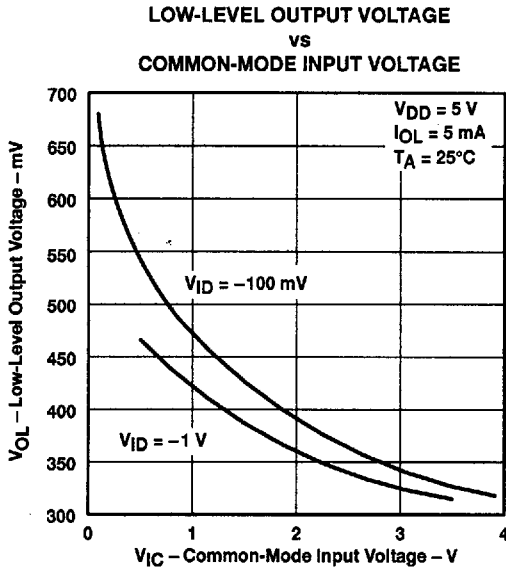

Figure 42

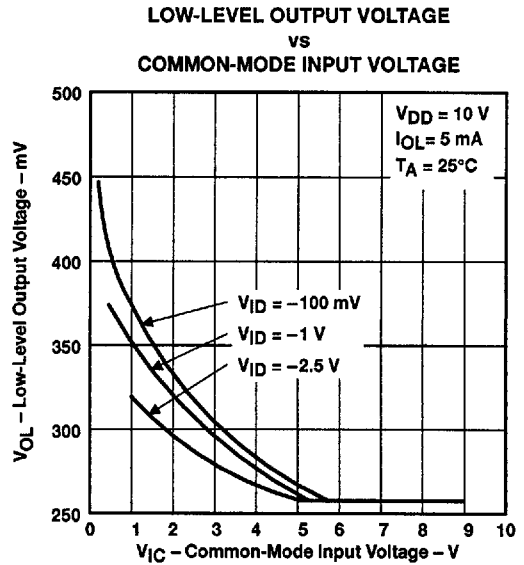

Figure 43

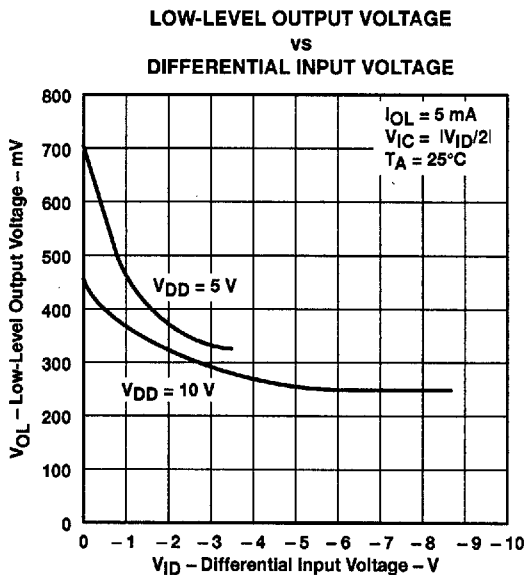

Figure 44

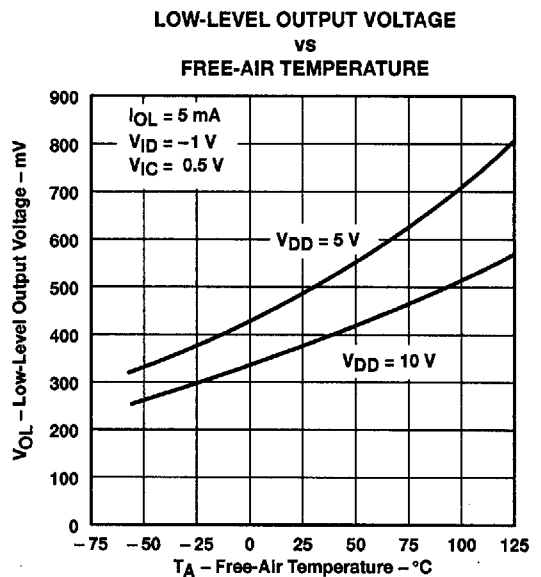

Figure 45

† Data at high and low temperatures are applicable only within the rated operating free-air temperature ranges of the various devices.

TLC271, TLC271A, TLC271B
LinCMOS™ PROGRAMMABLE LOW-POWER
OPERATIONAL AMPLIFIERS

SLOS090A – NOVEMBER 1987 – REVISED AUGUST 1994

TYPICAL CHARACTERISTICS (MEDIUM-BIAS MODE)†

**LOW-LEVEL OUTPUT VOLTAGE
vs
LOW-LEVEL OUTPUT CURRENT**

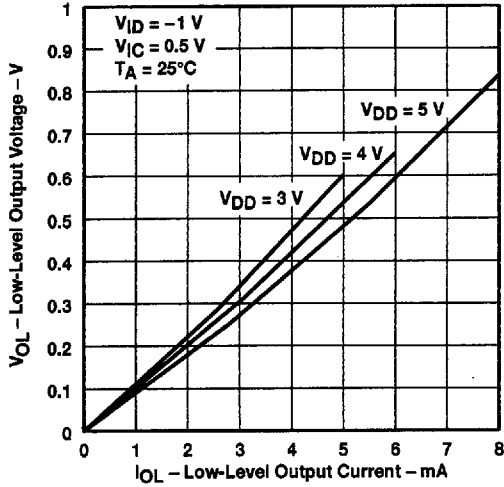

Figure 46

**LOW-LEVEL OUTPUT VOLTAGE
vs
LOW-LEVEL OUTPUT CURRENT**

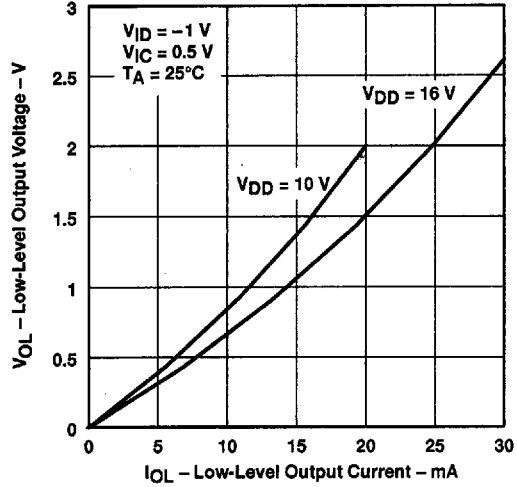

Figure 47

**LARGE-SIGNAL
DIFFERENTIAL VOLTAGE AMPLIFICATION
vs
SUPPLY VOLTAGE**

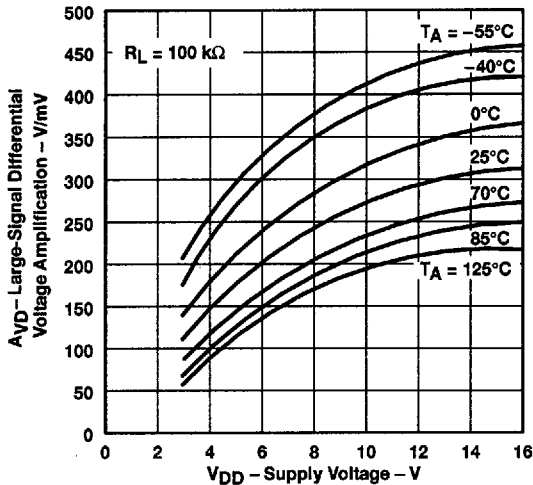

Figure 48

**LARGE-SIGNAL
DIFFERENTIAL VOLTAGE AMPLIFICATION
vs
FREE-AIR TEMPERATURE**

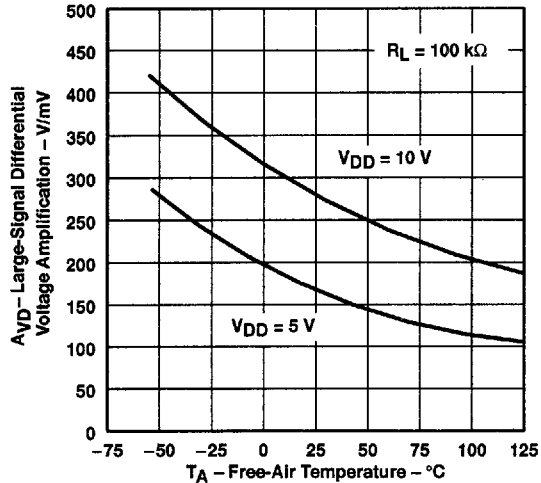

Figure 49

† Data at high and low temperatures are applicable only within the rated operating free-air temperature ranges of the various devices.



TYPICAL CHARACTERISTICS (MEDIUM-BIAS MODE)†

INPUT BIAS CURRENT AND INPUT OFFSET
 CURRENT
 vs
 FREE-AIR TEMPERATURE

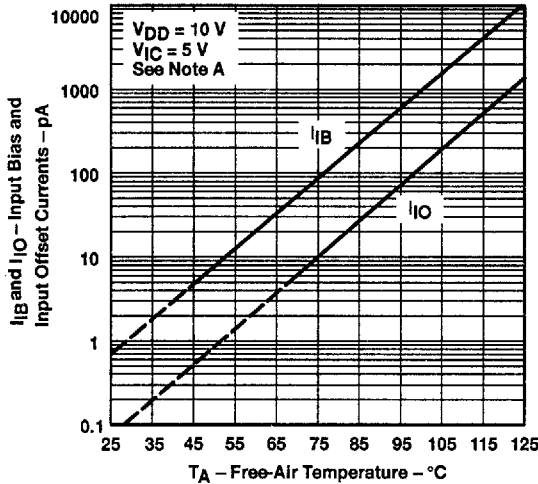

NOTE A: The typical values of input bias current and input offset current below 5 pA were determined mathematically.

Figure 50

MAXIMUM INPUT VOLTAGE
 vs
 SUPPLY VOLTAGE

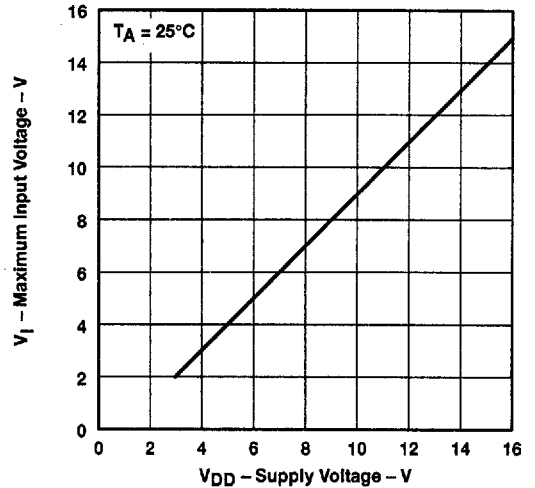

Figure 51

SUPPLY CURRENT
 vs
 SUPPLY VOLTAGE

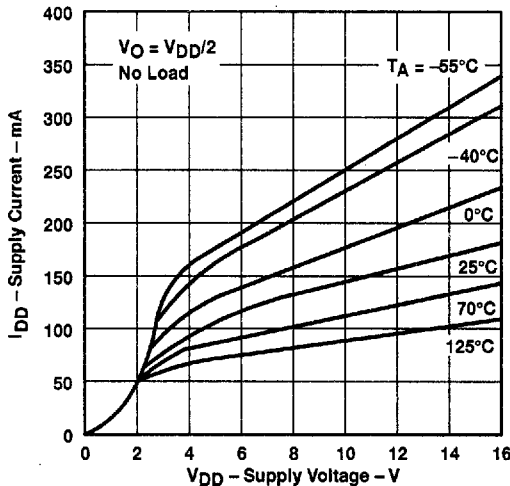

Figure 52

SUPPLY CURRENT
 vs
 FREE-AIR TEMPERATURE

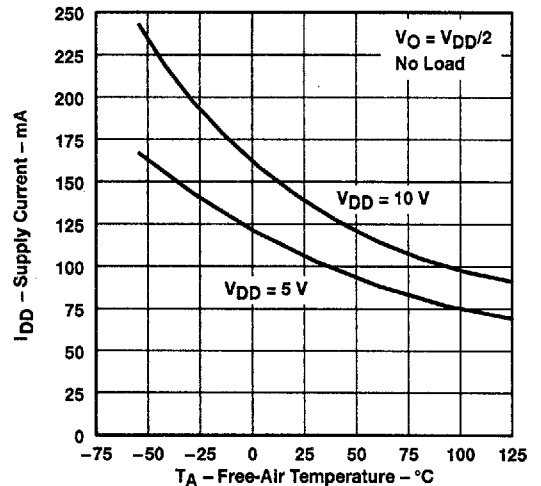

Figure 53

† Data at high and low temperatures are applicable only within the rated operating free-air temperature ranges of the various devices.

TLC271, TLC271A, TLC271B
LinCMOS™ PROGRAMMABLE LOW-POWER
OPERATIONAL AMPLIFIERS

SLOS090A – NOVEMBER 1987 – REVISED AUGUST 1994

TYPICAL CHARACTERISTICS (MEDIUM-BIAS MODE)†

SLEW RATE
vs
SUPPLY VOLTAGE

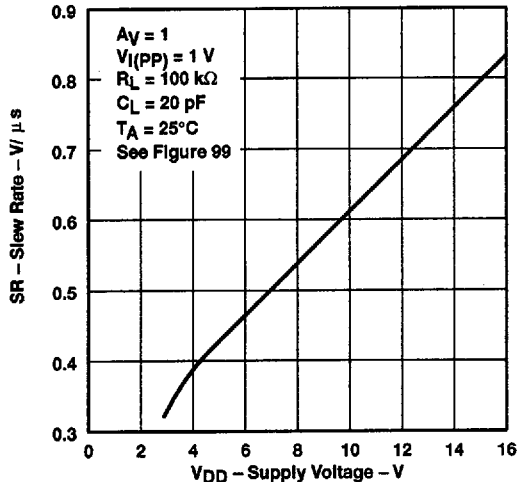

Figure 54

SLEW RATE
vs
FREE-AIR TEMPERATURE

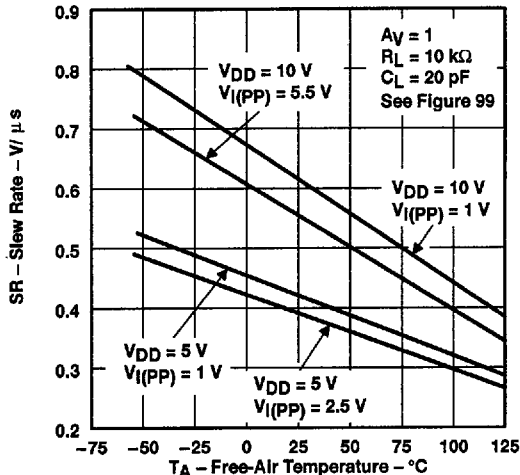

Figure 55

BIAS-SELECT CURRENT
vs
SUPPLY VOLTAGE

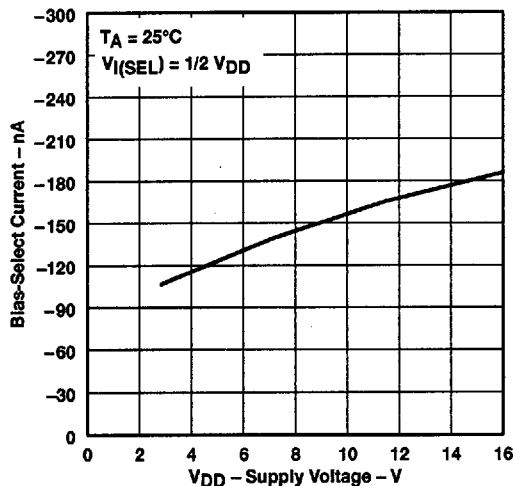

Figure 56

MAXIMUM PEAK-TO-PEAK OUTPUT VOLTAGE
vs
FREQUENCY

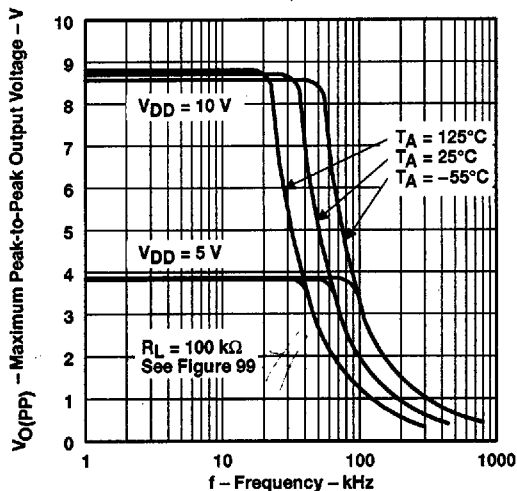

Figure 57

† Data at high and low temperatures are applicable only within the rated operating free-air temperature ranges of the various devices.



POST OFFICE BOX 655309 • DALLAS, TEXAS 75265

TYPICAL CHARACTERISTICS (MEDIUM-BIAS MODE)†

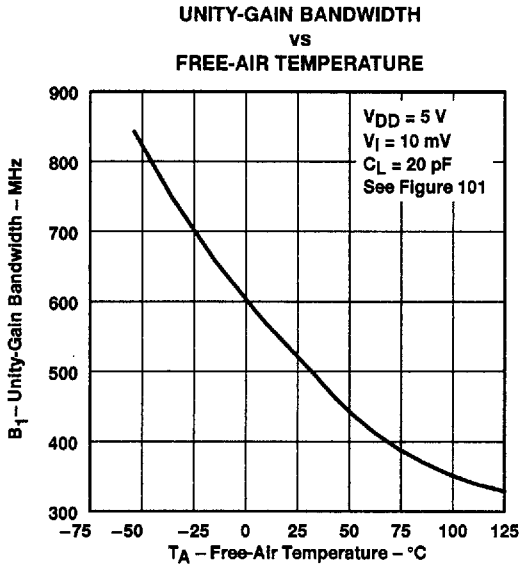

Figure 58

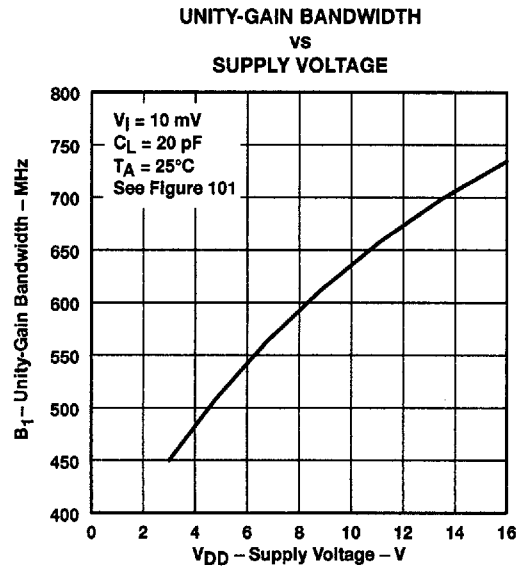

Figure 59

LARGE-SIGNAL DIFFERENTIAL VOLTAGE
 AMPLIFICATION AND PHASE SHIFT
 vs
 FREQUENCY

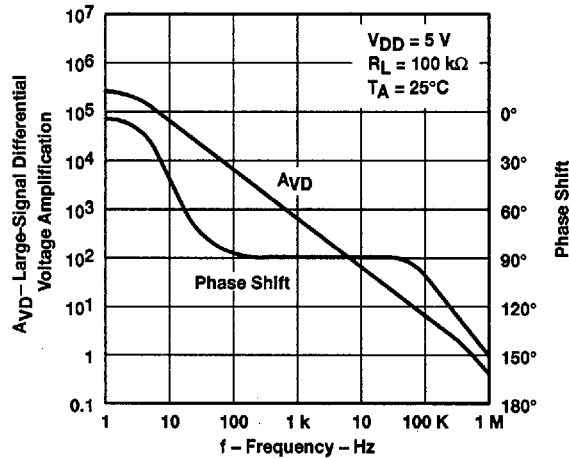

Figure 60

† Data at high and low temperatures are applicable only within the rated operating free-air temperature ranges of the various devices.

TYPICAL CHARACTERISTICS (MEDIUM-BIAS MODE)†

**LARGE-SIGNAL DIFFERENTIAL VOLTAGE
 AMPLIFICATION AND PHASE SHIFT
 vs
 FREQUENCY**

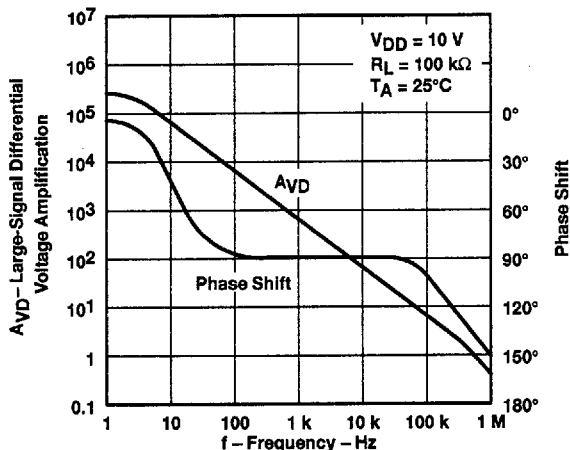

Figure 61

**PHASE MARGIN
 vs
 SUPPLY VOLTAGE**

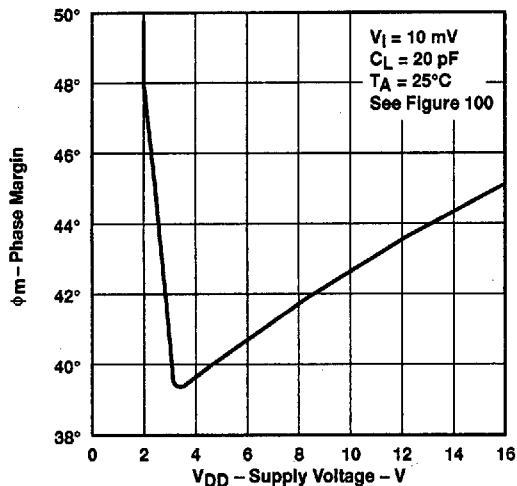

Figure 62

**PHASE MARGIN
 vs
 FREE-AIR TEMPERATURE**

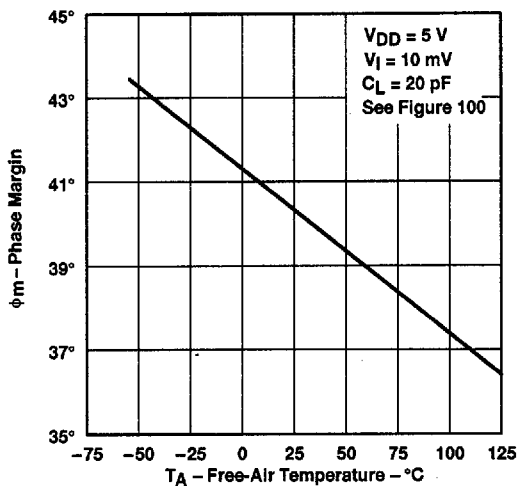

Figure 63

† Data at high and low temperatures are applicable only within the rated operating free-air temperature ranges of the various devices.

TYPICAL CHARACTERISTICS (MEDIUM-BIAS MODE)†

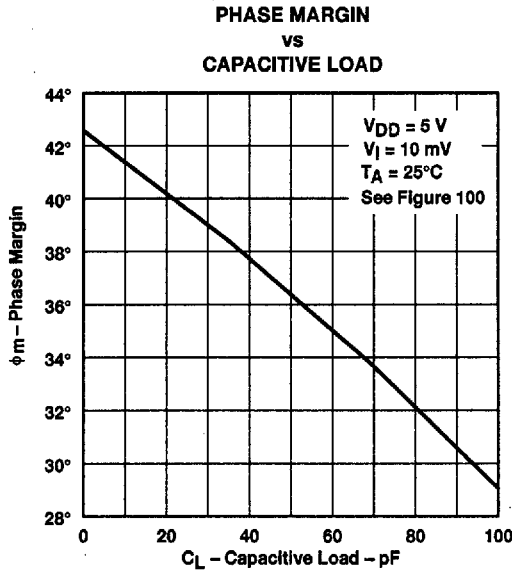

Figure 64

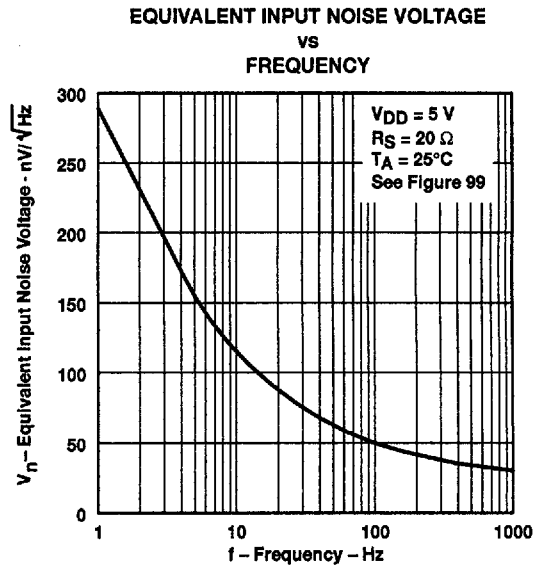

Figure 65

† Data at high and low temperatures are applicable only within the rated operating free-air temperature ranges of the various devices.

TLC271, TLC271A, TLC271B

LinCMOS™ PROGRAMMABLE LOW-POWER OPERATIONAL AMPLIFIERS

SLOS090A - NOVEMBER 1987 - REVISED AUGUST 1994

LOW-BIAS MODE

electrical characteristics at specified free-air temperature (unless otherwise noted)

PARAMETER		TEST CONDITIONS	T _A †	TLC271C, TLC271AC, TLC271BC						UNIT
				V _{DD} = 5 V			V _{DD} = 10 V			
				MIN	TYP	MAX	MIN	TYP	MAX	
V _{IO}	Input offset voltage	V _O = 1.4 V, V _{IC} = 0 V, R _S = 50 Ω, R _I = 1 MΩ	25°C	TLC271C		1.1	10	1.1	10	mV
				Full range		12		12		
			25°C	TLC271AC		0.9	5	0.9	5	
				Full range		6.5		6.5		
			25°C	TLC271BC		0.24	2	0.26	2	
				Full range		3		3		
α _{VIO}	Average temperature coefficient of input offset voltage		25°C to 70°C	1.1		1		μV/°C		
I _{IO}	Input offset current (see Note 4)	V _O = V _{DD} /2, V _{IC} = V _{DD} /2	25°C	0.1		0.1		pA		
			70°C	7	300	8	300			
I _{IB}	Input bias current (see Note 4)	V _O = V _{DD} /2, V _{IC} = V _{DD} /2	25°C	0.6		0.7		pA		
			70°C	40	600	50	600			
V _{ICR}	Common-mode input voltage range (see Note 5)		25°C	-0.2 to 4	-0.3 to 4.2	-0.2 to 9	-0.3 to 9.2	V		
			Full range	-0.2 to 3.5		-0.2 to 8.5		V		
V _{OH}	High-level output voltage	V _{ID} = 100 mV, R _L = 1 MΩ	25°C	3.2	4.1	8	8.9	V		
			0°C	3	4.1	7.8	8.9			
			70°C	3	4.2	7.8	8.9			
V _{OL}	Low-level output voltage	V _{ID} = -100 mV, I _{OL} = 0	25°C	0 50		0 50		mV		
			0°C	0 50		0 50				
			70°C	0 50		0 50				
A _{VD}	Large-signal differential voltage amplification	R _L = 1 MΩ, See Note 6	25°C	50	520	50	870	V/mV		
			0°C	50	700	50	1030			
			70°C	50	380	50	660			
CMRR	Common-mode rejection ratio	V _{IC} = V _{ICRmin}	25°C	65	94	65	97	dB		
			0°C	60	95	60	97			
			70°C	60	95	60	97			
k _{SVR}	Supply-voltage rejection ratio (ΔV _{DD} /ΔV _{IO})	V _O = 1.4 V	25°C	70	97	70	97	dB		
			0°C	60	97	60	97			
			70°C	60	98	60	98			
I _{I(SEL)}	Input current (BIAS SELECT)	V _{I(SEL)} = V _{DD}	25°C	65		95		nA		
I _{DD}	Supply current	V _O = V _{DD} /2, V _{IC} = V _{DD} /2, No load	25°C	10	17	14	23	μA		
			0°C	12	21	18	33			
			70°C	8	14	11	20			

† Full range is 0°C to 70°C.

- NOTES: 4. The typical values of input bias current and input offset current below 5 pA were determined mathematically.
 5. This range also applies to each input individually.
 6. At V_{DD} = 5 V, V_O = 0.25 V to 2 V; at V_{DD} = 10 V, V_O = 1 V to 6 V.

LOW-BIAS MODE

electrical characteristics at specified free-air temperature (unless otherwise noted)

PARAMETER		TEST CONDITIONS	T _A †	TLC271, TLC271AI, TLC271BI						UNIT	
				V _{DD} = 5 V			V _{DD} = 10 V				
				MIN	TYP	MAX	MIN	TYP	MAX		
V _{IO}	Input offset voltage	TLC271I TLC271AI TLC271BI	V _O = 1.4 V, V _{IC} = 0 V, R _S = 50 Ω, R _L = 1 MΩ	25°C	1.1		10	1.1		10	mV
				Full range	13			13			
				25°C	0.9		5	0.9		5	
				Full range	7			7			
				25°C	0.24		2	0.26		2	
				Full range	3.5			3.5			
α _{VIO}	Average temperature coefficient of input offset voltage		25°C to 85°C	1.1			1			μV/°C	
I _{IO}	Input offset current (see Note 4)	V _O = V _{DD} /2, V _{IC} = V _{DD} /2	25°C	0.1			0.1			pA	
			85°C	24		1000	26		1000		
I _{IB}	Input bias current (see Note 4)	V _O = V _{DD} /2, V _{IC} = V _{DD} /2	25°C	0.6			0.7			pA	
			85°C	200		2000	220		2000		
V _{ICR}	Common-mode input voltage range (see Note 5)		25°C	-0.2 to 4	-0.3 to 4.2		-0.2 to 9	-0.3 to 9.2		V	
			Full range	-0.2 to 3.5			-0.2 to 8.5			V	
V _{OH}	High-level output voltage	V _{ID} = 100 mV, R _L = 1 MΩ	25°C	3	4.1		8	8.9		V	
			-40°C	3	4.1		7.8	8.9			
			85°C	3	4.2		7.8	8.9			
V _{OL}	Low-level output voltage	V _{ID} = -100 mV, I _{OL} = 0	25°C		0	50		0	50	mV	
			-40°C		0	50		0	50		
			85°C		0	50		0	50		
A _{VD}	Large-signal differential voltage amplification	R _L = 1 MΩ See Note 6	25°C	50	520		50	870		V/mV	
			-40°C	50	900		50	1550			
			85°C	50	330		50	585			
CMRR	Common-mode rejection ratio	V _{IC} = V _{ICRmin}	25°C	65	94		65	97		dB	
			-40°C	60	95		60	97			
			85°C	60	95		60	98			
k _{SVR}	Supply-voltage rejection ratio (ΔV _{DD} /ΔV _{IO})	V _O = 1.4 V	25°C	70	97		70	97		dB	
			-40°C	60	97		60	97			
			85°C	60	98		60	98			
I _{I(SEL)}	Input current (BIAS SELECT)	V _{I(SEL)} = V _{DD}	25°C	65			95			nA	
I _{DD}	Supply current	V _O = V _{DD} /2, V _{IC} = V _{DD} /2, No load	25°C	10	17		14	23		μA	
			-40°C	16	27		25	43			
			85°C	17	13		10	18			

† Full range is -40 to 85°C.

NOTES: 4. The typical values of input bias current and input offset current below 5 pA were determined mathematically.

5. This range also applies to each input individually.

6. At V_{DD} = 5 V, V_O = 0.25 V to 2 V; at V_{DD} = 10 V, V_O = 1 V to 6 V.

TLC271, TLC271A, TLC271B
LinCMOS™ PROGRAMMABLE LOW-POWER
OPERATIONAL AMPLIFIERS

SLOS090A – NOVEMBER 1987 – REVISED AUGUST 1994

LOW-BIAS MODE

electrical characteristics at specified free-air temperature (unless otherwise noted)

PARAMETER	TEST CONDITIONS	TA†	TLC271M						UNIT
			V _{DD} = 5 V			V _{DD} = 10 V			
			MIN	TYP	MAX	MIN	TYP	MAX	
V _{IO} Input offset voltage	V _O = 1.4 V, V _{IC} = 0 V, R _S = 50 Ω, R _L = 1 MΩ	25°C	1.1		10	1.1		10	mV
		Full range	12			12			
α _{VIO} Average temperature coefficient of input offset voltage		25°C to 125°C	1.4			1.4			μV/°C
I _{IO} Input offset current (see Note 4)	V _O = V _{DD} /2, V _{IC} = V _{DD} /2	25°C	0.1			0.1			pA
		125°C	1.4	15		1.8	15		nA
I _{IB} Input bias current (see Note 4)	V _O = V _{DD} /2, V _{IC} = V _{DD} /2	25°C	0.6			0.7			pA
		125°C	9	35		10	35		nA
V _{ICR} Common-mode input voltage range (see Note 5)		25°C	0 to 4	-0.3 to 4.2		0 to 9	-0.3 to 9.2		V
		Full range	0 to 3.5			0 to 8.5			V
V _{OH} High-level output voltage	V _{ID} = 100 mV, R _L = 1 MΩ	25°C	3.2	4.1		8	8.9		V
		-55°C	3	4.1		7.8	8.8		
		125°C	3	4.2		7.8	9		
V _{OL} Low-level output voltage	V _{ID} = -100 mV, I _{OL} = 0	25°C	0			50	50		mV
		-55°C	0			50	50		
		125°C	0			50	50		
A _{VD} Large-signal differential voltage amplification	R _L = 1 MΩ, See Note 6	25°C	50	520		50	870		V/mV
		-55°C	25	1000		25	1775		
		125°C	25	200		25	380		
CMRR Common-mode rejection ratio	V _{IC} = V _{ICRmin}	25°C	65	94		65	97		dB
		-55°C	60	95		60	97		
		125°C	60	85		60	91		
k _{SVR} Supply-voltage rejection ratio (ΔV _{DD} /ΔV _{IO})	V _O = 1.4 V	25°C	70	97		70	97		dB
		-55°C	60	97		60	97		
		125°C	60	98		60	98		
I _{I(SEL)} Input current (BIAS SELECT)	V _{I(SEL)} = V _{DD}	25°C	65			95			nA
I _{DD} Supply current	V _O = V _{DD} /2, V _{IC} = V _{DD} /2, No load	25°C	10		17	14		23	μA
		-55°C	17		30	28		48	
		125°C	7		12	9		15	

† Full range is -55°C to 125°C.

NOTES: 4. The typical values of input bias current and input offset current below 5 pA were determined mathematically.

5. This range also applies to each input individually.

6. At V_{DD} = 5 V, V_O = 0.25 V to 2 V; at V_{DD} = 10 V, V_O = 1 V to 6 V.

TLC271, TLC271A, TLC271B
LinCMOS™ PROGRAMMABLE LOW-POWER
OPERATIONAL AMPLIFIERS

SLOS080A – NOVEMBER 1987 – REVISED AUGUST 1994

LOW-BIAS MODE

operating characteristics at specified free-air temperature, $V_{DD} = 5\text{ V}$

PARAMETER	TEST CONDITIONS		T_A	TLC271C, TLC271AC, TLC271BC			UNIT
				MIN	TYP	MAX	
SR Slew rate at unity gain	$R_L = 1\text{ M}\Omega$, $C_L = 20\text{ pF}$, See Figure 98	$V_{I(PP)} = 1\text{ V}$	25°C	0.03		V/ μ s	
			0°C	0.04			
			70°C	0.03			
		$V_{I(PP)} = 2.5\text{ V}$	25°C	0.03			
			0°C	0.03			
			70°C	0.02			
V_n Equivalent input noise voltage	$f = 1\text{ kHz}$, See Figure 99	$R_S = 20\ \Omega$	25°C	68		nV/ $\sqrt{\text{Hz}}$	
B _{OM} Maximum output-swing bandwidth	$V_O = V_{OH}$, $R_L = 1\text{ M}\Omega$,	$C_L = 20\text{ pF}$, See Figure 98	25°C	5		kHz	
			0°C	6			
			70°C	4.5			
B ₁ Unity-gain bandwidth	$V_I = 10\text{ mV}$, See Figure 100	$C_L = 20\text{ pF}$,	25°C	85		kHz	
			0°C	100			
			70°C	65			
ϕ_m Phase margin	$V_I = 10\text{ mV}$, $C_L = 20\text{ pF}$,	$f = B_1$, See Figure 100	25°C	34°			
			0°C	36°			
			70°C	30°			

operating characteristics at specified free-air temperature, $V_{DD} = 10\text{ V}$

PARAMETER	TEST CONDITIONS		T_A	TLC271C, TLC271AC, TLC271BC			UNIT
				MIN	TYP	MAX	
SR Slew rate at unity gain	$R_L = 1\text{ M}\Omega$, $C_L = 20\text{ pF}$, See Figure 98	$V_{I(PP)} = 1\text{ V}$	25°C	0.05		V/ μ s	
			0°C	0.05			
			70°C	0.04			
		$V_{I(PP)} = 5.5\text{ V}$	25°C	0.04			
			0°C	0.05			
			70°C	0.04			
V_n Equivalent input noise voltage	$f = 1\text{ kHz}$, See Figure 99	$R_S = 20\ \Omega$	25°C	68		nV/ $\sqrt{\text{Hz}}$	
B _{OM} Maximum output-swing bandwidth	$V_O = V_{OH}$, $R_L = 1\text{ M}\Omega$,	$C_L = 20\text{ pF}$, See Figure 98	25°C	1		kHz	
			0°C	1.3			
			70°C	0.9			
B ₁ Unity-gain bandwidth	$V_I = 10\text{ mV}$, See Figure 100	$C_L = 20\text{ pF}$,	25°C	110		kHz	
			0°C	125			
			70°C	90			
ϕ_m Phase margin	$V_I = 10\text{ mV}$, $C_L = 20\text{ pF}$,	$f = B_1$, See Figure 100	25°C	38°			
			0°C	40°			
			70°C	34°			



TLC271, TLC271A, TLC271B
LinCMOS™ PROGRAMMABLE LOW-POWER
OPERATIONAL AMPLIFIERS

SLOS090A – NOVEMBER 1987 – REVISED AUGUST 1994

LOW-BIAS MODE

operating characteristics at specified free-air temperature, $V_{DD} = 5\text{ V}$

PARAMETER	TEST CONDITIONS		T_A	TLC271, TLC271A, TLC271B			UNIT
				MIN	TYP	MAX	
SR Slew rate at unity gain	$R_L = 1\text{ M}\Omega$, $C_L = 20\text{ pF}$, See Figure 98	$V_{I(PP)} = 1\text{ V}$	25°C	0.03		V/ μ s	
			-40°C	0.04			
			85°C	0.03			
		$V_{I(PP)} = 2.5\text{ V}$	25°C	0.03			
			-40°C	0.04			
			85°C	0.02			
V_n Equivalent input noise voltage	$f = 1\text{ kHz}$, See Figure 99	$R_S = 20\ \Omega$	25°C	68		nV/ $\sqrt{\text{Hz}}$	
BOM Maximum output-swing bandwidth	$V_O = V_{OH}$, $R_L = 1\text{ M}\Omega$	$C_L = 20\text{ pF}$, See Figure 98	25°C	5		kHz	
			-40°C	7			
			85°C	4			
B ₁ Unity-gain bandwidth	$V_I = 10\text{ mV}$, See Figure 100	$C_L = 20\text{ pF}$	25°C	85		MHz	
			-40°C	130			
			85°C	55			
ϕ_m Phase margin	$V_I = 10\text{ mV}$, $C_L = 20\text{ pF}$	$f = B_1$, See Figure 100	25°C	34°			
			-40°C	38°			
			85°C	28°			

operating characteristics at specified free-air temperature, $V_{DD} = 10\text{ V}$

PARAMETER	TEST CONDITIONS		T_A	TLC271C, TLC271AC, TLC271BC			UNIT
				MIN	TYP	MAX	
SR Slew rate at unity gain	$R_L = 1\text{ M}\Omega$, $C_L = 20\text{ pF}$, See Figure 98	$V_{I(PP)} = 1\text{ V}$	25°C	0.05		V/ μ s	
			-40°C	0.06			
			85°C	0.03			
		$V_{I(PP)} = 5.5\text{ V}$	25°C	0.04			
			-40°C	0.05			
			85°C	0.03			
V_n Equivalent input noise voltage	$f = 1\text{ kHz}$, See Figure 99	$R_S = 20\ \Omega$	25°C	68		nV/ $\sqrt{\text{Hz}}$	
BOM Maximum output-swing bandwidth	$V_O = V_{OH}$, $R_L = 1\text{ M}\Omega$	$C_L = 20\text{ pF}$, See Figure 98	25°C	1		kHz	
			-40°C	1.4			
			85°C	0.8			
B ₁ Unity-gain bandwidth	$V_I = 10\text{ mV}$, See Figure 100	$C_L = 20\text{ pF}$	25°C	110		MHz	
			-40°C	155			
			85°C	80			
ϕ_m Phase margin	$V_I = 10\text{ mV}$, $C_L = 20\text{ pF}$	$f = B_1$, See Figure 100	25°C	38°			
			-40°C	42°			
			85°C	32°			

8961724 0093194 36T



LOW-BIAS MODE

operating characteristics at specified free-air temperature, $V_{DD} = 5\text{ V}$

PARAMETER	TEST CONDITIONS	T_A	TLC271M			UNIT
			MIN	TYP	MAX	
SR Slew rate at unity gain	$R_L = 1\text{ M}\Omega$, $C_L = 20\text{ pF}$, See Figure 98	$V_I(\text{PP}) = 1\text{ V}$	25°C	0.03		V/ μs
			-55°C	0.04		
			125°C	0.02		
		$V_I(\text{PP}) = 2.5\text{ V}$	25°C	0.03		
			-55°C	0.04		
			125°C	0.02		
V_n Equivalent input noise voltage	$f = 1\text{ kHz}$, See Figure 99	$R_S = 20\ \Omega$, 25°C	68		nV/ $\sqrt{\text{Hz}}$	
B_{OM} Maximum output-swing bandwidth	$V_O = V_{OH}$, $R_L = 1\text{ M}\Omega$, $C_L = 20\text{ pF}$, See Figure 98	25°C	5		kHz	
		-55°C	8			
		125°C	3			
B_1 Unity-gain bandwidth	$V_I = 10\text{ mV}$, See Figure 100	$C_L = 20\text{ pF}$	25°C	85		kHz
			-55°C	140		
			125°C	45		
			ϕ_m Phase margin	$V_I = 10\text{ mV}$, $C_L = 20\text{ pF}$, $f = B_1$, See Figure 100	25°C	
-55°C	39°					
125°C	25°					

operating characteristics at specified free-air temperature, $V_{DD} = 10\text{ V}$

PARAMETER	TEST CONDITIONS	T_A	TLC271M			UNIT
			MIN	TYP	MAX	
SR Slew rate at unity gain	$R_L = 1\text{ M}\Omega$, $C_L = 20\text{ pF}$, See Figure 98	$V_I(\text{PP}) = 1\text{ V}$	25°C	0.05		V/ μs
			-55°C	0.06		
			125°C	0.03		
		$V_I(\text{PP}) = 5.5\text{ V}$	25°C	0.04		
			-55°C	0.06		
			125°C	0.03		
V_n Equivalent input noise voltage	$f = 1\text{ kHz}$, See Figure 99	$R_S = 20\ \Omega$, 25°C	68		nV/ $\sqrt{\text{Hz}}$	
B_{OM} Maximum output-swing bandwidth	$V_O = V_{OH}$, $R_L = 1\text{ M}\Omega$, $C_L = 20\text{ pF}$, See Figure 98	25°C	1		kHz	
		-55°C	1.5			
		125°C	0.7			
B_1 Unity-gain bandwidth	$V_I = 10\text{ mV}$, See Figure 100	$C_L = 20\text{ pF}$	25°C	110		kHz
			-55°C	165		
			125°C	70		
ϕ_m Phase margin	$V_I = 10\text{ mV}$, $C_L = 20\text{ pF}$, $f = B_1$, See Figure 100	25°C	38°			
		-55°C	43°			
		125°C	29°			

TLC271, TLC271A, TLC271B
LinCMOS™ PROGRAMMABLE LOW-POWER
OPERATIONAL AMPLIFIERS

SLOS090A – NOVEMBER 1987 – REVISED AUGUST 1994

TYPICAL CHARACTERISTICS (LOW-BIAS MODE)

Table of Graphs

			FIGURE
V_{IO}	Input offset voltage	Distribution	66, 67
αV_{IO}	Temperature coefficient	Distribution	68, 69
V_{OH}	High-level output voltage	vs High-level output current	70, 71
		vs Supply voltage	72
		vs Free-air temperature	73
V_{OL}	Low-level output voltage	vs Common-mode input voltage	74, 75
		vs Differential input voltage	76
		vs Free-air temperature	77
		vs Low-level output current	78, 79
A_{VD}	Large-signal differential voltage amplification	vs Supply voltage	80
		vs Free-air temperature	81
		vs Frequency	92, 93
I_{IB}	Input bias current	vs Free-air temperature	82
I_{IQ}	Input offset current	vs Free-air temperature	82
V_I	Maximum input voltage	vs Supply voltage	83
I_{DD}	Supply current	vs Supply voltage	84
		vs Free-air temperature	85
SR	Slew rate	vs Supply voltage	86
		vs Free-air temperature	87
	Bias-select current	vs Supply voltage	88
$V_{O(PP)}$	Maximum peak-to-peak output voltage	vs Frequency	89
B_1	Unity-gain bandwidth	vs Free-air temperature	90
		vs Supply voltage	91
ϕ_m	Phase margin	vs Supply voltage	94
		vs Free-air temperature	95
		vs Load capacitance	96
V_n	Equivalent input noise voltage	vs Frequency	97
		Phase shift	92, 93

TYPICAL CHARACTERISTICS (LOW-BIAS MODE)†

DISTRIBUTION OF TLC271
 INPUT OFFSET VOLTAGE

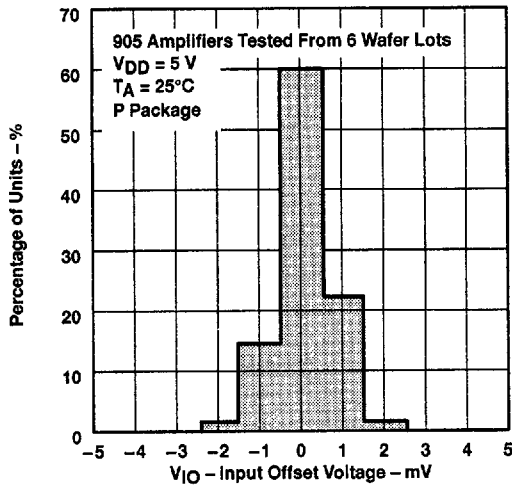

Figure 66

DISTRIBUTION OF TLC271
 INPUT OFFSET VOLTAGE

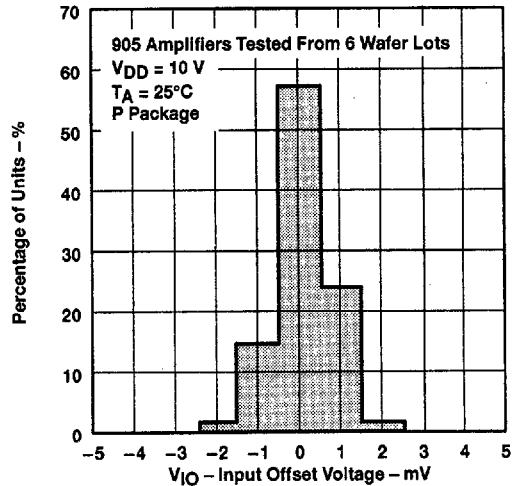

Figure 67

DISTRIBUTION OF TLC271
 INPUT OFFSET VOLTAGE
 TEMPERATURE COEFFICIENT

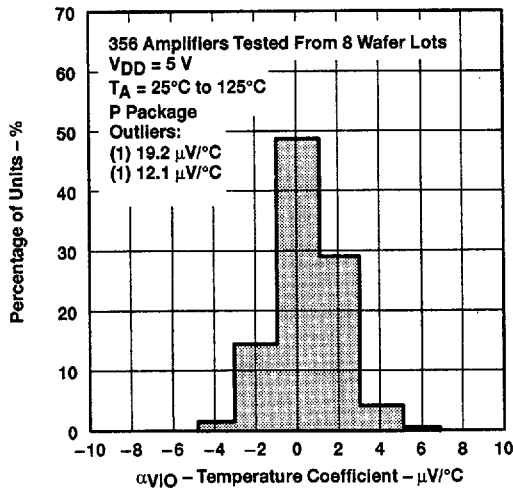

Figure 68

DISTRIBUTION OF TLC271
 INPUT OFFSET VOLTAGE
 TEMPERATURE COEFFICIENT

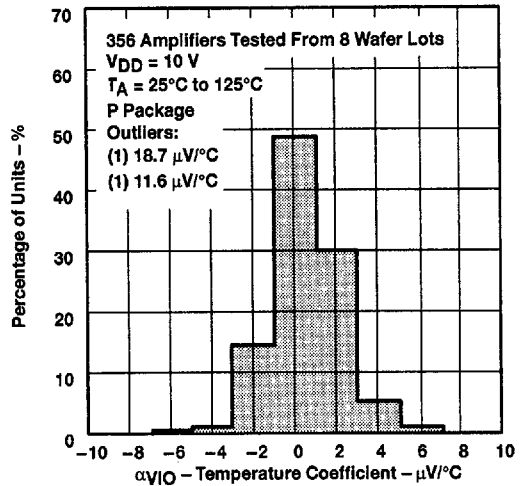

Figure 69

† Data at high and low temperatures are applicable only within the rated operating free-air temperature ranges of the various devices.

TLC271, TLC271A, TLC271B
LinCMOS™ PROGRAMMABLE LOW-POWER
OPERATIONAL AMPLIFIERS

SLOS090A – NOVEMBER 1987 – REVISED AUGUST 1994

TYPICAL CHARACTERISTICS (LOW-BIAS MODE)†

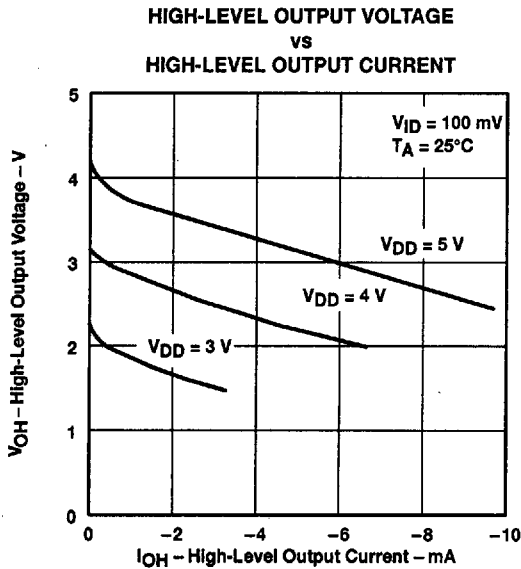

Figure 70

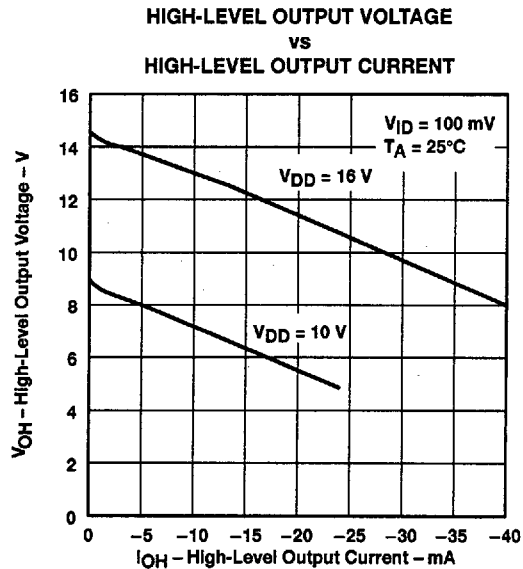

Figure 71

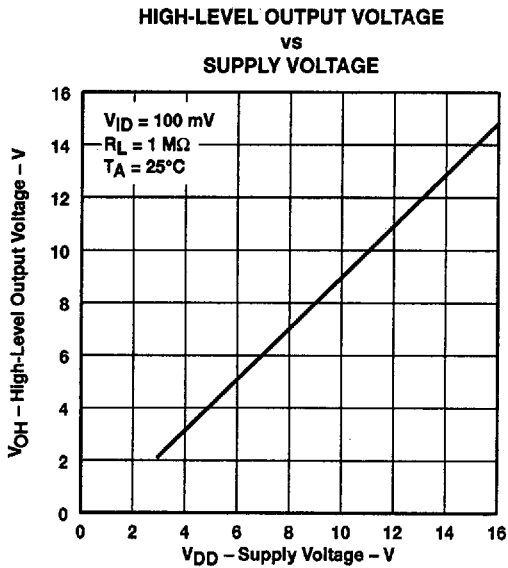

Figure 72

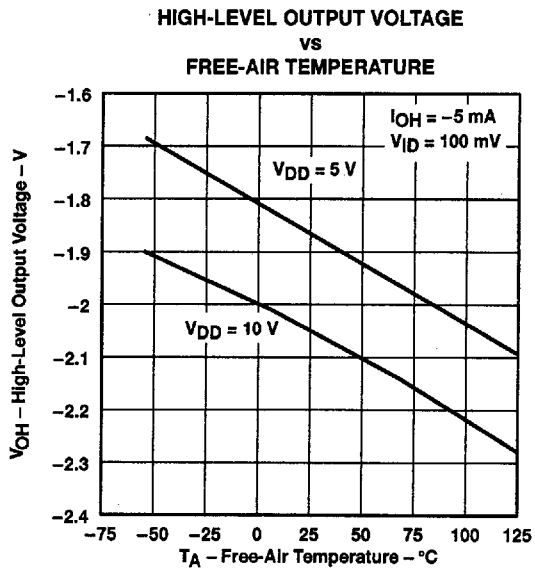

Figure 73

† Data at high and low temperatures are applicable only within the rated operating free-air temperature ranges of the various devices.



POST OFFICE BOX 655303 • DALLAS, TEXAS 75265

TYPICAL CHARACTERISTICS (LOW-BIAS MODE)†

LOW-LEVEL OUTPUT VOLTAGE
 vs
 COMMON-MODE INPUT VOLTAGE

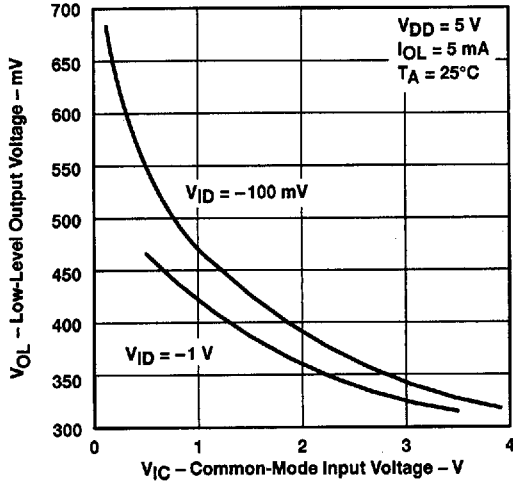

Figure 74

LOW-LEVEL OUTPUT VOLTAGE
 vs
 COMMON-MODE INPUT VOLTAGE

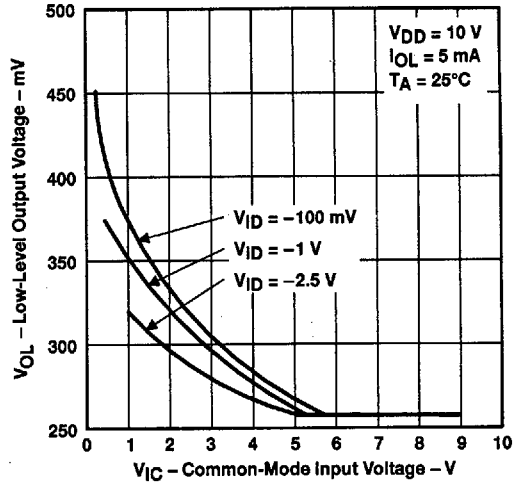

Figure 75

LOW-LEVEL OUTPUT VOLTAGE
 vs
 DIFFERENTIAL INPUT VOLTAGE

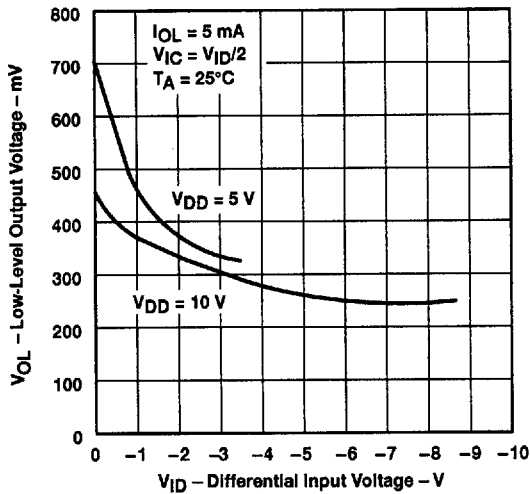

Figure 76

LOW-LEVEL OUTPUT VOLTAGE
 vs
 FREE-AIR TEMPERATURE

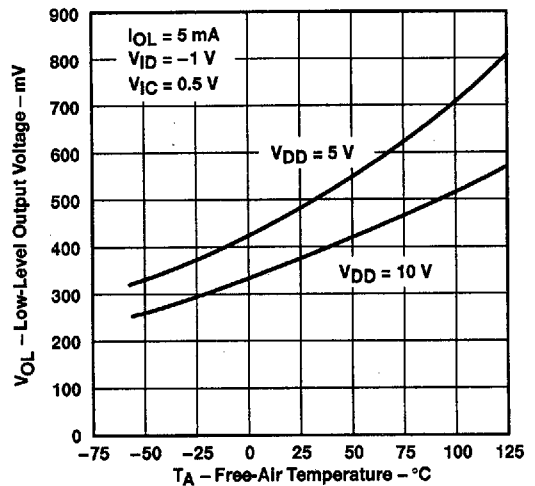

Figure 77

† Data at high and low temperatures are applicable only within the rated operating free-air temperature ranges of the various devices.

TLC271, TLC271A, TLC271B
LinCMOS™ PROGRAMMABLE LOW-POWER
OPERATIONAL AMPLIFIERS

SLOS090A - NOVEMBER 1987 - REVISED AUGUST 1994

TYPICAL CHARACTERISTICS (LOW-BIAS MODE)†

**LOW-LEVEL OUTPUT VOLTAGE
 VS
 LOW-LEVEL OUTPUT CURRENT**

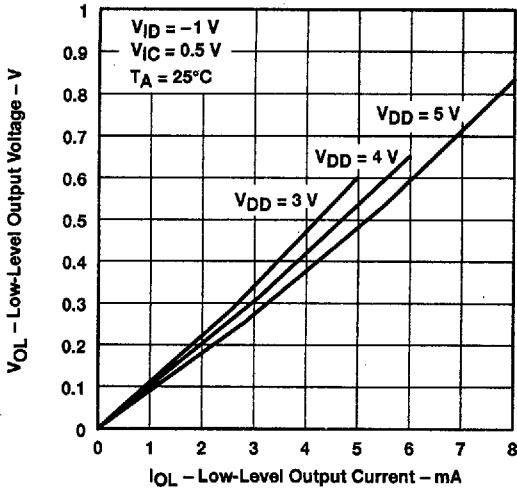

Figure 78

**LOW-LEVEL OUTPUT VOLTAGE
 VS
 LOW-LEVEL OUTPUT CURRENT**

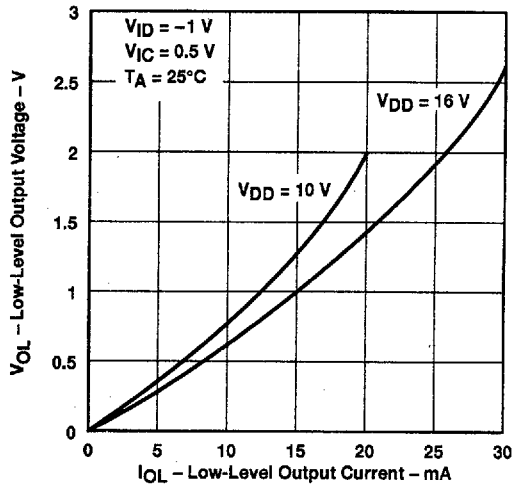

Figure 79

**LARGE-SIGNAL
 DIFFERENTIAL VOLTAGE AMPLIFICATION
 VS
 SUPPLY VOLTAGE**

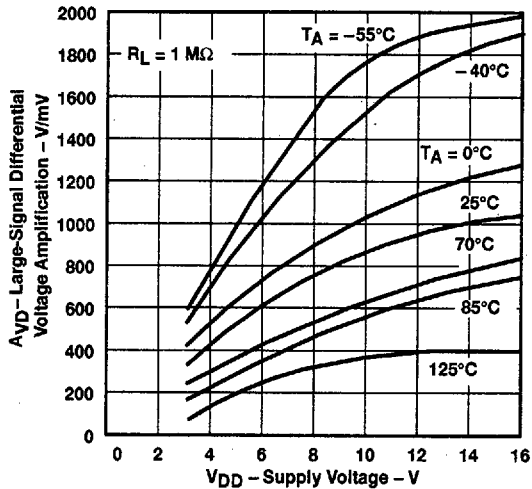

Figure 80

**LARGE-SIGNAL
 DIFFERENTIAL VOLTAGE AMPLIFICATION
 VS
 FREE-AIR TEMPERATURE**

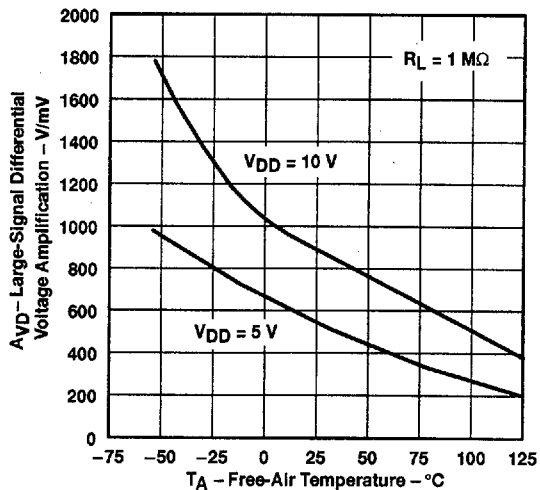

Figure 81

† Data at high and low temperatures are applicable only within the rated operating free-air temperature ranges of the various devices.



POST OFFICE BOX 655303 • DALLAS, TEXAS 75265

TYPICAL CHARACTERISTICS (LOW-BIAS MODE)†

INPUT BIAS CURRENT AND INPUT OFFSET CURRENT
 vs
 FREE-AIR TEMPERATURE

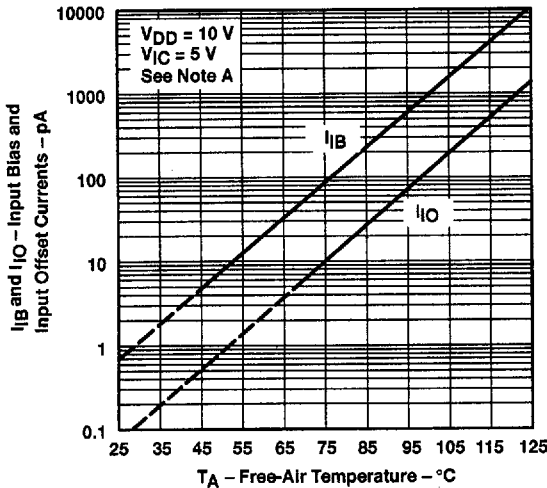

NOTE A: The typical values of input bias current and input offset current below 5 pA were determined mathematically.

Figure 82

MAXIMUM INPUT VOLTAGE
 vs
 SUPPLY VOLTAGE

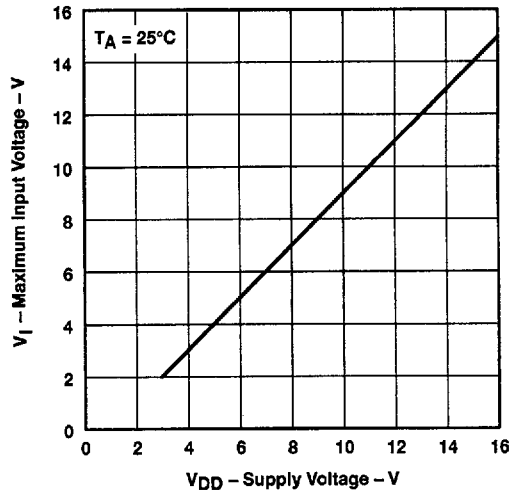

Figure 83

SUPPLY CURRENT
 vs
 SUPPLY VOLTAGE

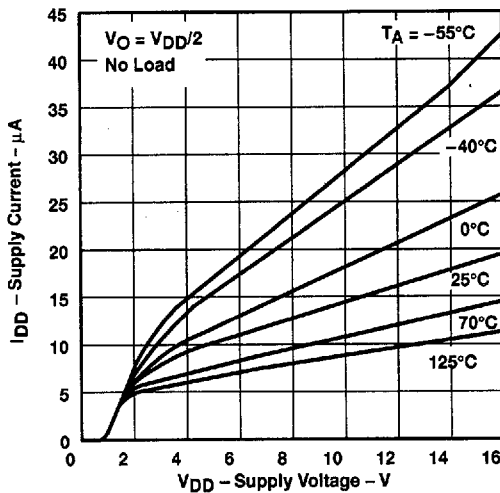

Figure 84

SUPPLY CURRENT
 vs
 FREE-AIR TEMPERATURE

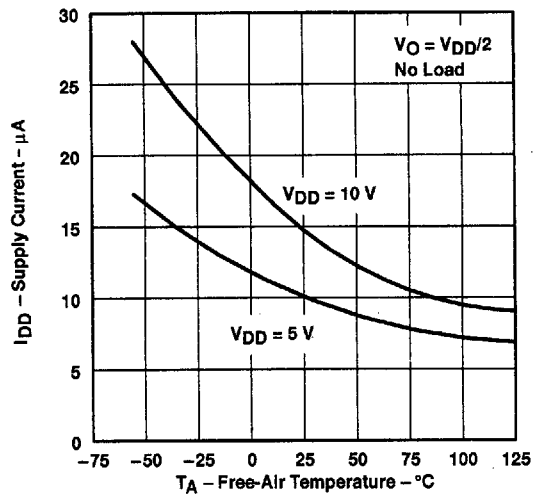

Figure 85

† Data at high and low temperatures are applicable only within the rated operating free-air temperature ranges of the various devices.

TLC271, TLC271A, TLC271B
LinCMOS™ PROGRAMMABLE LOW-POWER
OPERATIONAL AMPLIFIERS

SLOS090A—NOVEMBER 1987—REVISED AUGUST 1994

TYPICAL CHARACTERISTICS (LOW-BIAS MODE)†

SLEW RATE
vs
SUPPLY VOLTAGE

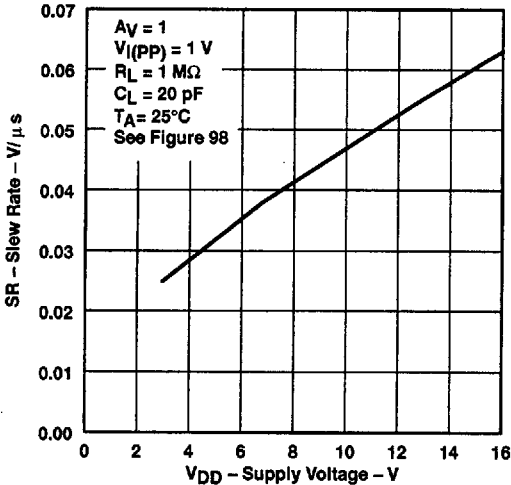

Figure 86

SLEW RATE
vs
FREE-AIR TEMPERATURE

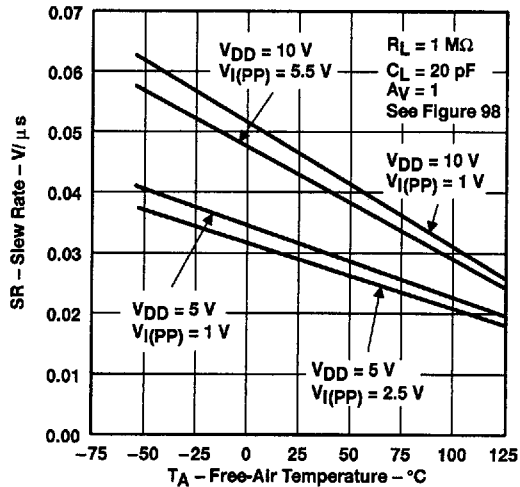

Figure 87

BIAS-SELECT CURRENT
vs
SUPPLY VOLTAGE

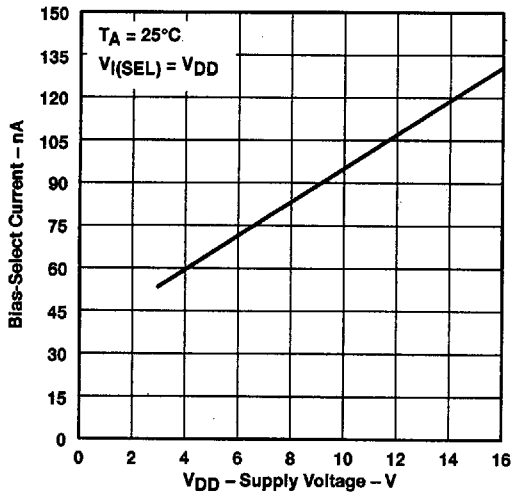

Figure 88

MAXIMUM PEAK-TO-PEAK OUTPUT VOLTAGE
vs
FREQUENCY

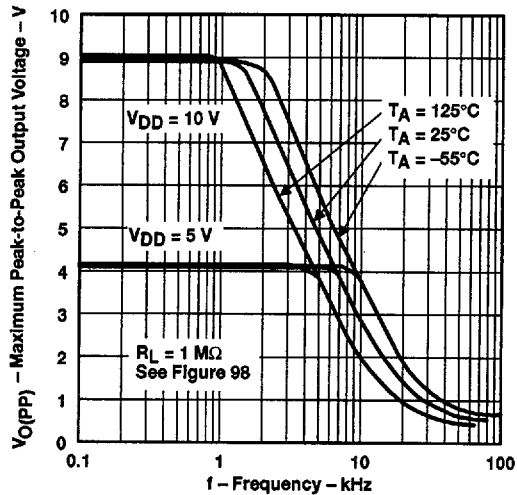

Figure 89

† Data at high and low temperatures are applicable only within the rated operating free-air temperature ranges of the various devices.



POST OFFICE BOX 655303 • DALLAS, TEXAS 75265

TYPICAL CHARACTERISTICS (LOW-BIAS MODE)†

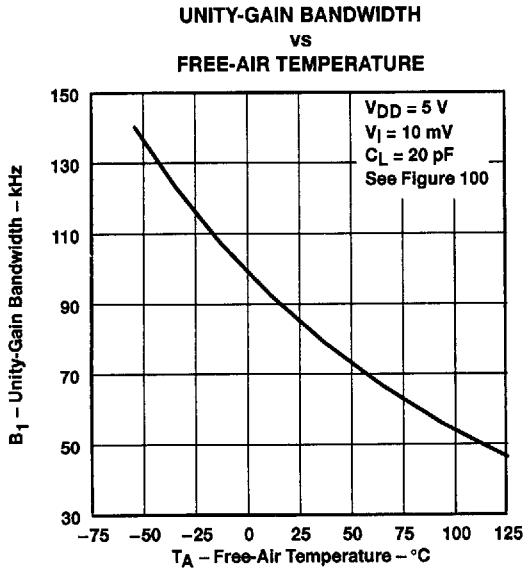

Figure 90

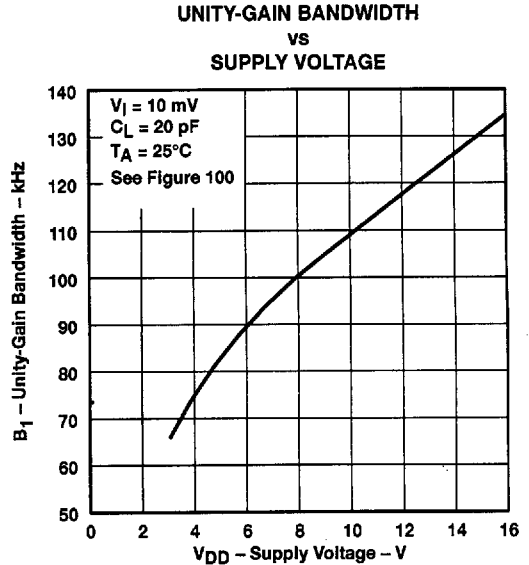

Figure 91

LARGE-SIGNAL DIFFERENTIAL VOLTAGE
 AMPLIFICATION AND PHASE SHIFT
 vs
 FREQUENCY

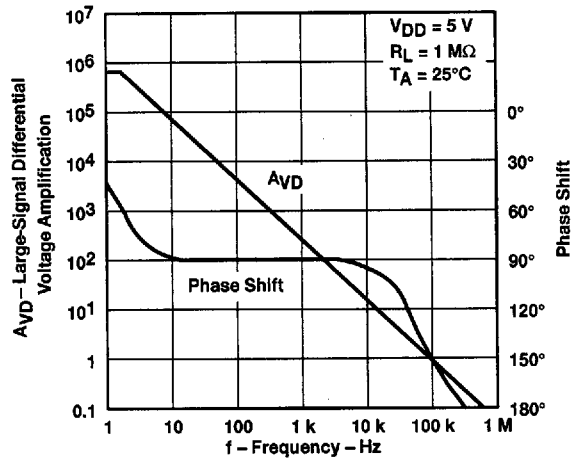

Figure 92

† Data at high and low temperatures are applicable only within the rated operating free-air temperature ranges of the various devices.

TLC271, TLC271A, TLC271B
LinCMOS™ PROGRAMMABLE LOW-POWER
OPERATIONAL AMPLIFIERS

SLOS090A – NOVEMBER 1987 – REVISED AUGUST 1994

TYPICAL CHARACTERISTICS (LOW-BIAS MODE)†

**LARGE-SIGNAL DIFFERENTIAL VOLTAGE
AMPLIFICATION AND PHASE SHIFT
VS
FREQUENCY**

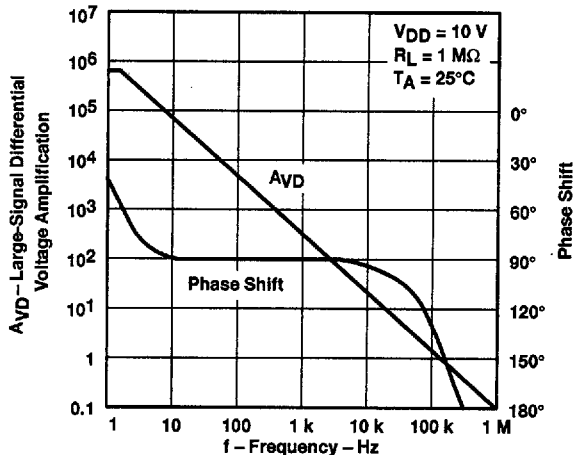

Figure 93

**PHASE MARGIN
VS
SUPPLY VOLTAGE**

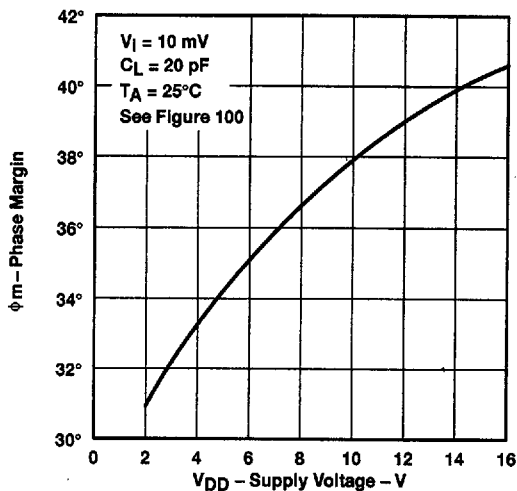

Figure 94

**PHASE MARGIN
VS
FREE-AIR TEMPERATURE**

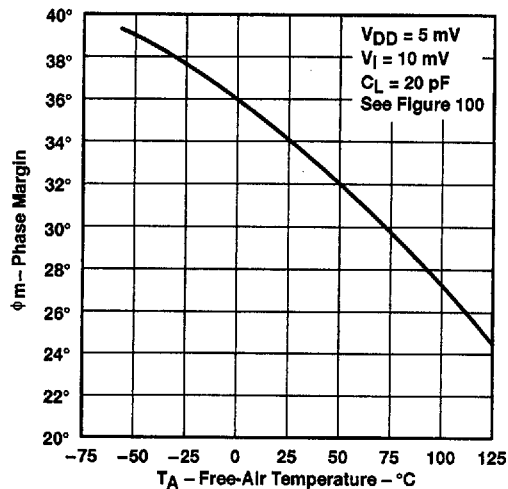

Figure 95

† Data at high and low temperatures are applicable only within the rated operating free-air temperature ranges of the various devices.



POST OFFICE BOX 655303 • DALLAS, TEXAS 75265

TYPICAL CHARACTERISTICS (LOW-BIAS MODE)†

PHASE MARGIN
 vs
 CAPACITIVE LOAD

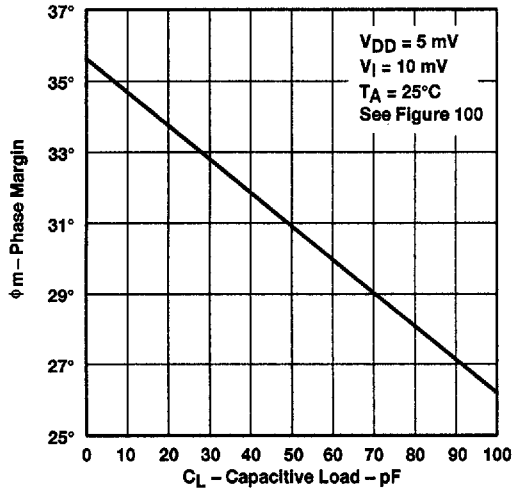

Figure 96

EQUIVALENT INPUT NOISE VOLTAGE
 vs
 FREQUENCY

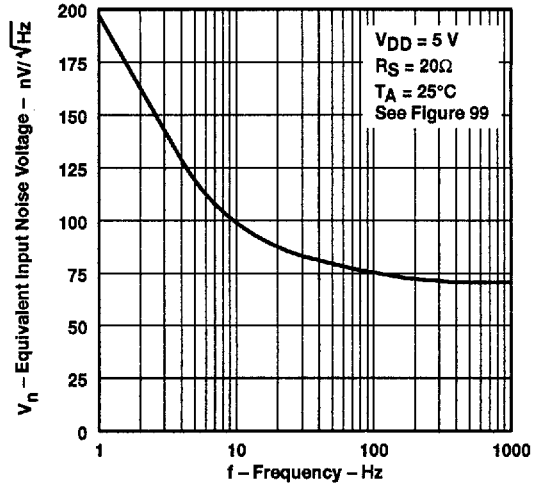

Figure 97

† Data at high and low temperatures are applicable only within the rated operating free-air temperature ranges of the various devices.

TLC271, TLC271A, TLC271B
LinCMOS™ PROGRAMMABLE LOW-POWER
OPERATIONAL AMPLIFIERS

SLOS090A – NOVEMBER 1987 – REVISED AUGUST 1994

PARAMETER MEASUREMENT INFORMATION

single-supply versus split-supply test circuits

Because the TLC271 is optimized for single-supply operation, circuit configurations used for the various tests often present some inconvenience since the input signal, in many cases, must be offset from ground. This inconvenience can be avoided by testing the device with split supplies and the output load tied to the negative rail. A comparison of single-supply versus split-supply test circuits is shown below. The use of either circuit gives the same result.

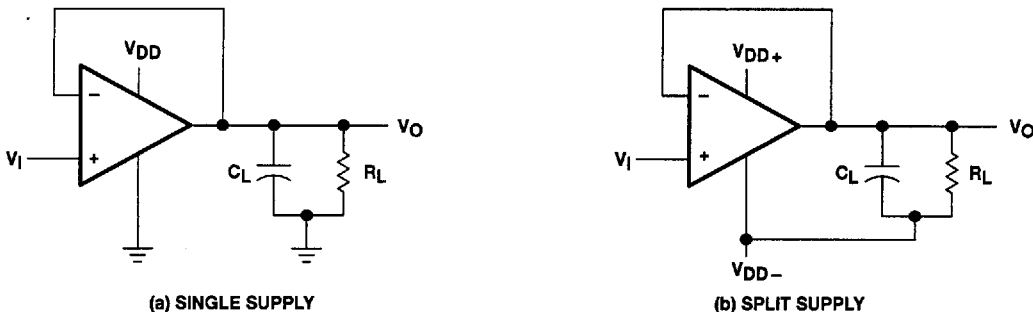

Figure 98. Unity-Gain Amplifier

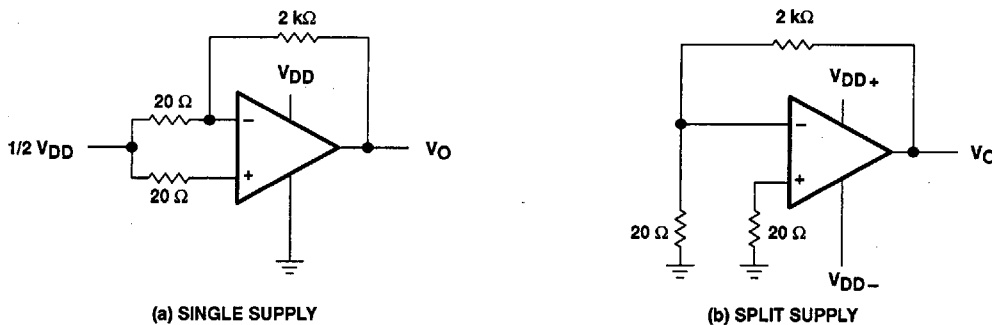

Figure 99. Noise-Test Circuit

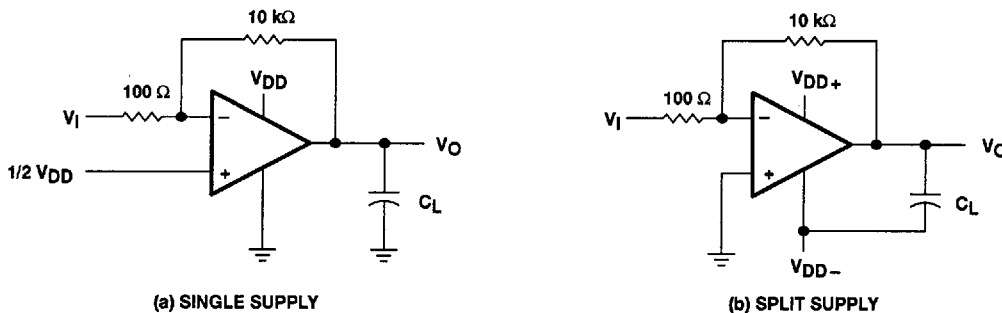

Figure 100. Gain-of-100 Inverting Amplifier

PARAMETER MEASUREMENT INFORMATION

input bias current

Because of the high input impedance of the TLC271 operational amplifiers, attempts to measure the input bias current can result in erroneous readings. The bias current at normal room ambient temperature is typically less than 1 pA, a value that is easily exceeded by leakages on the test socket. Two suggestions are offered to avoid erroneous measurements:

1. Isolate the device from other potential leakage sources. Use a grounded shield around and between the device inputs (see Figure 101). Leakages that would otherwise flow to the inputs are shunted away.
2. Compensate for the leakage of the test socket by actually performing an input bias current test (using a picoammeter) with no device in the test socket. The actual input bias current can then be calculated by subtracting the open-socket leakage readings from the readings obtained with a device in the test socket.

One word of caution: many automatic testers as well as some bench-top operational amplifier testers use the servo-loop technique with a resistor in series with the device input to measure the input bias current (the voltage drop across the series resistor is measured and the bias current is calculated). This method requires that a device be inserted into the test socket to obtain a correct reading; therefore, an open-socket reading is not feasible using this method.

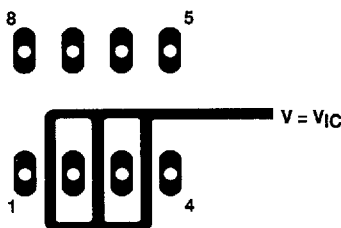

Figure 101. Isolation Metal Around Device inputs (JG and P packages)

low-level output voltage

To obtain low-supply-voltage operation, some compromise is necessary in the input stage. This compromise results in the device low-level output being dependent on both the common-mode input voltage level as well as the differential input voltage level. When attempting to correlate low-level output readings with those quoted in the electrical specifications, these two conditions should be observed. If conditions other than these are to be used, please refer to the Typical Characteristics section of this data sheet.

input offset voltage temperature coefficient

Erroneous readings often result from attempts to measure temperature coefficient of input offset voltage. This parameter is actually a calculation using input offset voltage measurements obtained at two different temperatures. When one (or both) of the temperatures is below freezing, moisture can collect on both the device and the test socket. This moisture results in leakage and contact resistance which can cause erroneous input offset voltage readings. The isolation techniques previously mentioned have no effect on the leakage since the moisture also covers the isolation metal itself, thereby rendering it useless. It is suggested that these measurements be performed at temperatures above freezing to minimize error.

full-power response

Full-power response, the frequency above which the amplifier slew rate limits the output voltage swing, is often specified two ways: full-linear response and full-peak response. The full-linear response is generally measured

TLC271, TLC271A, TLC271B
LinCMOS™ PROGRAMMABLE LOW-POWER
OPERATIONAL AMPLIFIERS

SLOS090A – NOVEMBER 1987 – REVISED AUGUST 1994

PARAMETER MEASUREMENT INFORMATION

full-power response (continued)

by monitoring the distortion level of the output while increasing the frequency of a sinusoidal input signal until the maximum frequency is found above which the output contains significant distortion. The full-peak response is defined as the maximum output frequency, without regard to distortion, above which full peak-to-peak output swing cannot be maintained.

Because there is no industry-wide accepted value for significant distortion, the full-peak response is specified in this data sheet and is measured using the circuit of Figure 98. The initial setup involves the use of a sinusoidal input to determine the maximum peak-to-peak output of the device (the amplitude of the sinusoidal wave is increased until clipping occurs). The sinusoidal wave is then replaced with a square wave of the same amplitude. The frequency is then increased until the maximum peak-to-peak output can no longer be maintained (Figure 102). A square wave is used to allow a more accurate determination of the point at which the maximum peak-to-peak output is reached.

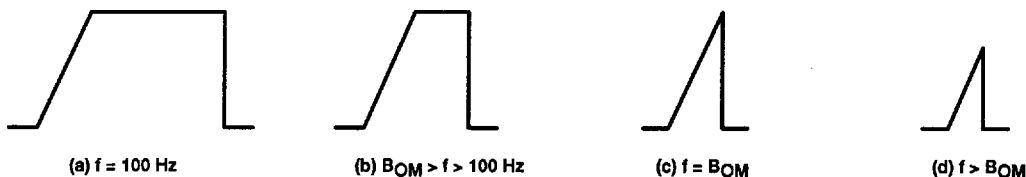

Figure 102. Full-Power-Response Output Signal

test time

Inadequate test time is a frequent problem, especially when testing CMOS devices in a high-volume, short-test-time environment. Internal capacitances are inherently higher in CMOS than in bipolar and BiFET devices, and require longer test times than their bipolar and BiFET counterparts. The problem becomes more pronounced with reduced supply levels and lower temperatures.

APPLICATION INFORMATION

single-supply operation

While the TLC271 performs well using dual power supplies (also called balanced or split supplies), the design is optimized for single-supply operation. This includes an input common mode voltage range that encompasses ground as well as an output voltage range that pulls down to ground. The supply voltage range extends down to 3 V (C-suffix types), thus allowing operation with supply levels commonly available for TTL and HCMOS; however, for maximum dynamic range, 16-V single-supply operation is recommended.

Many single-supply applications require that a voltage be applied to one input to establish a reference level that is above ground. A resistive voltage divider is usually sufficient to establish this reference level (see Figure 103). The low input bias current consumption of the TLC271 permits the use of very large resistive values to implement the voltage divider, thus minimizing power consumption.

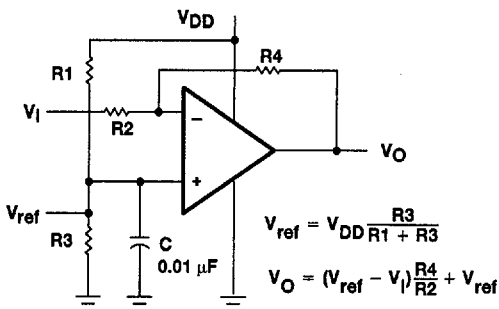

Figure 103. Inverting Amplifier With Voltage Reference

$$V_{ref} = V_{DD} \frac{R3}{R1 + R3}$$

$$V_O = (V_{ref} - V_1) \frac{R4}{R2} + V_{ref}$$

single-supply operation (continued)

The TLC271 works well in conjunction with digital logic; however, when powering both linear devices and digital logic from the same power supply, the following precautions are recommended:

1. Power the linear devices from separate bypassed supply lines (see Figure 104); otherwise, the linear device supply rails can fluctuate due to voltage drops caused by high switching currents in the digital logic.
2. Use proper bypass techniques to reduce the probability of noise-induced errors. Single capacitive decoupling is often adequate; however, RC decoupling may be necessary in high-frequency applications.

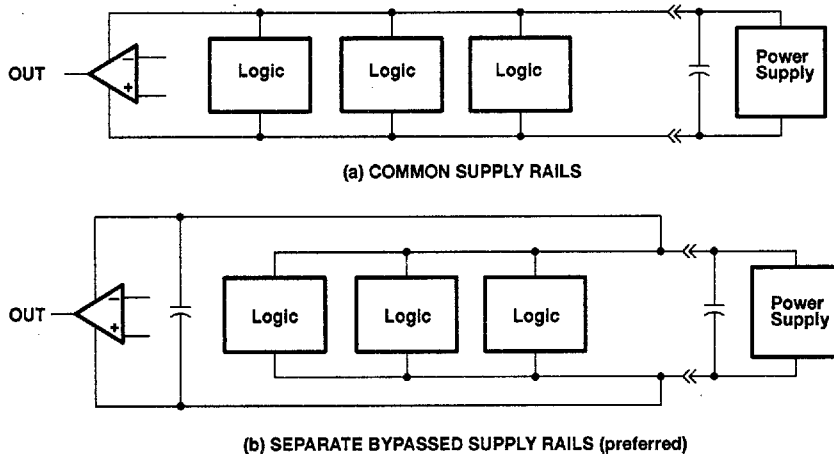

Figure 104. Common Versus Separate Supply Rails

input offset voltage nulling

The TLC271 offers external input offset null control. Nulling of the input offset voltage may be achieved by adjusting a 25-k Ω potentiometer connected between the offset null terminals with the wiper connected as shown in Figure 105. The amount of nulling range varies with the bias selection. In the high-bias mode, the nulling range allows the maximum offset voltage specified to be trimmed to zero. In low-bias and medium-bias modes, total nulling may not be possible.

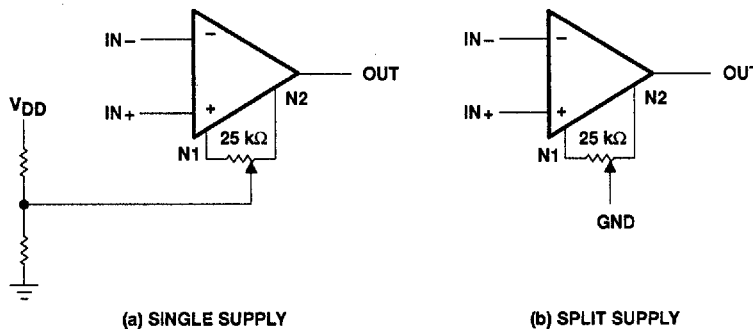

Figure 105. Input Offset Voltage Null Circuit

TLC271, TLC271A, TLC271B
LinCMOS™ PROGRAMMABLE LOW-POWER
OPERATIONAL AMPLIFIERS

SLOS090A – NOVEMBER 1987 – REVISED AUGUST 1994

APPLICATION INFORMATION

bias selection

Bias selection is achieved by connecting the bias select pin to one of the three voltage levels (see Figure 106). For medium-bias applications, R is recommended that the bias select pin be connected to the mid-point between the supply rails. This is a simple procedure in split-supply applications, since this point is ground. In single-supply applications, the medium-bias mode necessitates using a voltage divider as indicated. The use of large-value resistors in the voltage divider reduces the current drain of the divider from the supply line. However, large-value resistors used in conjunction with a large-value capacitor requires significant time to charge up to the supply midpoint after the supply is switched on. A voltage other than the midpoint may be used if it is within the voltages specified in the table of Figure 106.

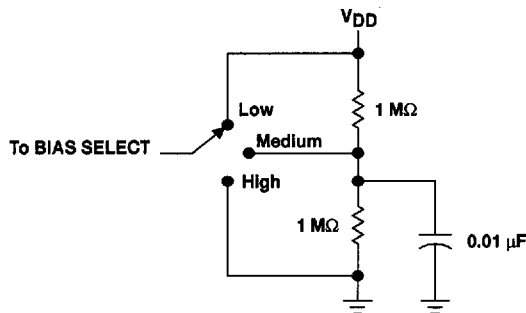

BIAS MODE	BIAS-SELECT VOLTAGE (single supply)
Low	V_{DD}
Medium	1 V to $V_{DD} - 1$ V
High	GND

Figure 106. Bias Selection for Single-Supply Applications

input characteristics

The TLC271 is specified with a minimum and a maximum input voltage that, if exceeded at either input, could cause the device to malfunction. Exceeding this specified range is a common problem, especially in single-supply operation. Note that the lower range limit includes the negative rail, while the upper range limit is specified at $V_{DD} - 1$ V at $T_A = 25^\circ\text{C}$ and at $V_{DD} - 1.5$ V at all other temperatures.

The use of the polysilicon-gate process and the careful input circuit design gives the TLC271 very good input offset voltage drift characteristics relative to conventional metal-gate processes. Offset voltage drift in CMOS devices is highly influenced by threshold voltage shifts caused by polarization of the phosphorus dopant implanted in the oxide. Placing the phosphorus dopant in a conductor (such as a polysilicon gate) alleviates the polarization problem, thus reducing threshold voltage shifts by more than an order of magnitude. The offset voltage drift with time has been calculated to be typically 0.1 $\mu\text{V}/\text{month}$, including the first month of operation.

Because of the extremely high input impedance and resulting low bias current requirements, the TLC271 is well suited for low-level signal processing; however, leakage currents on printed circuit boards and sockets can easily exceed bias current requirements and cause a degradation in device performance. It is good practice to include guard rings around inputs (similar to those of Figure 101 in the Parameter Measurement Information section). These guards should be driven from a low-impedance source at the same voltage level as the common-mode input (see Figure 107).

The inputs of any unused amplifiers should be tied to ground to avoid possible oscillation.

noise performance

The noise specifications in operational amplifier circuits are greatly dependent on the current in the first-stage differential amplifier. The low input bias current requirements of the TLC271 results in a very low noise current, which is insignificant in most applications. This feature makes the devices especially favorable over bipolar devices when using values of circuit impedance greater than 50 $\text{k}\Omega$, since bipolar devices exhibit greater noise currents.

APPLICATION INFORMATION

noise performance (continued)

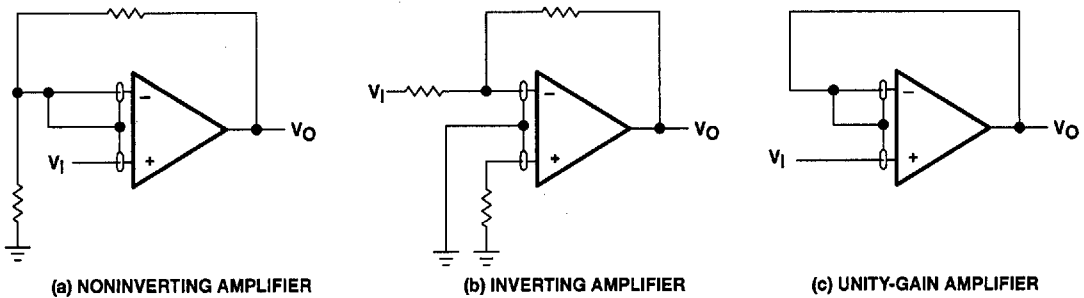

Figure 107. Guard-Ring Schemes

feedback

Operational amplifier circuits almost always employ feedback, and since feedback is the first prerequisite for oscillation, a little caution is appropriate. Most oscillation problems result from driving capacitive loads and ignoring stray input capacitance. A small-value capacitor connected in parallel with the feedback resistor is an effective remedy (see Figure 108). The value of this capacitor is optimized empirically.

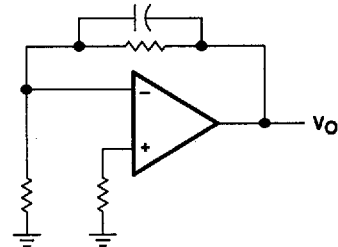

Figure 108. Compensation for Input Capacitance

electrostatic discharge protection

The TLC271 incorporates an internal electrostatic-discharge (ESD) protection circuit that prevents functional failures at voltages up to 2000 V as tested under MIL-STD-883C, Method 3015.2. Care should be exercised, however, when handling these devices as exposure to ESD may result in the degradation of the device parametric performance. The protection circuit also causes the input bias currents to be temperature dependent and have the characteristics of a reverse-biased diode.

latch-up

Because CMOS devices are susceptible to latch-up due to their inherent parasitic thyristors, the TLC271 inputs and output were designed to withstand -100-mA surge currents without sustaining latchup; however, techniques should be used to reduce the chance of latch-up whenever possible. Internal protection diodes should not by design be forward biased. Applied input and output voltage should not exceed the supply voltage by more than 300 mV. Care should be exercised when using capacitive coupling on pulse generators. Supply transients should be shunted by the use of decoupling capacitors ($0.1\ \mu\text{F}$ typical) located across the supply rails as close to the device as possible.

The current path established if latch-up occurs is usually between the positive supply rail and ground and can be triggered by surges on the supply lines and/or voltages on either the output or inputs that exceed the supply voltage. Once latch-up occurs, the current flow is limited only by the impedance of the power supply and the forward resistance of the parasitic thyristor and usually results in the destruction of the device. The chance of latch-up occurring increases with increasing temperature and supply voltages.

APPLICATION INFORMATION

output characteristics

The output stage of the TLC271 is designed to sink and source relatively high amounts of current (see Typical Characteristics). If the output is subjected to a short-circuit condition, this high current capability can cause device damage under certain conditions. Output current capability increases with supply voltage.

All operating characteristics of the TLC271 were measured using a 20-pF load. The devices drive higher capacitive loads; however, as output load capacitance increases, the resulting response pole occurs at lower frequencies, thereby causing ringing, peaking, or even oscillation (see Figures 110, 111, and 112). In many cases, adding some compensation in the form of a series resistor in the feedback loop alleviates the problem.

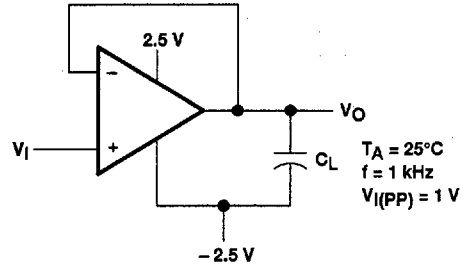

Figure 109. Test Circuit for Output Characteristics

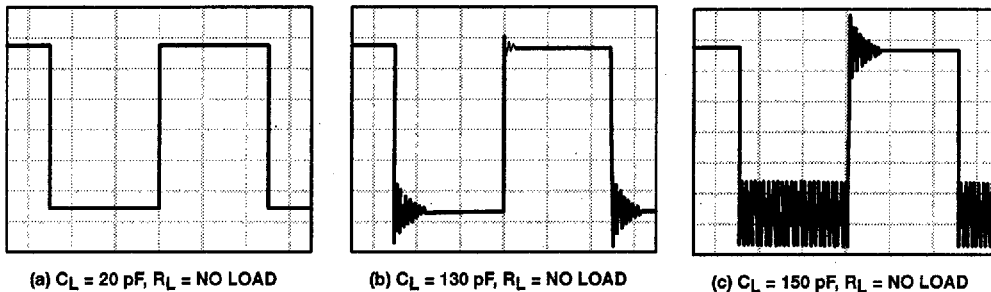

Figure 110. Effect of Capacitive Loads in High-Bias Mode

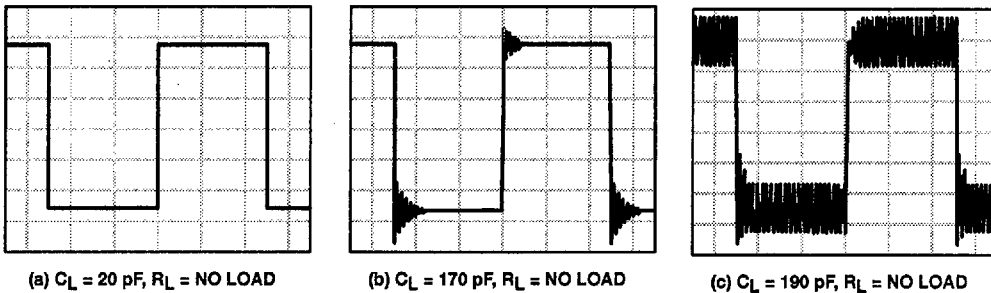

Figure 111. Effect of Capacitive Loads in Medium-Bias Mode

APPLICATION INFORMATION

output characteristics (continued)

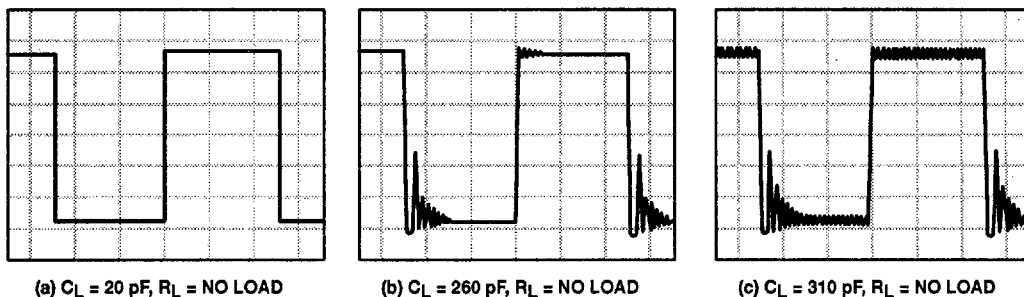

Figure 112. Effect of Capacitive Loads in Low-Bias Mode

Although the TLC271 possesses excellent high-level output voltage and current capability, methods are available for boosting this capability, if needed. The simplest method involves the use of a pullup resistor (R_P) connected from the output to the positive supply rail (see Figure 113). There are two disadvantages to the use of this circuit. First, the NMOS pulldown transistor, N4 (see equivalent schematic) must sink a comparatively large amount of current. In this circuit, N4 behaves like a linear resistor with an on-resistance between approximately 60Ω and 180Ω , depending on how hard the operational amplifier input is driven. With very low values of R_P , a voltage offset from 0 V at the output occurs. Secondly, pullup resistor R_P acts as a drain load to N4 and the gain of the operational amplifier is reduced at output voltage levels where N5 is not supplying the output current.

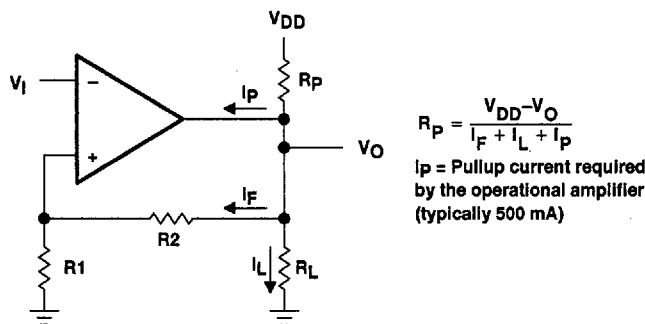
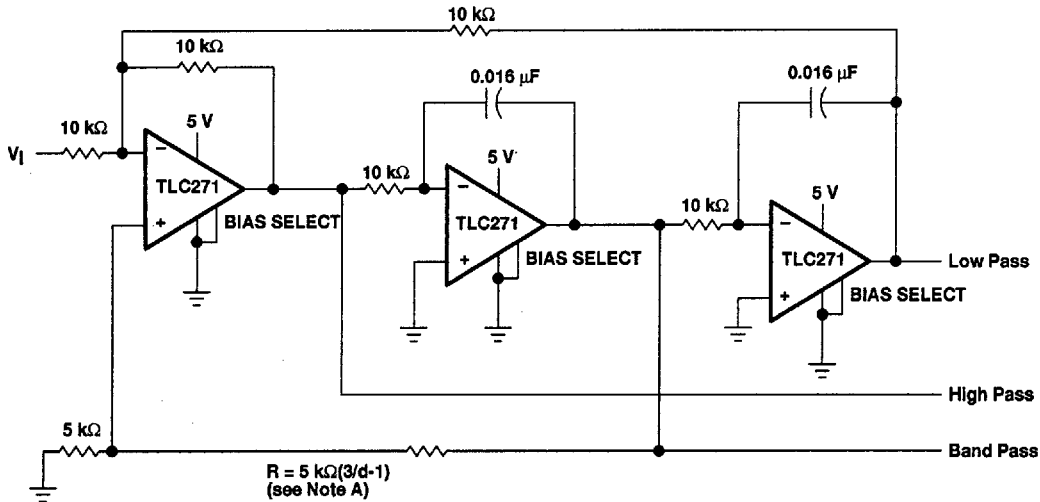

Figure 113. Resistive Pullup to Increase V_{OH}

APPLICATION INFORMATION

output characteristics (continued)



NOTE A: d = damping factor, I/O

Figure 114. State-Variable Filter

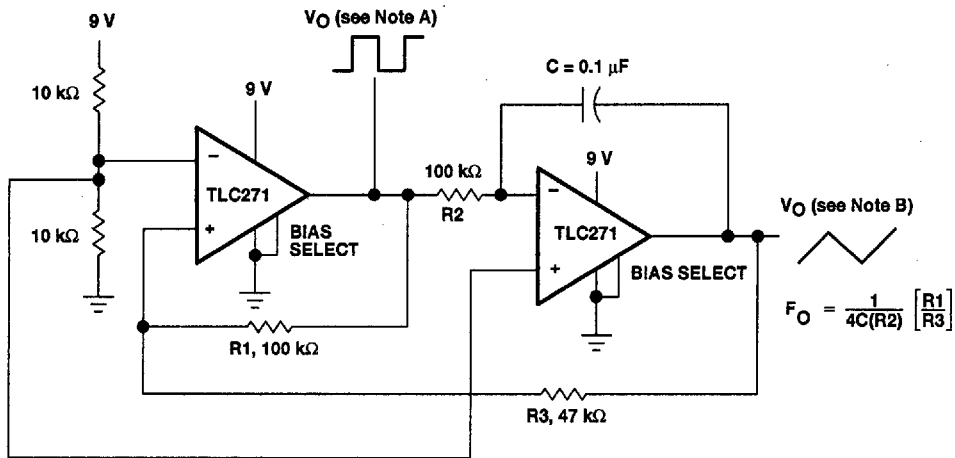

NOTES: A. $V_{O(PP)} = 8\text{ V}$
 B. $V_{O(PP)} = 4\text{ V}$

Figure 115. Single-Supply Function Generator

APPLICATION INFORMATION (HIGH-BIAS MODE)

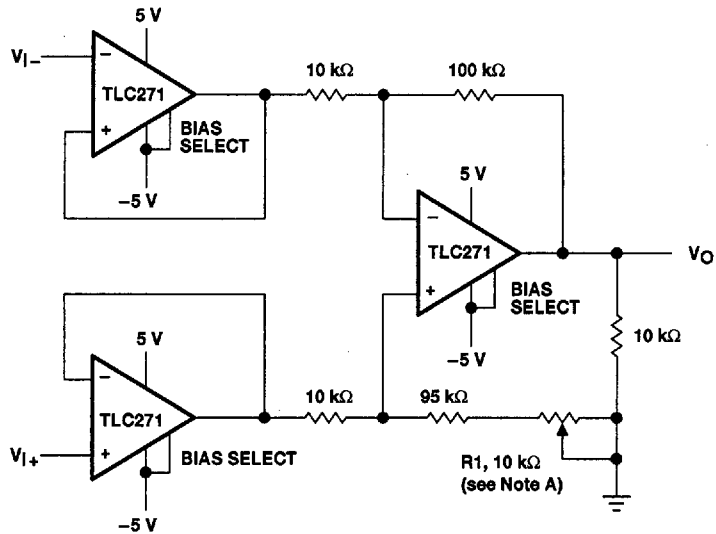

NOTE A: CMRR adjustment must be noninductive.

Figure 116. Low-Power Instrumentation Amplifier

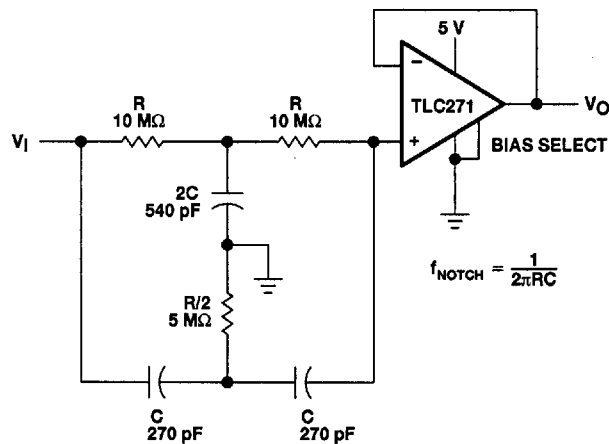

$$f_{\text{NOTCH}} = \frac{1}{2\pi RC}$$

Figure 117. Single-Supply Twin-T Notch Filter

TLC271, TLC271A, TLC271B
LinCMOS™ PROGRAMMABLE LOW-POWER
OPERATIONAL AMPLIFIERS

SLOS090A—NOVEMBER 1987—REVISED AUGUST 1994

APPLICATION INFORMATION (HIGH-BIAS MODE)

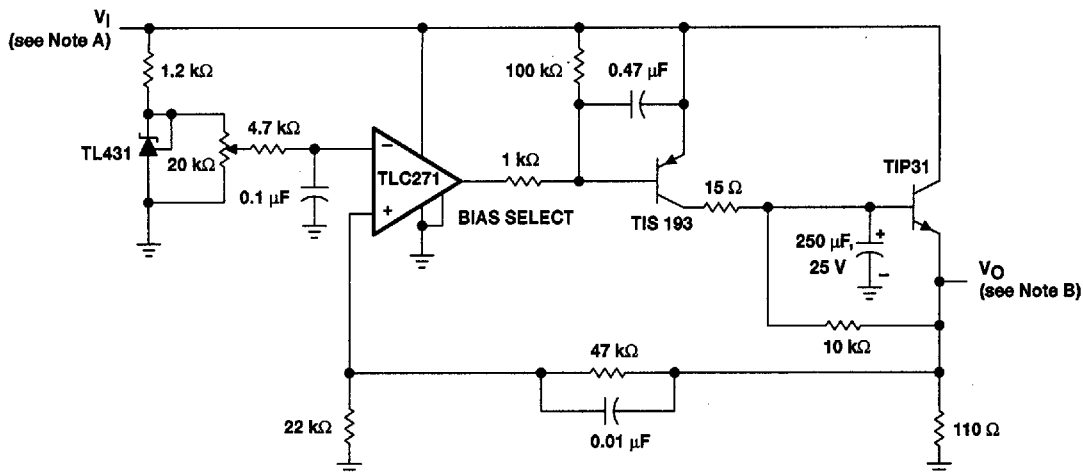

NOTES: C. $V_I = 3.5$ to 15 V
 D. $V_O = 2.0$ V, 0 to 1 A

Figure 118. Logic-Array Power Supply

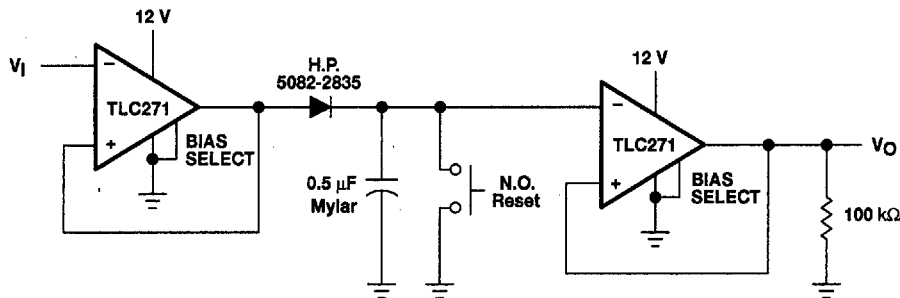
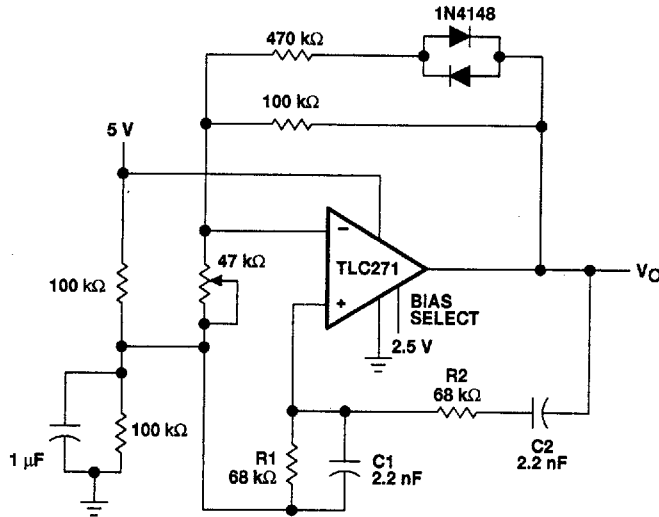

Figure 119. Positive-Peak Detector

APPLICATION INFORMATION (MEDIUM-BIAS MODE)



NOTES: $V_{O(PP)} = 2 V$

$$f_o = \frac{1}{2\pi \sqrt{R_1 R_2 C_1 C_2}}$$

Figure 120. Wein Oscillator

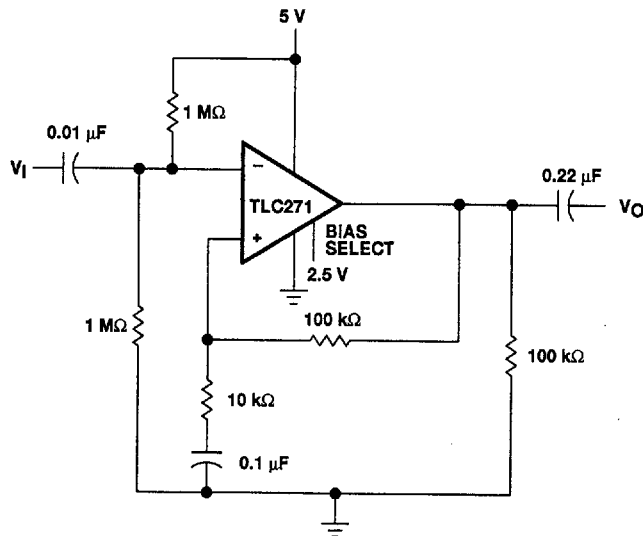
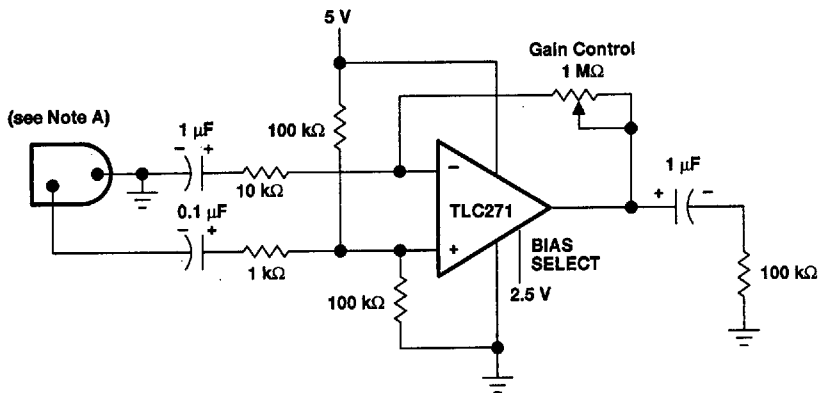

Figure 121. Single-Supply AC Amplifier

TLC271, TLC271A, TLC271B
LinCMOS™ PROGRAMMABLE LOW-POWER
OPERATIONAL AMPLIFIERS

SLOS090A – NOVEMBER 1987 – REVISED AUGUST 1994

APPLICATION INFORMATION (MEDIUM-BIAS MODE)



NOTE A: Low to medium impedance dynamic mike

Figure 122. Microphone Preamplifier

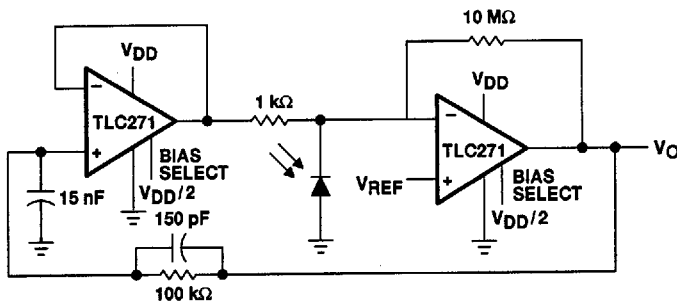

NOTES: $V_{DD} = 4 \text{ V to } 15 \text{ V}$
 $V_{ref} = 0 \text{ V to } V_{DD} - 2 \text{ V}$

Figure 123. Photo-Diode Amplifier With Ambient Light Rejection

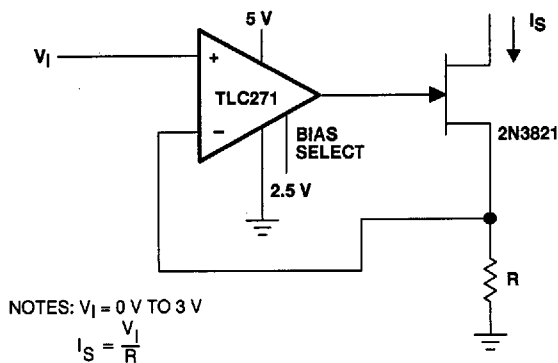

NOTES: $V_I = 0 \text{ V to } 3 \text{ V}$
 $I_S = \frac{V_I}{R}$

Figure 124. Precision Low-Current Sink

APPLICATION INFORMATION (LOW-BIAS MODE)

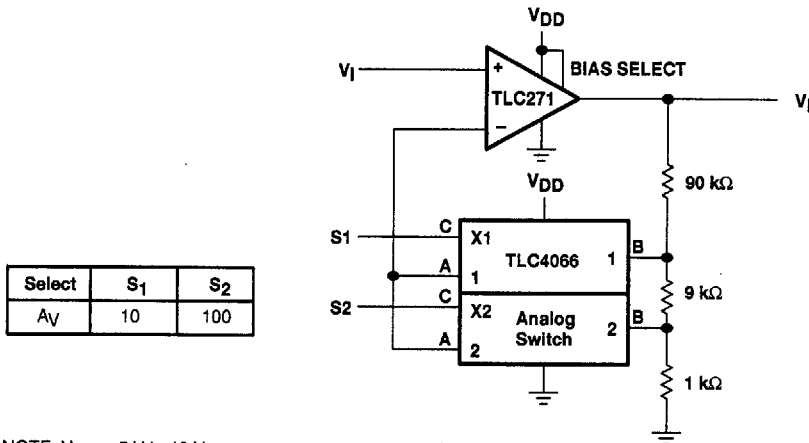

NOTE: V_{DD} = 5 V to 12 V

Figure 125. Amplifier With Digital Gain Selection

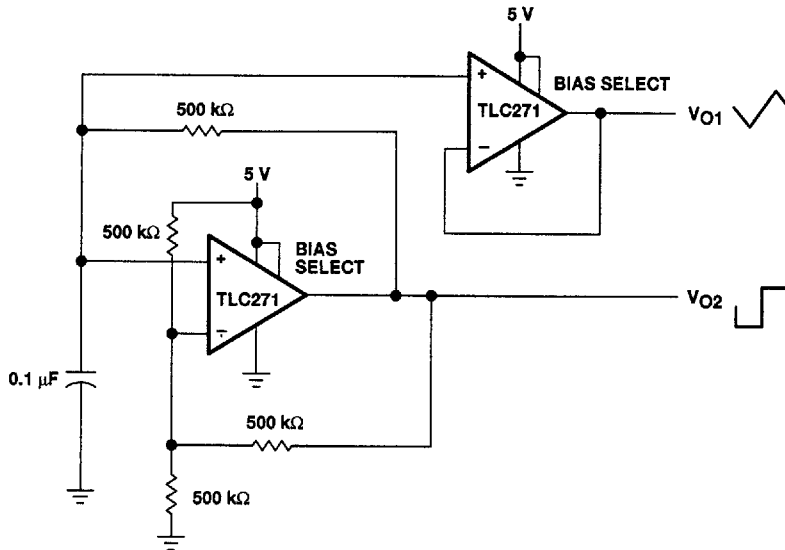
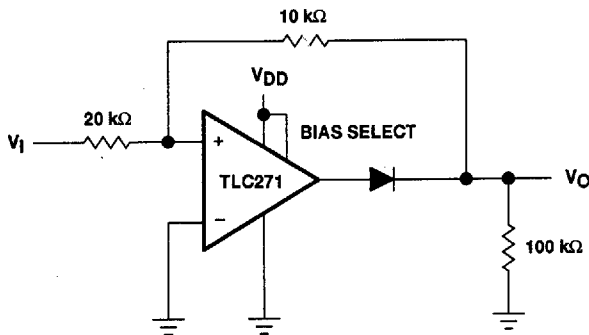

Figure 126. Multivibrator

TLC271, TLC271A, TLC271B
LinCMOS™ PROGRAMMABLE LOW-POWER
OPERATIONAL AMPLIFIERS

SLOS090A - NOVEMBER 1987 - REVISED AUGUST 1994

APPLICATION INFORMATION (LOW-BIAS MODE)



NOTE: $V_{DD} = 5\text{ V to }16\text{ V}$

Figure 127. Full-Wave Rectifier

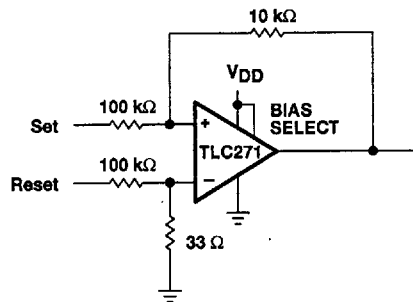

NOTE: $V_{DD} = 5\text{ V to }16\text{ V}$

Figure 128. Set/Reset Flip-Flop

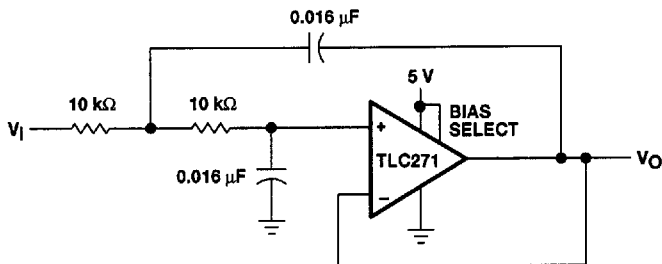

NOTE: Normalized to $F_C = 1\text{ kHz}$ and $R_L = 10\text{ k}\Omega$

Figure 129. Two-Pole Low-Pass Butterworth Filter