

Z8031/Z8531

Asynchronous Serial Communications Controller (ASCC)

Z8031/Z8531

DISTINCTIVE CHARACTERISTICS

- **Two 0 to 2Mbps full duplex serial channels -**
Each channel has independent oscillator, band-rate generator, and PLL for clock recovery, dramatically reducing the need for external components.
- **Programmable protocols -**
NRZ, NRZI, and FM data encoding supported under program control.
- **Programmable Asynchronous Modes -**
5 to 8 bit characters with programmable stop bits, clock break detect, and error conditions.
- **Z8000* compatible -**
The Z8031 interfaces directly to the Z8000 CPU bus and to the Z8000 interrupt structure.
- **Compatible with non-multiplexed bus -**
The Z8531 interfaces easily to most other CPUs.

GENERAL DESCRIPTION

Asynchronous Serial Communications Controllers are dual-channel communications peripherals designed for use with 8- and 16-bit microprocessors. They function as serial-to-parallel, and parallel-to-serial converter/controllers, and contain a variety of new, sophisticated internal functions, including on-chip baud rate generators, digital phase-locked loops and crystal oscillators, to dramatically reduce the need for external circuitry.

Both channels have facilities for modem control; in cases where these controls aren't needed, they can be used for general purpose I/O.

The Z8031 is directly compatible with the Z8000 and 8086 CPUs, while the Z8531 is designed for non-multiplexed buses, and is easily interfaced with most other CPUs such as 8080, Z80, 6800, 68000 and MULTIBUS.**

BLOCK DIAGRAM

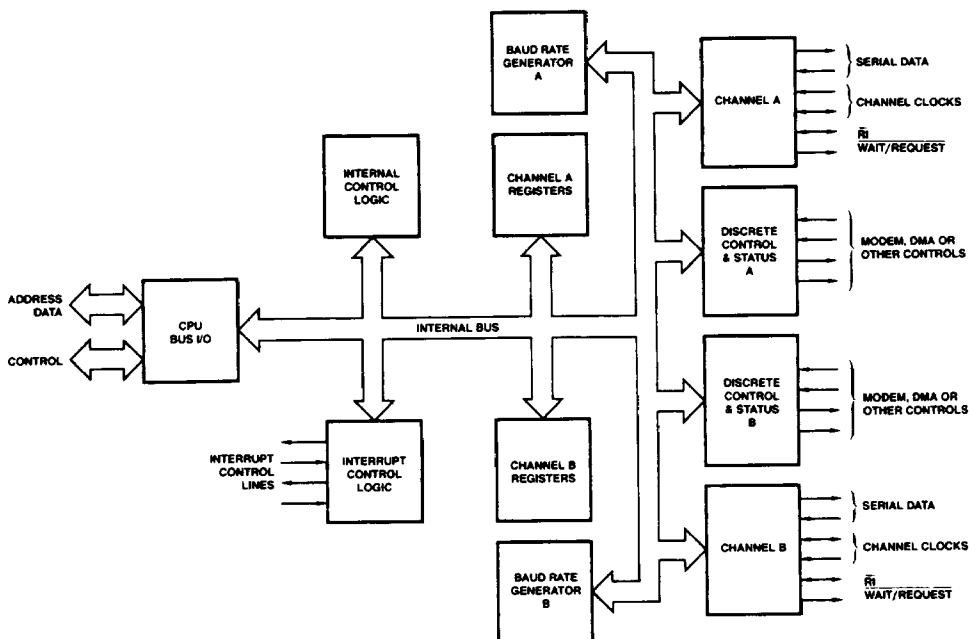

BD003260

Figure 1.

*Z8000 is a trademark of Zilog, Inc.
**MULTIBUS is a trademark of Intel Corporation.

RELATED AMD PRODUCTS

Part No.	Description
Am79C12	212A Modem (1200BPS)
Am7960	Coded Data Transceiver
Am80186	Highly Integrated 16-Bit Microprocessor
Am80286	High Performance 16-Bit Microprocessor
Am8080A	8-Bit Microprocessor
Am9517A	DMA Controller

CONNECTION DIAGRAMS

Top View
DIPs

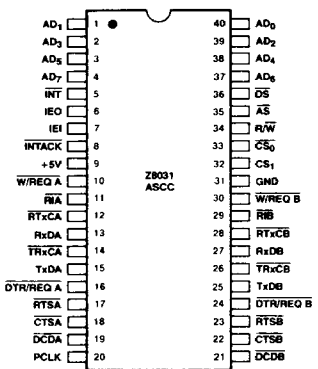

CD005080

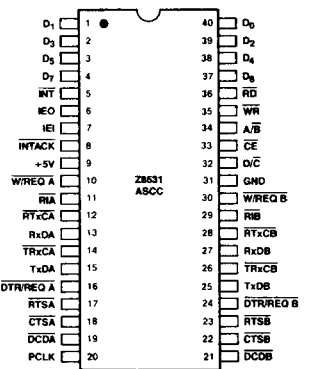

CD005090

Note: Pin 1 is marked for orientation.

LOGIC SYMBOLS

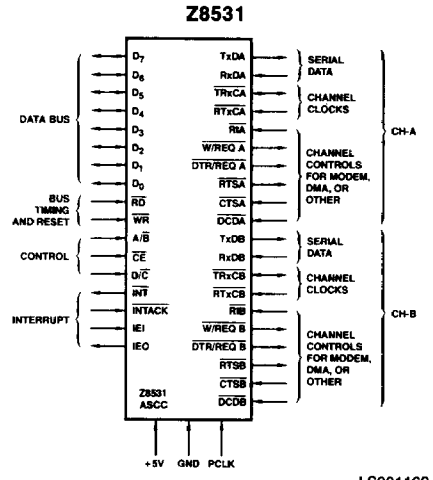
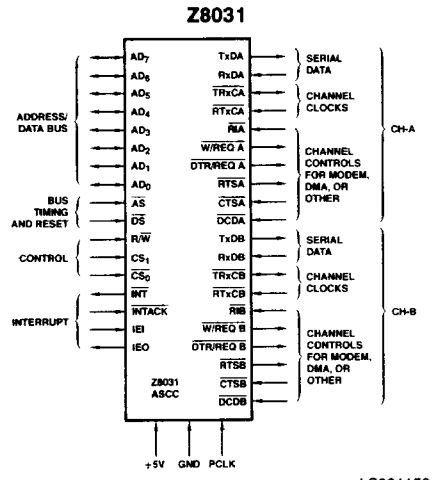

ORDERING INFORMATION

Commodity Products

AMD commodity products are available in several packages and operating ranges. The order number (Valid Combination) is formed by a combination of:

- A. Device Number**
- B. Speed Option**
- C. Package Type**
- D. Temperature Range**
- E. Optional Processing**

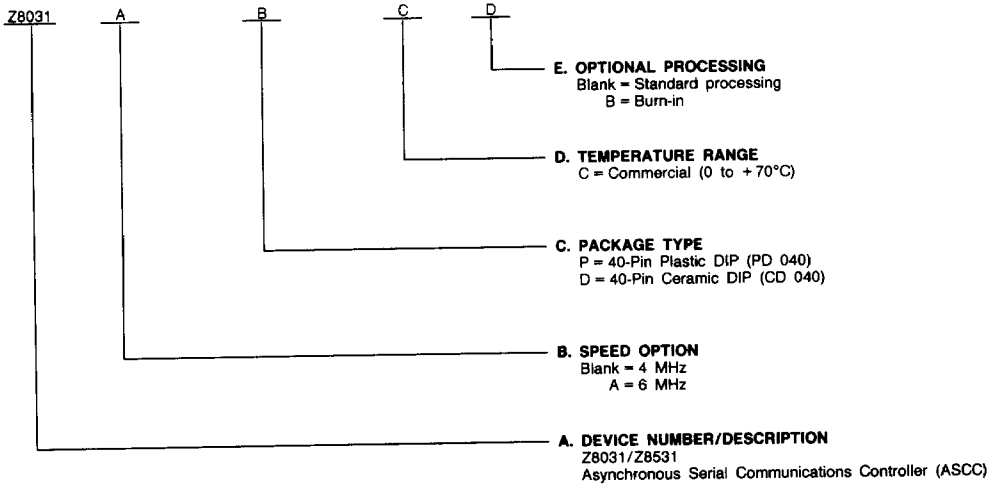

Valid Combinations	
Z8031	PC, DC, DCB
Z8031A	
Z8531	
Z8531A	

Valid Combinations

Valid Combinations list configurations planned to be supported in volume for this device. Consult the local AMD sales office to confirm availability of specific valid combinations, to check on newly released valid combinations, and to obtain additional data on AMD's standard military grade products.

PIN DESCRIPTION

Z8031

Pin No.	Name	I/O	Description
9	V _{CC}		+ 5V Power Supply
31	GND		Ground
1-4, 37-40	AD ₀ – AD ₇	I/O	Address/Data Bus (bidirectional, active High, three-state). These multiplexed lines carry register addresses to the ASCC as well as data or control information to and from the ASCC.
35	AS	I	Address Strobe (active Low). Addresses on AD ₀ – AD ₇ are latched by the rising edge of this signal.
33	CS ₀	I	Chip Select 0 (active Low). This signal is latched concurrently with the addresses on AD ₀ – AD ₇ and must be active for the intended bus transaction to occur.
32	CS ₁	I	Chip Select 1 (active High). This second select signal must also be active before the intended bus transaction can occur. CS ₁ must remain active throughout the transaction.
18, 22	CTSA, CTSB	I	Clear to Send (active Low). If these pins are programmed as Auto Enables, a Low on these inputs enables their respective transmitter. If not programmed as Auto Enables, they may be used as general-purpose inputs. Both inputs are Schmitt-trigger buffered to accommodate slow rise-time inputs. The ASCC detects pulses on these inputs and can interrupt the CPU on both logic level transitions.
19, 21	DCDA, DCDB	I	Data Carrier Detect (active Low). These pins function as receiver enables if they are programmed for Auto Enables; otherwise they may be used as general-purpose inputs pins. Both pins are Schmitt-trigger buffered to accommodate slow rise-time signals. The ASCC detects pulses on these pins and can interrupt the CPU on both logic level transitions.
36	DS	I	Data Strobe (active Low). This signal provides timing for the transfer of data into and out of the ASCC. If AS and DS coincide, this is interpreted as a reset.
16, 24	DTR/REQA, DTR/REQB	O	Data Terminal Ready/Request (active Low). These outputs follow the state programmed into the DTR bit. They can also be used as general-purpose outputs or as Request Lines for a DMA controller.
7	IEI	I	Interrupt Enable In (active High). IEI is used with IEO to form an interrupt daisy chain when there is more than one interrupt-driven device. A High IEI indicates that no other higher priority device has an interrupt under service or is requesting an interrupt.
6	IEO	O	Interrupt Enable Out (active High). IEO is High only if IEI is High and the CPU is not servicing an ASCC interrupt or the ASCC is not requesting an interrupt (interrupt acknowledge cycle only). IEO is connected to the next lower priority device's IEI input and thus inhibits interrupts from lower priority devices.
5	INT	O	Interrupt Request (open-drain, active Low). This signal is activated when the ASCC requests an interrupt.
8	INTACK	I	Interrupt Acknowledge (active Low). This signal indicates an active interrupt acknowledge cycle. During this cycle, the ASCC interrupt daisy chain settles. When DS becomes active, the ASCC places an interrupt vector on the data bus (if IEI is High). INTACK is latched by the rising edge of AS.
20	PCLK	I	Clock. This is the master ASCC clock used to synchronize internal signals. PCLK is not required to have any phase relationship with the master system clock, although the frequency of this clock must be at least 90% of the CPU clock frequency for a Z8000. PCLK is a TTL level signal.
13, 27	RxDA, RxDB	I	Receive Data (active High). These input signals receive serial data at standard TTL levels.
12, 28	RTxCA, RTxCB	I	Receive/Transmit Clocks (active Low). These pins can be programmed in several different modes of operation. In each channel, RTxC may supply the receive clock, the transmit clock, the clock for the baud rate generator, or the clock of the digital phase-locked loop. These pins can also be programmed for use with the respective RI pins as a crystal oscillator. The receive clock may be 1, 16, 32, or 64 times the data rate in asynchronous modes.
17, 23	RTSA, RTSB	O	Request to Send (active Low). When the Request to Send (RTS) bit in Write Register 5 (Figure 7) is set, the RTS signal goes Low. When the RTS bit is reset and Auto Enable is on, the signal goes High after the transmitter is empty. With Auto Enable off, the RTS pin strictly follows the state of the RTS bit. Both pins can be used as general-purpose outputs.
34	R/W	I	Read/Write. This signal specifies whether the operation to be performed is read or a write.
11, 29	RIA, RIB	I	Ring Indicator (active Low). These pins can act either as inputs or as part of the crystal oscillator circuit. In normal operation (crystal oscillator option not selected), these pins are inputs similar to CTS and DCD. In this mode, transitions on these lines affect the state of the Ring Indicator status bits in Read Register 0 (Figure 6) but have no other function.
15, 25	TxDA, TxDB	O	Transmit/Receive Clocks (active Low). These output signals transmit serial data at standard TTL levels.
14, 26	TRxCA, TRxCB	I	Transmit/Receive Clocks (active Low). These pins can be programmed in several different modes of operation. TRxC may supply the receive clock or the transmit clock in the input mode or supply the output of the digital phase-locked loop, the crystal oscillator, the baud rate generator, or the transmit clock in the output mode.
10, 30	W/REQA, W/REQB	O	Wait/Request (open-drain when programmed for a Wait function, driven High or Low when programmed for a Request function). These dual-purpose outputs may be programmed as Request lines for a DMA controller or as Wait lines to synchronize the CPU to the ASCC data rate. The reset state is Wait.

Z8031/Z8531

5

PIN DESCRIPTION (Cont'd.)

Z8531

Pin No.	Name	I/O	Description
9	V _{CC}		+ 5V Power Supply
31	GND		Ground
34	A/B	I	Channel A/Channel B Select. This signal selects the channel in which the read or write operation occurs.
33	\overline{CE}	I	Chip Enable (active Low). This signals selects the ASCC for a read or write operation.
18, 22	$\overline{CTS_A}$, $\overline{CTS_B}$	I	Clear to Send (active Low). If these pins are programmed as Auto Enables, a Low on the inputs enables the respective transmitters. If not programmed as Auto Enables, they may be used as general-purpose inputs. Both inputs are Schmitt-trigger buffered to accommodate slow rise-time inputs. The ASCC detects pulses on these inputs and can interrupt the CPU on both logic level transitions.
32	D/ \overline{C}	I	Data/Control Select. This signal defines the type of information transferred to or from the ASCC. A High means data is transferred; a Low indicates a command.
19, 21	\overline{DCDA} , \overline{DCDB}	I	Data Carrier Detect (active Low). These pins function as receiver enables if they are programmed for Auto Enables; otherwise they may be used as general-purpose inputs pins. Both pins are Schmitt-trigger buffered to accommodate slow rise-time signals. The ASCC detects pulses on these pins and can interrupt the CPU on both logic level transitions.
1-4, 37-40	D ₀ - D ₇	I/O	Data Bus (bidirectional, three-state). These lines carry data and commands to and from the ASCC.
16, 24	$\overline{DTR/REQA}$, $\overline{DTR/REQB}$	O	Data Terminal Ready/Request (active Low). These outputs follow the state programmed into the DTR bit. They can also be used as general-purpose outputs or as Request Lines for a DMA controller.
7	IEI	I	Interrupt Enable In (active High). IEI is used with IEO to form an interrupt daisy chain when there is more than one interrupt-driven device. A High IEI indicates that no other higher priority device has an interrupt under service or is requesting an interrupt.
6	IEO	O	Interrupt Enable Out (active High). IEO is High only if IEI is High and the CPU is not servicing an ASCC interrupt or the ASCC is not requesting an interrupt (interrupt acknowledge cycle only). IEO is connected to the next lower priority device's IEI input and thus inhibits interrupts from lower priority devices.
5	INT	O	Interrupt Request (open-drain, active Low). This signal is activated when the ASCC requests an interrupt.
8	INTACK	I	Interrupt Acknowledge (active Low). This signal indicates an active interrupt acknowledge cycle. During this cycle, the ASCC interrupt daisy chain settles. When RD becomes active, the ASCC places an interrupt vector on the data bus (if IEI is High). INTACK is latched by the rising edge of PCLK.
20	PCLK	I	Clock. This is the master ASCC clock used to synchronize internal signals. PCLK is a TTL level signal.
36	RD	I	Read (active Low). This signal indicates a read operation and when the ASCC is selected, enables the ASCC's bus drivers. During the interrupt acknowledge cycle, this signal gates the interrupt vector onto the bus if the ASCC is the highest priority device requesting an interrupt.
13, 27	RxDA, RxDB	I	Receive Data (active High). These input signals receive serial data at standard TTL levels.
12, 28	RTxCA, RTxCB	I	Receive/Transmit Clocks (active Low). These pins can be programmed in several different modes of operation. In each channel RTxC may supply the receive clock, the transmit clock, the clock for the baud rate generator, or the clock of the digital phase-locked loop. These pins can also be programmed for use with the respective RI pins as a crystal oscillator. The receive clock may be 1, 16, 32, or 64 times the data rate in asynchronous modes.
17, 23	RTSA, RTSB	O	Request to Send (active Low). When the Request to Send (RTS) bit in Write Register 5 (Figure 7) is set, the RTS signal goes Low. When the RTS bit is reset in the asynchronous mode and Auto Enable is on, the signal goes High after the transmitter is empty. With Auto Enable off, the RTS pin strictly follows the state of the RTS bit. Both pins can be used as general-purpose outputs.
15, 25	TxDA, TxDB	O	Transmit Data (active High). These output signals transmit serial data at standard TTL levels.
14, 26	TRxCA, TRxCB	I/O	Transmit/Receive Clocks (active Low). These pins can be programmed in several different modes of operation. TRxC may supply the receive clock or the transmit clock in the input mode or supply the output of the digital phase-locked loop, the crystal oscillator, the baud rate generator, or the transmit clock in the output mode.
35	WR	I	Write (active Low). When the ASCC is selected, this signal indicates a write operation. The coincidence of RD and WR is interpreted as a reset.
10, 30	$\overline{W/REQA}$, $\overline{W/REQB}$	O	Wait/Request (open-drain when programmed for a Wait function, driven High or Low when programmed for a Request function). These dual-purpose outputs may be programmed as Request lines for a DMA controller or as Wait lines to synchronize the CPU to the ASCC data rate. The reset state is Wait.

ARCHITECTURE

The ASCC internal structure includes two full-duplex channels, two baud rate generators, internal control and interrupt logic, and a bus interface to the Z8000 CPU (Z8031) or to a non-multiplexed CPU bus (Z8531). Associated with each channel are a number of read and write registers for mode control and status information, as well as logic necessary to interface to modems or other external devices (Figure 1).

The logic for both channels provides formats, synchronization, and validation for data transferred to and from the channel interface. The modem control inputs are monitored by the control logic under program control. All of the modem control signals are general-purpose in nature and can optionally be used for functions other than modem control.

The register set for each channel includes ten control (write) registers, two synchronous character (write) registers, and four status (read) registers. In addition, each baud rate generator has two (read/write) registers for holding the time constant that determines the baud rate. Finally, associated with the interrupt logic is a write register for the interrupt vector accessible through either channel, a write-only Master Interrupt Control register and three read registers: one containing the vector with status information (Channel B only), one containing the vector without status (A only), and one containing the Interrupt Pending bits (A only).

The registers for each channel are designated as follows: WR0-WR15 - Write Registers 0 through 15. RR0-RR3, RR10, RR12, RR13, RR15 - Read Registers 0 through 3, 10, 12, 13, 15.

The following table lists the functions assigned to each read or write register. The ASCC contains only one WR2 and WR9, but they can be accessed by either channel. All other registers are paired (one for each channel).

DATA PATH

The transmit and receive data path illustrated in Figure 2 is identical for both channels. The receiver has three 8-bit buffer registers in a FIFO arrangement, in addition to the 8-bit receive shift register. This scheme creates additional time for the CPU to service an interrupt at the beginning of a block of high-speed data. Incoming data is routed through one of several paths (data or CRC) depending on the selected mode (the character length in asynchronous modes also determines the data path).

The transmitter has an 8-bit transmit data buffer register loaded from the internal data bus and an 11-bit transmit shift register that can be loaded from the transmit data register. Depending on the operational mode, outgoing data is routed through one of four main paths before it is transmitted from the Transmit Data output (TxD).

TABLE 1. READ AND WRITE REGISTER FUNCTIONS

READ REGISTER FUNCTIONS	WRITE REGISTER FUNCTIONS
RR0 Transmit/Receive buffer status and External status	WR0 CRC initialize, initialization commands for the various modes, shift right/shift left command
RR1 Special Receive Condition status	WR1 Transmit/Receive interrupt and data transfer mode definition
RR2 Modified interrupt vector (Channel B only) Unmodified interrupt vector (Channel A only)	WR2 Interrupt vector (accessed through either channel)
RR3 Interrupt Pending bits (Channel A only)	WR3 Receive parameters and control
RR8 Receive buffer	WR4 Transmit/Receive miscellaneous parameters and modes
RR10 Miscellaneous status	WR5 Transmit parameters and controls
RR12 Lower byte of baud rate generator time constant	WR6 Sync characters or SDLC address field
RR13 Upper byte of baud rate generator time constant	WR7 Sync character or SDLC flag
RR15 External/Status interrupt information	WR8 Transmit buffer
	WR9 Master interrupt control and reset (accessed through either channel)
	WR10 Miscellaneous transmitter/receiver control bits
	WR11 Clock mode control
	WR12 Lower byte of baud rate generator time constant
	WR13 Upper byte of baud rate generator time constant
	WR14 Miscellaneous control bits
	WR15 External/Status interrupt control

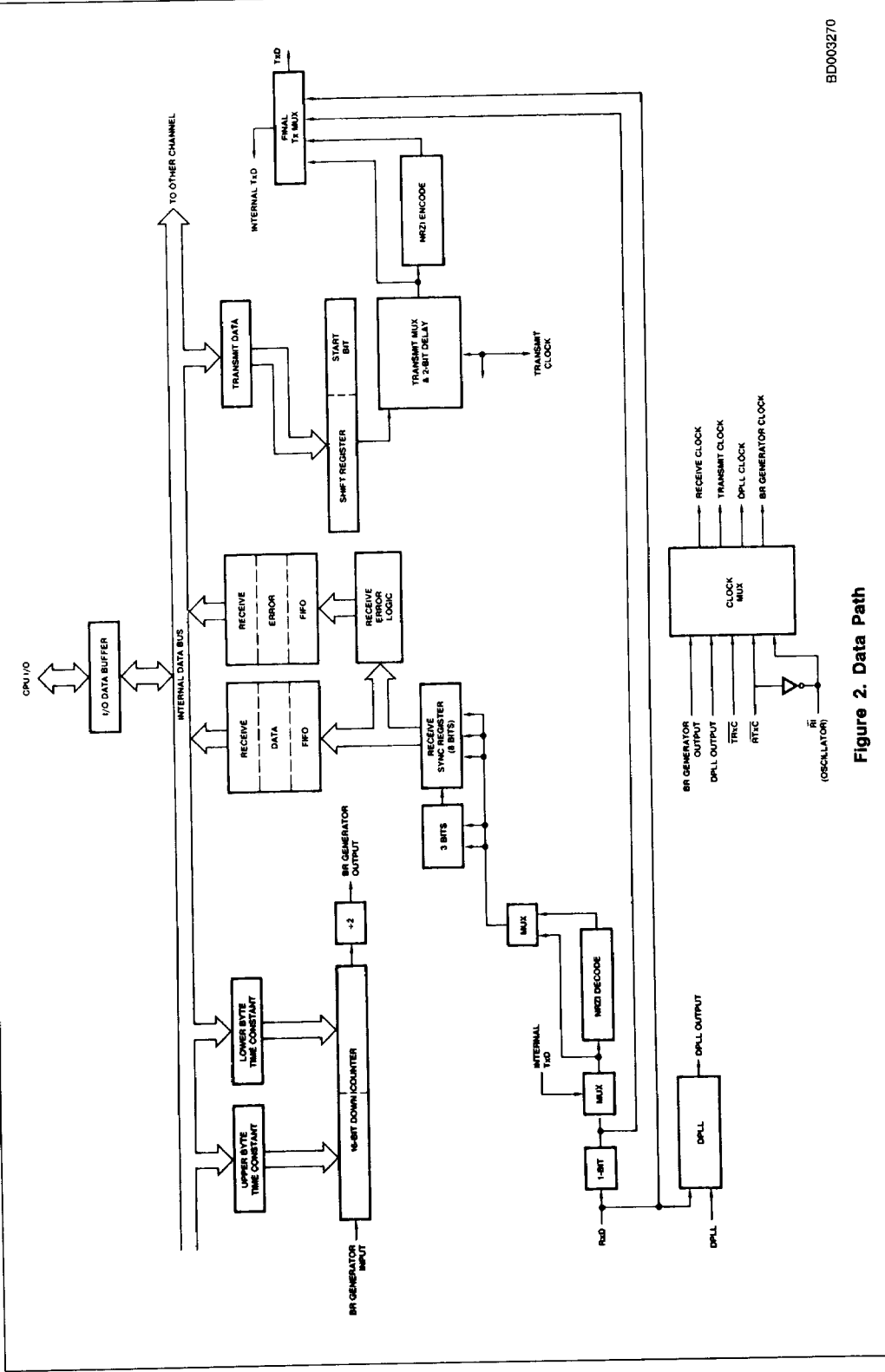

Figure 2. Data Path

DETAILED DESCRIPTION

The functional capabilities of the SCC can be described from two different points of view: as a data communications device, it transmits and receives data in a wide variety of data communications protocols; as a microprocessor peripheral, it interacts with the CPU and provides vectored interrupts and handshaking signals.

DATA COMMUNICATIONS CAPABILITIES

The ASCC provides two independent full-duplex channels programmable for use in any common asynchronous data-communication protocol. Figure 3 and the following description briefly detail this protocol.

Asynchronous Modes

Transmission and reception can be accomplished independently on each channel with five to eight bits per character, plus optional even or odd parity. The transmitters can supply one, one-and-a-half or two stop bits per character and can provide a break output at any time. The receiver break-detection logic interrupts the CPU both at the start and at the end of a received break. Reception is protected from spikes by a transient spike-rejection mechanism that checks the signal one-half a bit time after a Low level is detected on the receive data input (RxDA or RxDB in Figure 14). If the Low does not persist (as in the case of a transient), the character assembly process does not start.

Framing errors and overrun errors are detected and buffered together with the partial character on which they occur. Vectored interrupts allow fast servicing of error conditions using dedicated routines. Furthermore, a built-in checking process avoids the interpretation of framing error as a new start bit: a framing error results in the addition of one-half a bit time to the point at which the search for the next start bit begins.

The ASCC does not require symmetric transmit and receive clock signals - a feature allowing use of the wide variety of clock sources. The transmitter and receiver can handle data at a rate of 1, 1/16, 1/32, or 1/64 of the clock rate supplied to the receive and transmit clock inputs.

BAUD RATE GENERATOR

Each channel in the ASCC contains a programmable baud rate generator. Each generator consists of two 8-bit time constant registers that form a 16-bit time constant, a 16-bit down counter, and a flip-flop on the output producing a square wave. On startup, the flip-flop on the output is set in a High state, the value in the time constant register is loaded into the counter, and the counter starts counting down. The output of the baud rate generator toggles upon reaching zero, the value in the time constant register is loaded into the counter, and the process is repeated. The time constant may be changed at any time, but the new value does not take effect until the next load of the counter.

The output of the baud rate generator may be used as either the transmit clock, the receive clock, or both. It can also drive the digital phase-locked loop (see next section).

If the receive clock or transmit clock is not programmed to come from the TRxC pin, the output of the baud rate generator may be echoed out via the TRxC pin.

The following formula relates the time constant to the baud rate. (The baud rate is in bits/second and the BR clock period is in seconds.)

$$\text{baud rate} = \frac{1}{2 (\text{time constant} + 2) \times (\text{BR clock period})}$$

Time-Constant Values for Standard Baud Rates at BR Clock = 3.9936MHz

Rate (Baud)	Time Constant (decimal notation)	Error
19200	102	-
9600	206	-
7200	275	0.12%
4800	414	-
3600	553	0.06%
2400	830	-
2000	996	0.04%
1800	1107	0.03%
1200	1662	-
600	3326	-
300	6654	-
150	13310	-
134.5	14844	0.0007%
110	18151	0.0015%
75	26622	-
50	39934	-

DIGITAL PHASE-LOCKED LOOP

The ASCC contains a digital phase-locked loop (DPLL) to recover clock information from a data stream with NRZI or FM encoding. The DPLL is driven by a clock that is nominally 32 (NRZI) or 16 (FM) times the data rate. The DPLL uses this clock, along with the data stream, to construct a clock for the data. This clock may then be used as the ASCC receive clock, the transmit clock, or both.

For NRZI encoding, the DPLL counts the 32X clock to create nominal bit times. As the 32X clock is counted, the DPLL is searching the incoming data stream for edges (either 1/0 or 0/1). Whenever an edge is detected, the DPLL makes a count adjustment (during the next counting cycle), producing a terminal count closer to the center of the bit cell.

For FM encoding, the DPLL still counts from 0 to 31, but with a cycle corresponding to two bit times. When the DPLL is locked, the clock edges in the data stream should occur between counts 15 and 16 and between counts 31 and 0. The DPLL looks for edges only during a time centered on the 15/16 counting transition.

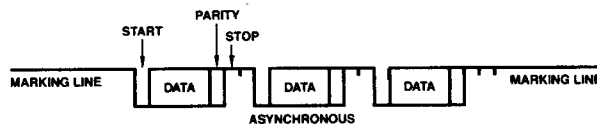

DF001030

Figure 3. ASCC Protocols

The 32X clock for the DPLL can be programmed to come from either the TRxC input or the output of the baud rate generator. The DPLL output may be programmed to be echoed out of the ASCC via the TRxC pin (if this pin is not being used as an input).

DATA ENCODING

The ASCC may be programmed to encode and decode the serial data in four different ways. In NRZ encoding, a 1 is represented by a High level and a 0 is represented by a Low level. In NRZI encoding, a 1 is represented by no change in level and a 0 is represented by a change in level. In FM₁ (more properly, bi-phase mark) a transition occurs at the beginning of every bit cell. A 1 is represented by an additional transition at the center of the bit cell and a 0 is represented by no additional transition at the center of the bit cell. In FM₀ (bi-phase space), a transition occurs at the beginning of every bit cell. A 0 is represented by an additional transition at the center of the bit cell, and a 1 is represented by no additional transition at the center of the bit cell. In addition to these four methods, the ASCC can be used to decode Manchester (bi-phase level) data by using the DPLL in the FM mode and programming the receiver for NRZ data. Manchester encoding always produces a transition at the center of the bit cell. If the transition is 0/1, the bit is a 0. If the transition is 1/0, the bit is a 1.

AUTO ECHO AND LOCAL LOOPBACK

The ASCC is capable of automatically echoing everything it receives. This feature is useful mainly in asynchronous modes, but works in synchronous and SDLC modes as well. In Auto Echo mode, TxD is RxD. Auto Echo mode can be used with NRZI or FM encoding with no additional delay, because the data stream is not decoded before retransmission. In Auto Echo mode, the CTS input is ignored as a transmitter enable (although transitions on this input can still cause interrupts if programmed to do so). In this mode, the transmitter is actually bypassed and the programmer is responsible for disabling transmitter interrupts and WAIT/REQUEST on transmit.

The ASCC is also capable of local loopback. In this mode, TxD is RxD just as in Auto Echo mode. However, in Local Loopback mode, the internal transmit data is tied to the internal receive data and RxD is ignored (except to be echoed

out via TxD). The CTS and DCD inputs are also ignored as transmit and receive enables. However, transitions on these inputs can still cause interrupts. Local Loopback works with NRZ, NRZI or FM coding of the data stream.

I/O INTERFACE CAPABILITIES

The ASCC offers the choice of Polling, Interrupt (vectored or nonvectored), and Block Transfer modes to transfer data, status, and control information to and from the CPU. The Block Transfer mode can be implemented under CPU or DMA control.

POLLING

All interrupts are disabled. Three status registers in the ASCC are automatically updated whenever any function is performed. The idea behind polling is for the CPU to periodically read a status register until the register contents indicate the need for data to be transferred. Only one register needs to be read; depending on its contents, the CPU either writes data, reads data, or continues. Two bits in the register indicate the need for data transfer. An alternative is a poll of the Interrupt Pending register to determine the source of an interrupt. The status for both channels resides in one register.

INTERRUPTS

When an ASCC responds to an Interrupt Acknowledge signal (INTACK) from the CPU, an interrupt vector may be placed on the data bus. This vector is written in WR2 and may be read in RR2A or RR2B (Figures 6 and 7).

To speed interrupt response time, the ASCC can modify three bits in this vector to indicate status. If the vector is read in Channel A, status is never included; if it is read in Channel B, status is always included.

Each of the six sources of interrupts in the ASCC (Transmit, Receive and External/Status interrupts in both channels) has three bits associated with the interrupt source: Interrupt Pending (IP), Interrupt Under Service (IUS), and Interrupt Enable (IE). Operation of the IE bit is straightforward. If the IE bit is set for a given interrupt source, then that source can request interrupts. The exception is when the MIE (Master Interrupt Enable) bit in WR9 is reset and no interrupts may be requested. The IE bits are write-only.

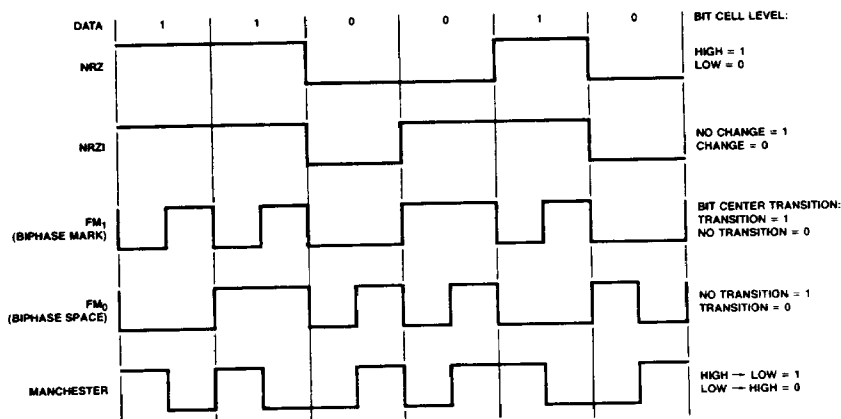

WF003380

Figure 4. Data Encoding Methods

The other two bits are related to the Z-Bus interrupt priority chain (Figure 5). As a Z-Bus peripheral, the ASCC may request an interrupt only when no higher-priority device is requesting one, e.g., when IEI is High. If the device in question requests an interrupt, it pulls down INT. The CPU then responds with INTACK, and the interrupting device places the vector on the A/D bus.

In the ASCC, the IP bit signals a need for interrupt servicing. When an IP bit is 1 and the IEI input is High, the INT output is pulled Low, requesting an interrupt. In the ASCC, if the IE bit is not set by enabling interrupts, then the IP for that source can never be set. The IP bits are readable in RR3A.

The IUS bits signal that an interrupt request is being serviced. If an IUS is set, all interrupt sources of lower priority in the ASCC and external to the ASCC are prevented from requesting interrupts. The internal interrupt sources are inhibited by the state of the internal daisy chain, while lower priority devices are inhibited by the IEO output of the ASCC being pulled Low and propagated to subsequent peripherals. An IUS bit is set during an Interrupt Acknowledge cycle if there are no higher priority devices requesting interrupts.

There are three types of interrupts: Transmit, Receive and External/Status interrupts. Each interrupt type is enabled under program control with Channel A having higher priority than Channel B, and with Receiver, Transmit and External/Status interrupts prioritized in that order within each channel. When the Transmit interrupt is enabled, the CPU is interrupted when the transmit buffer becomes empty. (This implies that the transmitter must have had a data character written into it so that it can become empty.) When enabled, the receiver can interrupt the CPU in one of three ways:

- Interrupt on First Receive Character or Special Receive condition.

- Interrupt on all Receive Characters or Special Receive condition.
- Interrupt on Special Receive condition only.

Interrupt on First Character or Special Condition and Interrupt on Special Condition Only are typically used with the Block Transfer mode. A Special Receive Condition is one of the following: receiver overrun, framing error in asynchronous mode and, optionally, a parity error. The Special Receive Condition interrupt is different from an ordinary receive character available interrupt only in the status placed in the vector during the Interrupt-Acknowledge cycle. In Interrupt on first Receive Character, an interrupt can occur from Special Receive conditions any time after the first receive character interrupt.

The main function of the External/Status interrupt is to monitor the signal transitions of the CTS, DCD, and RI pins; however, an External/Status interrupt is also caused by a Transmit Underrun condition, or a zero count in the baud rate generator, or by the detection of a Break (asynchronous mode).

CPU/DMA BLOCK TRANSFER

The ASCC provides a Block Transfer mode to accommodate CPU block transfer functions and DMA controllers. The Block Transfer mode uses the WAIT/REQUEST output in conjunction with the Wait/Request bits in WR1. The WAIT/REQUEST output can be defined under software control as a WAIT line in the CPU Block Transfer mode or as a REQUEST line in the DMA Block Transfer mode.

To a DMA controller, the ASCC REQUEST output indicates that the ASCC is ready to transfer data to or from memory. To the CPU, the WAIT line indicates that the ASCC is not ready to transfer data, thereby requesting that the CPU extend the I/O cycle. The DTR/REQUEST line allows full-duplex operation under DMA control.

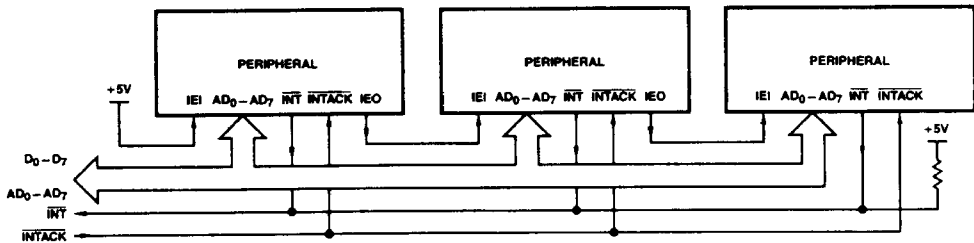

AF002190

Figure 5. Z-Bus Interrupt Schedule

PROGRAMMING INFORMATION (Z8031)

The Z8031 contains 11 write registers in each channel that are programmed by the system separately to configure the functional personality of the channels.

All of the registers in the Z8031 are directly addressable. How the Z8031 decodes the address placed on the address/data bus at the beginning of a Read or Write cycle is controlled by a command issued in WR0B. In the shift right mode, the channel select \bar{A}/\bar{B} is taken from AD₀ and the state of AD₅ is ignored. In the shift left mode, \bar{A}/\bar{B} is taken from AD₅ and the state of AD₀ is ignored. AD₇ and AD₆ are always ignored as address bits and the register address itself occupies AD₄-AD₁.

The system program first issues a series of commands to initialize the basic mode of operation. For example, the character length, clock rate, number of stop bits, even or odd parity might be set first. Then the interrupt mode would be set, and finally, receiver or transmitter enable.

PROGRAMMING INFORMATION (Z8531)

The Z8531, register addressing is direct for the data registers only, which are selected by a High on the D/ \bar{C} pin. In all other cases (with the exception of WR0 and RR0), programming the write registers requires two write operations and reading the read registers requires both a write and a read operation. The first write is to WR0 and contains three bits that point to the selected register. The second write is the actual control word

for the selected register, and if the second operation is read, the selected read register is accessed. All of the registers in the Z8531, including the data registers, may be accessed in this fashion. The pointer bits are automatically cleared after the read or write operation so that WRO (or RRO) is addressed again.

The system program first issues a series of commands to initialize the basic mode of operation. For example, the character length, clock rate, number of stop bits, even or odd parity might be set first. Then the interrupt mode would be set, and finally, receiver or transmitter enable.

READ REGISTERS

The ASCC contains 8 read registers (actually 9, counting the receive buffer (RR8) in each channel). Four of these may be read to obtain status information (RR0, RR1, RR10 and RR15). Two registers (RR12 and RR13) may be read to learn the baud rate generator time constant. RR2 contains either the unmodified interrupt vector (Channel A) or the vector modified by status information (Channel B). RR3 contains the interrupt Pending (IP) bits (Channel A). Figure 6 shows the formats for each read register.

The status bits of RR0 and RR1 are carefully grouped to simplify status monitoring; e.g., when the interrupt vector indicates a Special Receive Condition interrupt, all the appropriate error bits can be read from a single register (RR1).

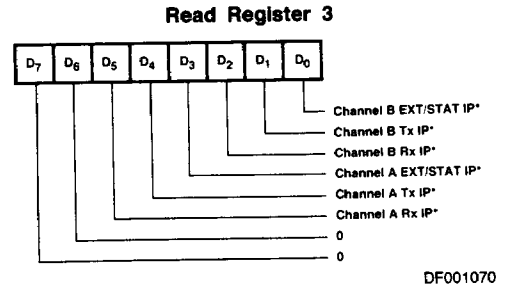
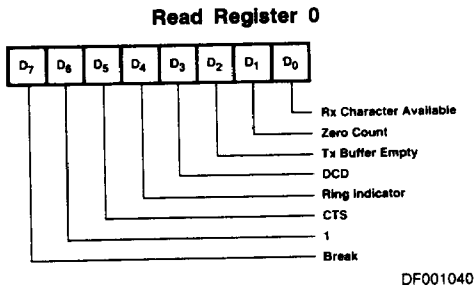

*Always 0 in B Channel

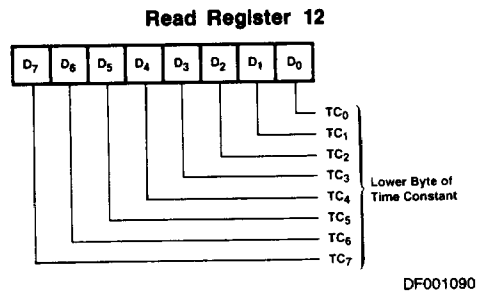
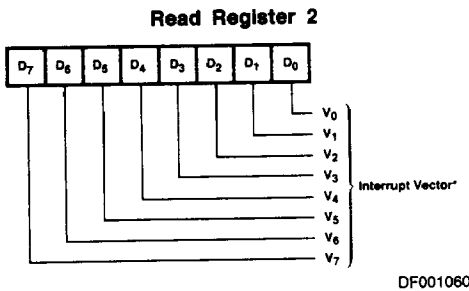
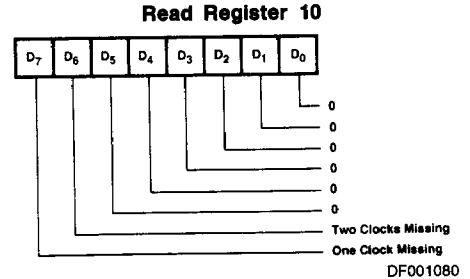
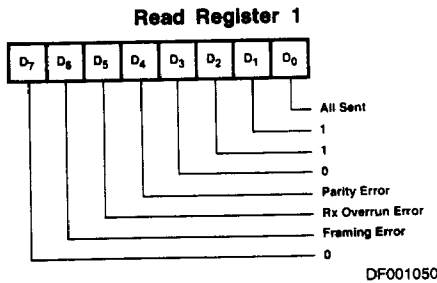

*Modified in B Channel

Figure 6. Read Register Bit Functions

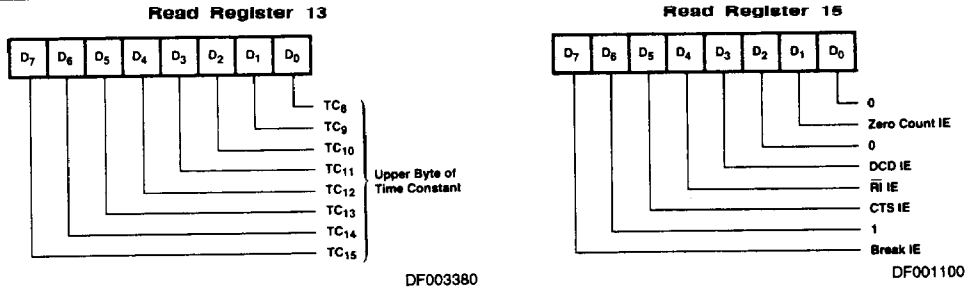

Figure 6. Read Register Bit Functions (Cont.)

WRITE REGISTERS

The ASCC contains 11 write registers (12 counting WR8, the transmit buffer) in each channel. These write registers are programmed separately to configure the functional "personal-

ty" of the channels. In addition, there are two registers (WR2 and WR9) shared by the two channels that may be accessed through either of them. WR2 contains the interrupt vector for both channels, while WR9 contains the interrupt control bits. Figure 7 shows the format of each write register.

Write Register 0 (Z8031)

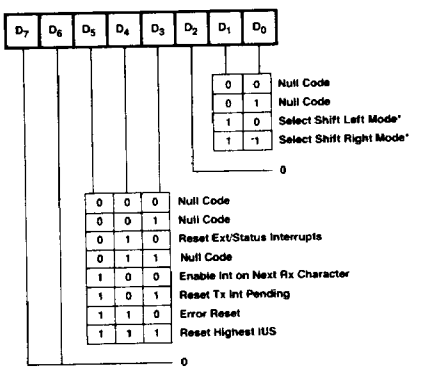

DF001110

Write Register 1

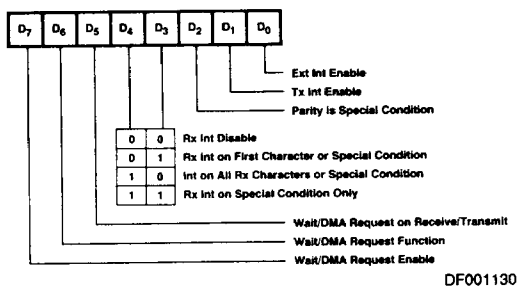

DF001130

Write Register 0 (Z8531)

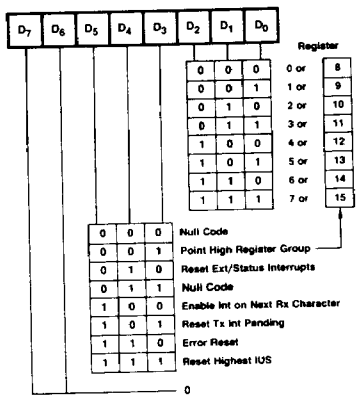

DF001120

Write Register 2

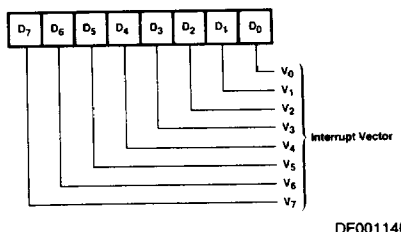

DF001140

Write Register 3

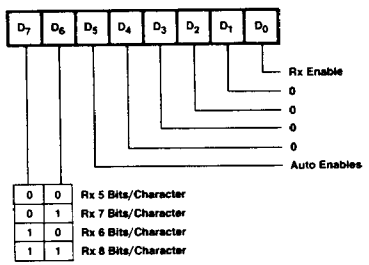

DF001150

Figure 7. Write Register Bit Functions

Write Register 1

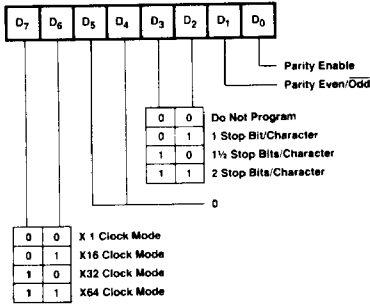

Write Register 11

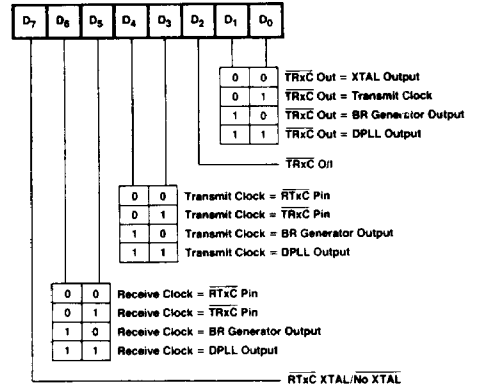

Write Register 5

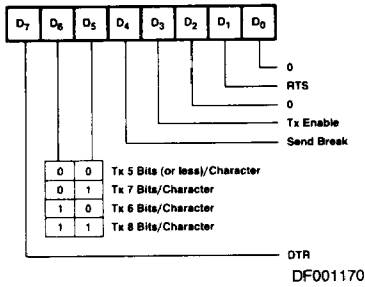

Write Register 12

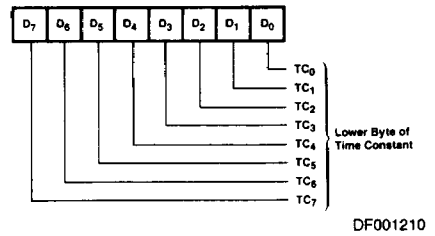

Write Register 9

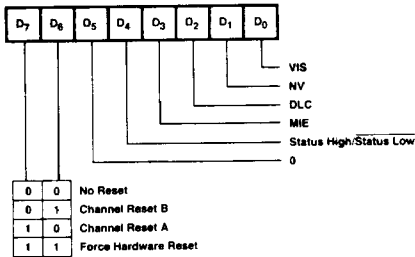

Write Register 13

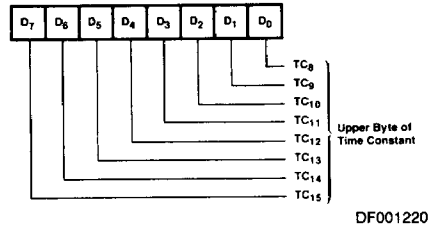

Write Register 10

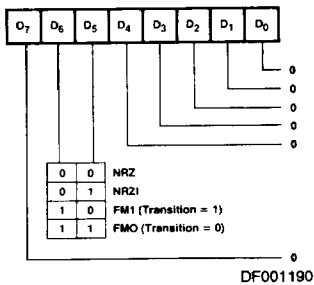

Write Register 14

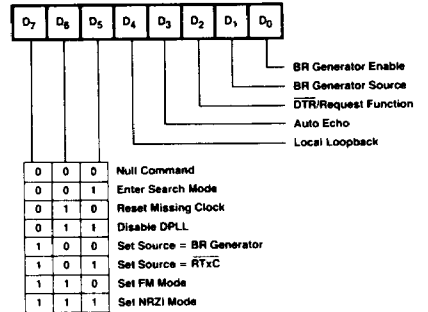

Figure 7. Write Register Bit Functions (Cont.)

Write Register 15

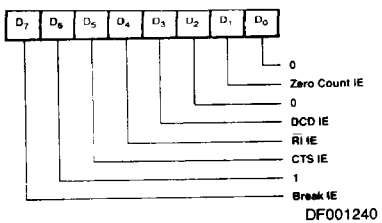

Figure 7. Write Register Bit Functions (Cont.)

Z8031 TIMING

The ASCC generates internal control signals from \overline{AS} and \overline{DS} that are related to PCLK. Since PCLK has no phase relationship with \overline{AS} and \overline{DS} , the circuitry generating these internal control signals must provide time for metastable conditions to disappear. This gives rise to a recovery time related to PCLK. The recovery time applies only between bus transactions involving the ASCC to the falling edge of \overline{DS} in the second transaction involving the ASCC. This time must be at least 6 PCLK cycles plus 200ns.

READ CYCLE TIMING

Figure 8 illustrates read cycle timing. The address on AD₀-AD₇ and the state of \overline{CS}_0 and \overline{INTACK} are latched by the rising edge of \overline{AS} . R/ \overline{W} must be High to indicate a read cycle. \overline{CS}_1 must also be High for the read cycle to occur. The data bus drivers in the ASCC are then enabled while \overline{DS} is Low.

WRITE CYCLE TIMING

Figure 9 illustrates write cycle timing. The address on AD₀-AD₇ and the state of \overline{CS}_0 and \overline{INTACK} are latched by the rising edge of \overline{AS} . R/ \overline{W} must be Low to indicate a write cycle. \overline{CS}_1 must be High for the write cycle to occur. \overline{DS} Low strobes the data into the ASCC.

INTERRUPT ACKNOWLEDGE CYCLE TIMING

Figure 10 illustrates interrupt acknowledge cycle timing. The address on AD₀-AD₇ and the state of \overline{CS}_0 and \overline{INTACK} are latched by the rising edge of \overline{AS} . However, if \overline{INTACK} is Low, the address and \overline{CS}_0 are ignored. The state of R/ \overline{W} and \overline{CS}_1 are also ignored for the duration of the interrupt acknowledge cycle. Between the rising edge of \overline{AS} and the falling edge of \overline{DS} , the internal and external IEI/IEO daisy chains settle. If there is an interrupt pending in the ASCC and IEI is High when \overline{DS} falls, the acknowledge cycle was intended for the ASCC. In this case, the ASCC may be programmed to respond to \overline{DS} Low by placing its interrupt vector on AD₀-AD₇. It then sets the appropriate interrupt-under-service latch internally.

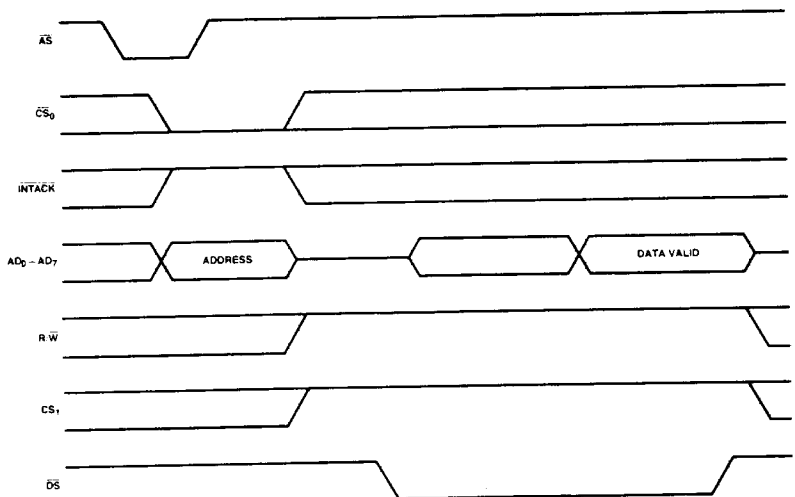

WF003391

Figure 8. Z8031 Read Cycle Timing

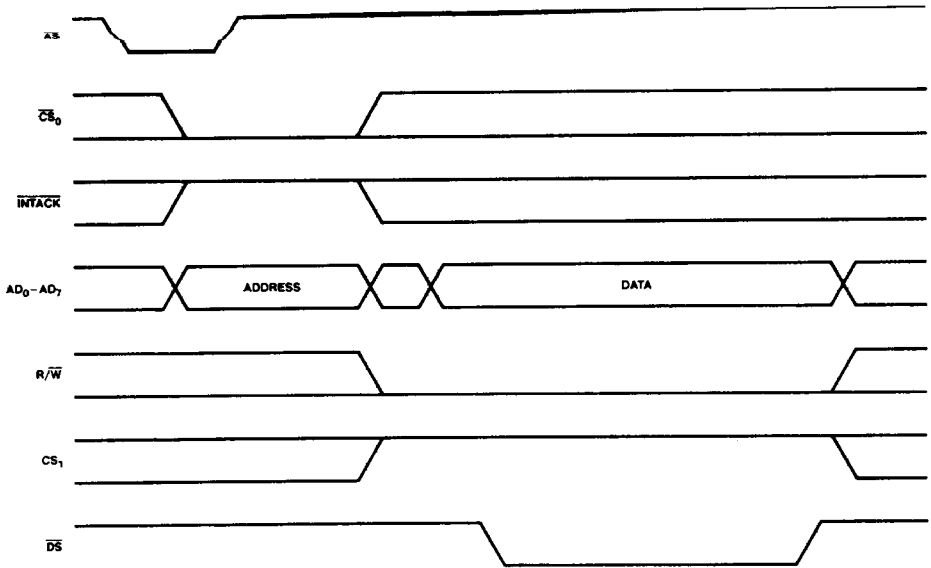

WF003410

Figure 9. Z8031 Write Cycle Timing

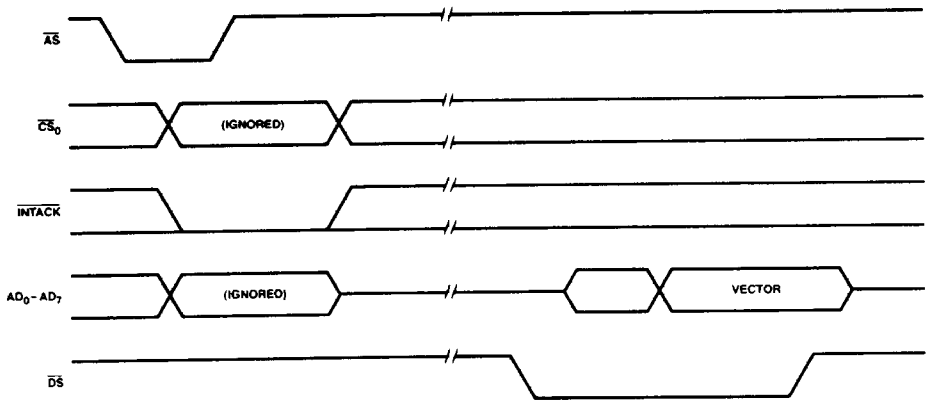

WF003400

Figure 10. Z8031 Interrupt Acknowledge Cycle Timing

Z8531 TIMING

The ASCC generates internal control signals from \overline{WR} and \overline{RD} that are related to PCLK. Since PCLK has no phase relationship with \overline{WR} and \overline{RD} , the circuitry generating these internal control signals must provide time for metastable conditions to disappear. This gives rise to a recovery time related to PCLK. The recovery time applies only between bus transactions involving the ASCC. The recovery time required for proper operation is specified from the rising edge of \overline{WR} or \overline{RD} in the first transaction involving the ASCC to the falling edge of \overline{WR} or \overline{RD} in the second transaction involving the ASCC. This time must be at least 6 PCLK cycles plus 200ns.

READ CYCLE TIMING

Figure 11 illustrates read cycle timing. Addresses on A/\overline{B} and D/\overline{C} and the status on \overline{INTACK} must remain stable throughout the cycle. If \overline{CE} falls after \overline{RD} falls or if it rises before \overline{RD} rises, the effective \overline{RD} is shortened.

WRITE CYCLE TIMING

Figure 12 illustrates write cycle timing. Addresses on A/\overline{B} and D/\overline{C} and the status on \overline{INTACK} must remain stable throughout the cycle. If \overline{CE} falls after \overline{WR} falls or if it rises before \overline{WR} rises, the effective \overline{WR} is shortened.

INTERRUPT ACKNOWLEDGE CYCLE TIMING

Figure 13 illustrates interrupt acknowledge cycle timing. Between the time $\overline{\text{INTACK}}$ goes Low and the falling edge of $\overline{\text{RD}}$, the internal and external IEI/IEO daisy chains settle. If there is

an interrupt pending in the ASCC and IEI is High when $\overline{\text{RD}}$ falls, the acknowledge cycle is intended for the ASCC. In this case, the ASCC may be programmed to respond to $\overline{\text{RD}}$ Low by placing its interrupt vector on $\text{D}_0\text{-D}_7$; it then sets the appropriate interrupt-under-service latch internally.

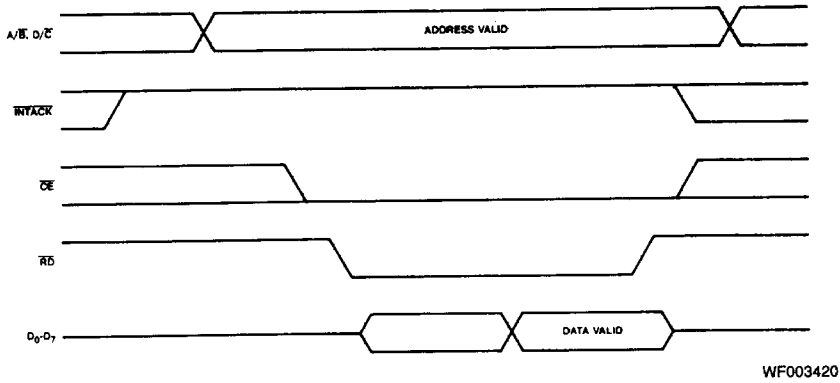

Figure 11. Z8531 Read Cycle Timing

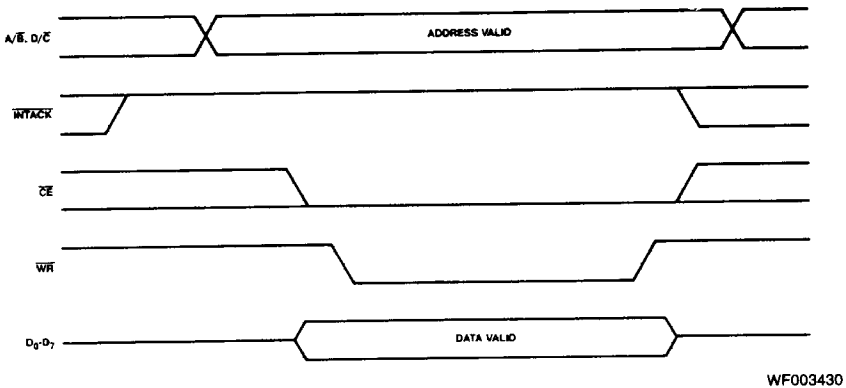

Figure 12. Z8531 Write Cycle Timing

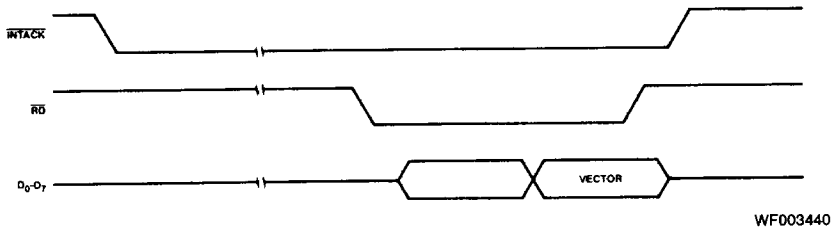

Figure 13. Z8531 Interrupt Acknowledge Cycle Timing

ABSOLUTE MAXIMUM RATINGS

Storage Temperature -65 to +150°C
 Voltage at any Pin Relative to V_{SS} -0.5V to +7.0V
 Power Dissipation 1.8W

Stresses above those listed under ABSOLUTE MAXIMUM RATINGS may cause permanent device failure. Functionality at or above these limits is not implied. Exposure to absolute maximum ratings for extended periods may affect device reliability.

OPERATING RANGES

Commercial (C) Devices
 Temperature (T_A) 0 to 70°C
 Supply Voltage (V_{CC}) 5 V ±5%

Operating ranges define those limits between which the functionality of the device is guaranteed.

DC CHARACTERISTICS over operating range unless otherwise specified

Parameters	Description	Test Conditions	Min	Typ	Max	Units
V _{IH}	Input HIGH Voltage		2.0		V _{CC} + 0.3	V
V _{IL}	Input LOW Voltage		-0.3		0.8	V
V _{OH}	Output HIGH Voltage	I _{OH} = -250µA	2.4			V
V _{OL}	Output LOW Voltage	I _{OL} = +2.0mA			0.4	V
I _{IH}	Input Leakage	V _{SS} ≤ V _{IN} + V _{CC}			±10.0	µA
I _{OL}	Output Leakage	V _{SS} ≤ V _{OUT} + V _{CC}			±10.0	µA
I _{CC}	V _{CC} Supply Current				250	mA
C _{IN}	Input Capacitance	Unmeasured pins returned to ground. f = 1 MHz at T _A = 25°C.			10	pF
C _{OUT}	Output Capacitance				15	pF
C _{I/O}	Bidirectional Capacitance				20	pF

Standard Test Conditions

The characteristics below apply for the following standard test conditions, unless otherwise noted. All voltages are referenced to GND. Positive current flows into the referenced pin. Standard conditions are as follows:

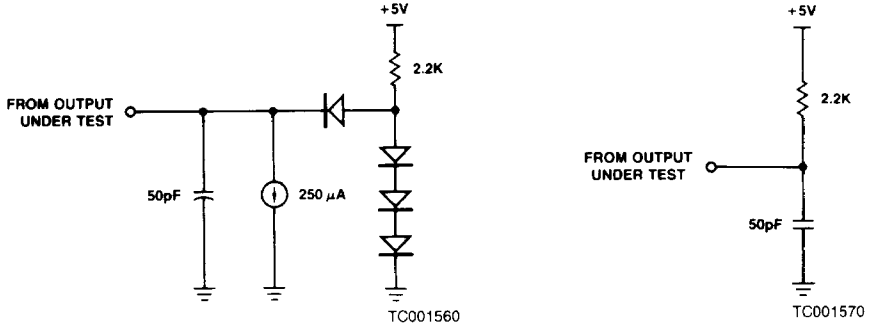

A. Standard Test Load

B. Open-Drain Test Load

SWITCHING TEST WAVEFORM

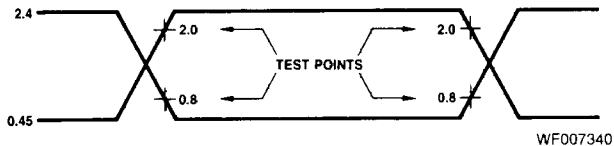

AC testing inputs are driven at 2.4 V for a logic "1" and 0.45 V for a logic "0." Timing measurements are made at 2.0 V for a logic "1" and 0.8 V for a logic "0."

SWITCHING CHARACTERISTICS over operating ranges unless otherwise specified

Z8031/Z8531

Z8531 System Timing

Number	Parameters	Description	4MHz		6MHz		Units
			Min	Max	Min	Max	
1	TdRXC(REQ)	RxC ↑ to W/REQ Valid Delay (Note 2)	8	12	8	12	TcPC
2	TdRXC(W)	RxC ↓ to Wait Inactive Delay (Notes 1, 2)	8	14	8	14	TcPC
3	TdRXC(INT)	RxC ↑ to INT Valid Delay (Notes 1, 2)	10	16	10	16	TcPC
4	TdTXC(REQ)	TxC ↓ to W/REQ Valid Delay (Note 3)	5	8	5	8	TcPC
5	TdTXC(W)	TxC ↓ to Wait Inactive Delay (Notes 1, 3)	5	11	5	11	TcPC
6	TdTXC(DRQ)	TxC ↓ DTR/REQ Valid Delay (Note 3)	4	7	4	7	TcPC
7	TdTXC(INT)	TxC ↓ to INT Valid Delay (Notes 1, 3)	6	10	6	10	TcPC
8	TdEXT(INT)	DCD or CTS Transition to INT Valid Delay (Note 1)	2	6	2	6	TcPC

Notes: 1. Open-drain output, measured with open-drain test load.
 2. RxC is RTxC or TRxC, whichever is supplying the receive clock.
 3. TxC is TRxC or RTxC, whichever is supplying the transmit clock.

Z8031 System Timing

Number	Parameters	Description	4MHz		6MHz		Units
			Min	Max	Min	Max	
1	TdRXC(REQ)	RxC ↑ to W/REQ Valid Delay (Note 2)	8	12	8	12	TcPC
2	TdRXC(W)	RxC ↓ to Wait Inactive Delay (Notes 1, 2)	8	14	8	14	TcPC
3	TdRXC(INT)	RxC ↑ INT Valid Delay (Notes 1, 2)	8 +2	12 +3	8 +2	12 +3	TcPC AS
4	TdTXC(REQ)	TxC ↓ to W/REQ Valid Delay (Note 3)	5	8	5	8	TcPC
5	TdTXC(W)	TxC ↓ to Wait Inactive Delay (Notes 1, 3)	5	11	5	11	TcPC
6	TdTXC(DRQ)	TxC ↓ DTR/REQ Valid Delay (Note 3)	4	7	4	7	TcPC
7	TdTXC(INT)	TxC ↓ to INT Valid Delay (Notes 1, 3)	4 +2	6 +3	4 +2	6 +3	TcPC AS
8	TdEXT(INT)	DCD, RI or CTS Transition to INT Valid Delay (Note 1)	2	3	2	3	AS

Notes: 1. Open-drain output, measured with open-drain test load.
 2. RxC is RTxC or TRxC, whichever is supplying the receive clock.
 3. TxC is TRxC or RTxC, whichever is supplying the transmit clock.

5

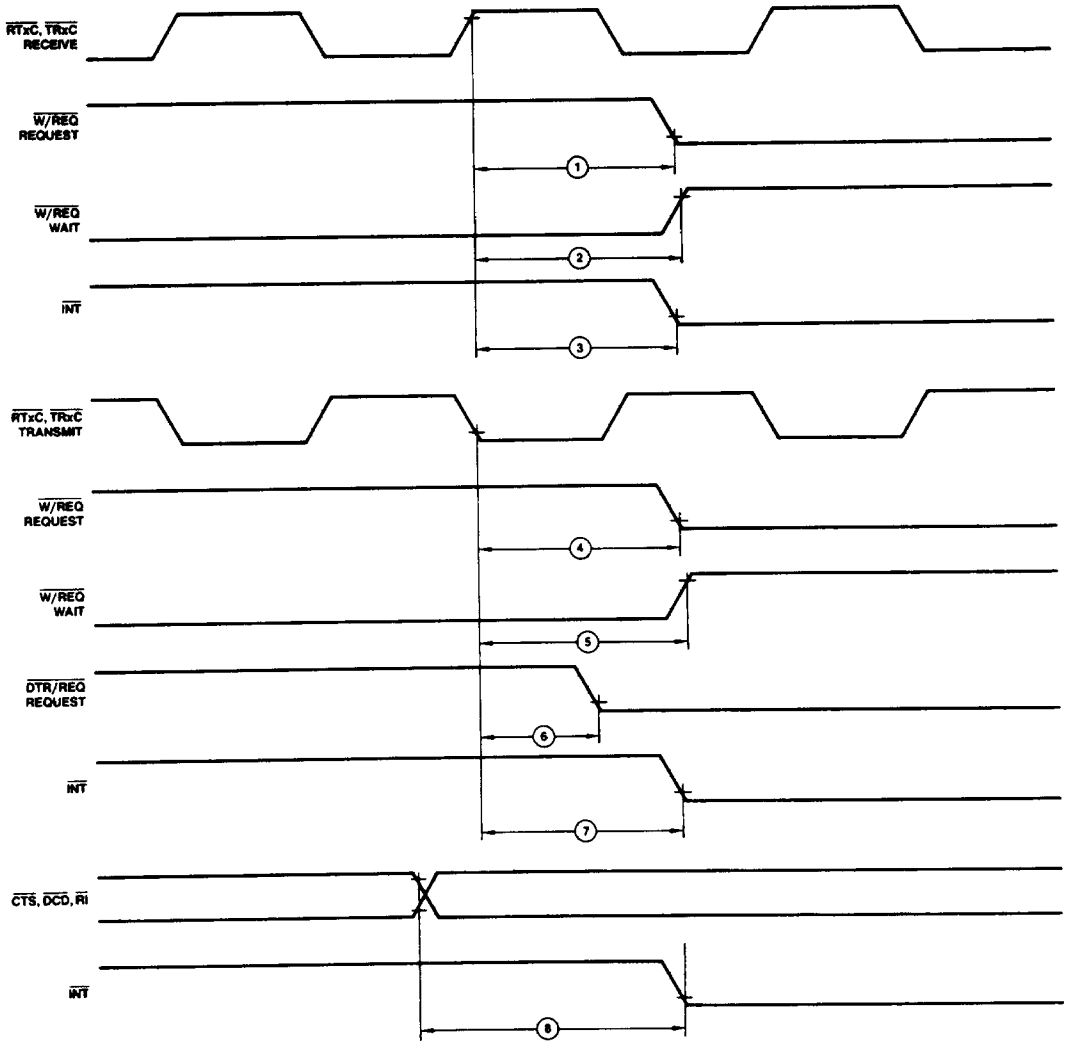

WF003450

Figure 14. System Timing

SWITCHING CHARACTERISTICS (Cont'd.)

General Timing (See Figure 15)

Number	Parameters	Description	4MHz		6MHz		Units
			Min	Max	Min	Max	
1	TdPC(REQ)	PCLK ↓ to W/REQ Valid Delay		250		250	ns
2	TdPC(W)	PCLK ↓ to Wait Inactive Delay		350		350	ns
3	TsRXC(PC)	RxC ↑ to PCLK ↑ Setup Time (Notes 1, 4)	80	TwPCL	70	TwPCL	ns
4	TsRXD(RXCr)	RxD to RxC ↑ Setup Time (X1 Mode) (Note 1)	0		0		ns
5	ThRXD(RXCr)	RxD to RxC ↑ Hold Time (X1 Mode) (Note 1)	150		150		ns
6	TsRXD(RXCf)	RxD to RxC ↓ Setup Time (X1 Mode) (Notes 1, 5)	0		0		ns
7	ThRXD(RXCf)	RxD to RxC ↓ Hold Time (X1 Mode) (Notes 1, 5)	150		150		ns
8	TsTXC(PC)	TxC ↓ to PCLK ↑ Setup Time (Notes 2, 4)	0		0		ns
9	TdTXC(TXD)	TxC ↓ to TxD Delay (X1 Mode) (Note 2)		300		230	ns
10	TdTXC(TXD)	TxC ↑ to TxD Delay (X1 Mode) (Notes 2, 5)		300		230	ns
11	TdTXD(TRX)	TxD to TRxC Delay (Send Clock Echo)		200		200	ns
12	TwRTXh	RTxC High Width (Note 6)	180		180		ns
13	TwRTXl	RTxC Low Width (Note 6)	180		180		ns
14	TcRTX	RTxC Cycle Time (Notes 6, 7)	1000		660		ns
15	TcRTXX	Crystal Oscillator Period (Note 3)	250	1000	165	1000	ns
16	TwTRXh	TRxC High Width (Note 6)	180		180		ns
17	TwTRXl	TRxC Low Width (Note 6)	180		180		ns
18	TcTRX	TRxC Cycle Time (Notes 6, 7)	1000		660		ns
19	TwEXT	DCD or CTS Pulse Width	200		200		ns

- Notes:
1. RxC is RTxC or TRxC, whichever is supplying the receive clock.
 2. TxC is TRxC or RTxC, whichever is supplying the transmit clock.
 3. Both RTxC and TRxC have 30pF capacitors to the ground connected to them.
 4. Parameter applies only if the data rate is one-fourth the PCLK rate. In all other cases, no phase relationship between RxC and PCLK or TxC and PCLK is required.
 5. Parameter applies only to FM encoding/decoding.
 6. Parameter applies only to transmitter and receiver; DPLL and baud rate generator timing requirements are identical to chip PCLK requirements.
 7. The maximum receive or transmit data is 1/4 PCLK.

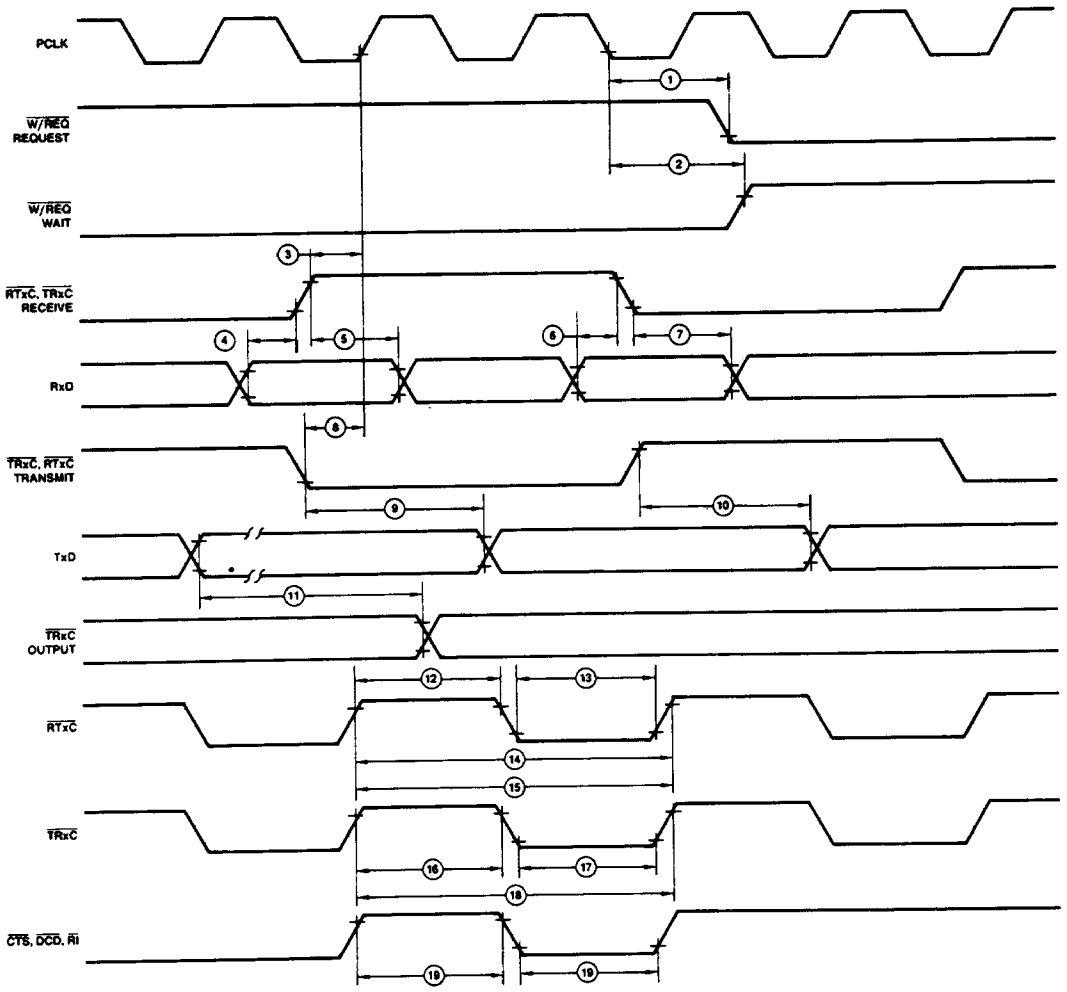

WF003460

Figure 15. General Timing

SWITCHING CHARACTERISTICS (Cont'd.)
Z8031 Read and Write Timing (see Figure 16)

Number	Parameters	Description	4MHz		6MHz		Units
			Min	Max	Min	Max	
1	TwAS	\overline{AS} LOW Width	70		50		ns
2	TdDS(AS)	$\overline{DS} \uparrow$ to $\overline{AS} \downarrow$ Delay	50		25		ns
3	TsCS0(AS)	\overline{CS}_0 to $\overline{AS} \uparrow$ Setup Time (Note 1)	0		0		ns
4	ThCS0(AS)	\overline{CS}_0 to $\overline{AS} \downarrow$ Hold Time (Note 1)	60		40		ns
5	TsCS1(DS)	CS_1 to $\overline{DS} \downarrow$ Setup Time (Note 1)	100		80		ns
6	ThCS1(DS)	CS_1 to $\overline{DS} \uparrow$ Hold Time (Note 1)	55		40		ns
7	TsIA(AS)	\overline{INTACK} to $\overline{AS} \uparrow$ Setup Time	10		10		ns
8	ThIA(AS)	\overline{INTACK} to $\overline{AS} \downarrow$ Hold Time	250		200		ns
9	TsRWR(DS)	R/ \overline{W} (Read) to $\overline{DS} \downarrow$ Setup Time	100		80		ns
10	ThRW(DS)	R/ \overline{W} to $\overline{DS} \uparrow$ Hold Time	55		40		ns
11	TsRWW(DS)	R/ \overline{W} (Write) to $\overline{DS} \downarrow$ Setup Time	0		0		ns
12	TdAS(DS)	$\overline{AS} \downarrow$ to $\overline{DS} \downarrow$ Delay	60		40		ns
13	TwDSI	\overline{DS} LOW Width	390		250		ns
14	TrC	Valid Access Recovery Time (Note 2)	6TcPC + 200		6TcPC + 130		ns
15	TsA(AS)	Address to $\overline{AS} \uparrow$ Setup Time (Note 1)	30		10		ns
16	ThA(AS)	Address to $\overline{AS} \downarrow$ Hold Time (Note 1)	50		30		ns
17	TsDW(DS)	Write Data to $\overline{DS} \downarrow$ Setup Time	30		20		ns
18	ThDW(DS)	Write Data to $\overline{DS} \uparrow$ Hold Time	30		20		ns
19	TdDS(DA)	$\overline{DS} \downarrow$ to Data Active Delay	0		0		ns
20	TdDSr(DR)	$\overline{DS} \uparrow$ to Read Data Not Valid Delay	0		0		ns
21	TdDSf(DR)	$\overline{DS} \downarrow$ to Read Data Valid Delay		250		180	
22	TdAS(DR)	$\overline{AS} \uparrow$ to Read Data Valid Delay		520		335	ns

Notes: 1. Parameter does not apply to Interrupt Acknowledge transactions.
 2. Parameter applies only between transactions involving the SCC.

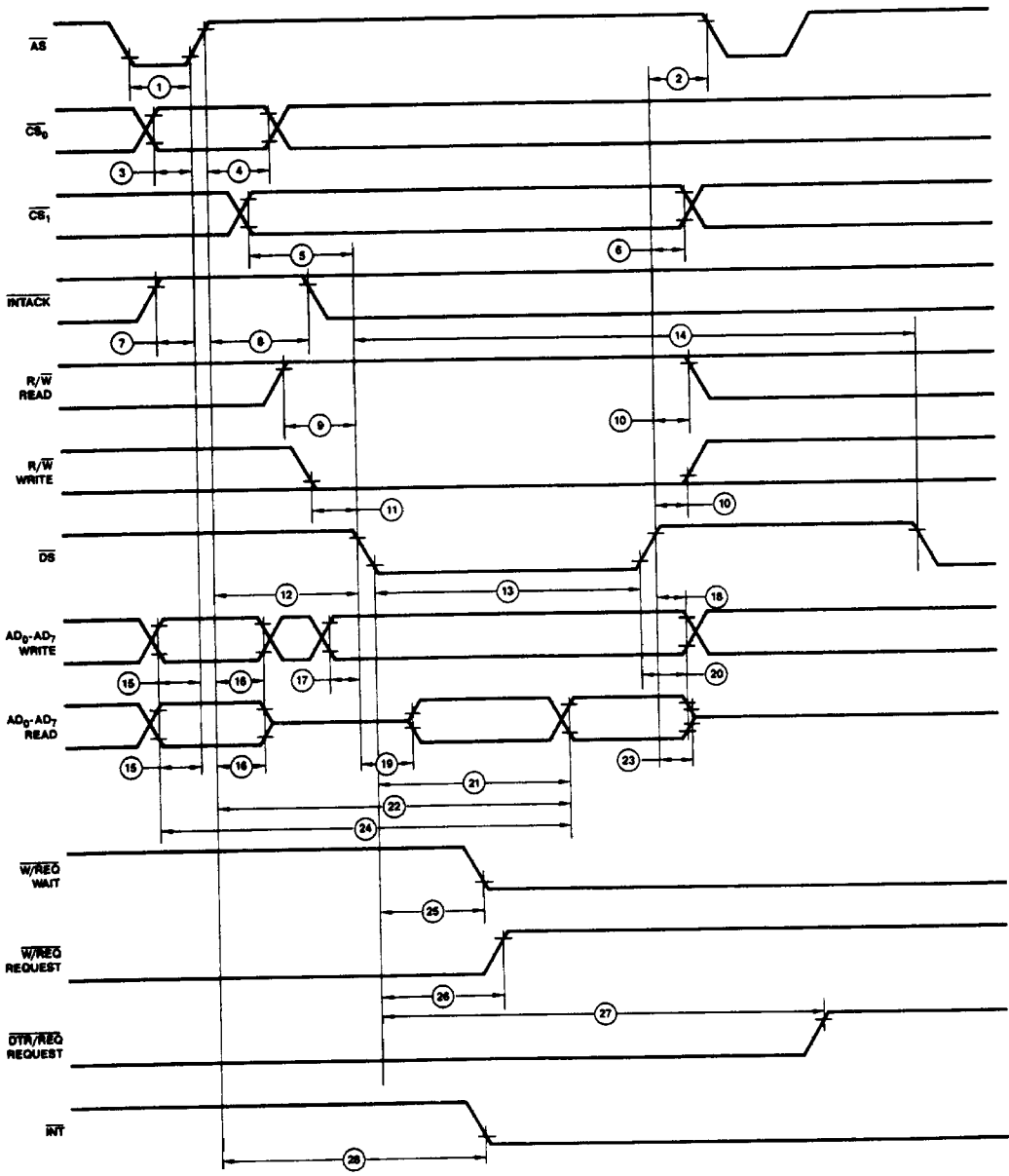

WF003472

Figure 16. Z8031 Read and Write Timing

SWITCHING CHARACTERISTICS (Cont'd.)

Z8531 Read and Write Timing (see Figure 20)

Number	Parameters	Description	4MHz		6MHz		Units
			Min	Max	Min	Max	
1	TwPCI	PCLK Low Width	105	2000	70	1000	ns
2	TwPCh	PCLK High Width	105	2000	70	1000	ns
3	TfPC	PCLK Fall Time		20		10	ns
4	TrPC	PCLK Rise Time		20		10	ns
5	TcPC	PCLK Cycle Time	250	4000	165	2000	ns
6	TsA(WR)	Address to \overline{WR} ↓ Setup Time	80		80		ns
7	ThA(WR)	Address to \overline{WR} ↑ Hold Time	0		0		ns
8	TsA(RD)	Address to \overline{RD} ↓ Setup Time	80		80		ns
9	ThA(RD)	Address to \overline{RD} ↑ Hold Time	0		0		ns
10	TsI(PC)	\overline{INTACK} to PCLK ↑ Setup Time	10		10		ns
11	TsI(KWR)	\overline{INTACK} to \overline{WR} ↓ Setup Time (Note 1)	200		160		ns
12	ThI(WR)	\overline{INTACK} to \overline{WR} ↑ Hold Time	0		0		ns
13	TsI(KRD)	\overline{INTACK} to \overline{RD} ↓ Setup Time (Note 1)	200		160		ns
14	ThI(RD)	\overline{INTACK} to \overline{RD} ↑ Hold Time	0		0		ns
15	ThI(PC)	\overline{INTACK} to PCLK ↑ Hold Time	100		100		ns
16	TsCEI(WR)	\overline{CE} Low to \overline{WR} ↓ Setup Time	0		0		ns
17	ThCE(WR)	\overline{CE} to \overline{WR} ↑ Hold Time	0		0		ns
18	TsCEh(WR)	\overline{CE} High to \overline{WR} ↓ Setup Time	100		70		ns
19	TsCEI(RD)	\overline{CE} Low to \overline{RD} ↓ Setup Time (Note 1)	0		0		ns
20	ThCE(RD)	\overline{CE} to \overline{RD} ↑ Hold Time (Note 1)	0		0		ns
21	TsCEh(RD)	\overline{CE} High to \overline{RD} ↓ Setup Time (Note 1)	100		70		ns
22	TwRDI	\overline{RD} Low Width (Note 1)	240		200		ns
23	TdRD(DRA)	\overline{RD} ↓ to Read Data Active Delay	0		0		ns
24	TdRDr(DR)	\overline{RD} ↓ to Read Data Not Valid Delay	0		0		ns
25	TdRDf(DR)	\overline{RD} ↓ to Read Data Valid Delay		250		180	ns
26	TdRD(DRz)	\overline{RD} ↓ to Read Data Float Delay (Note 2)		70		45	ns

Notes: 1. Parameter does not apply to Interrupt Acknowledge transactions.

2. Float delay is defined as the time required for a $\pm 0.5V$ change in the output with a maximum D.C. load and minimum A.C. load.

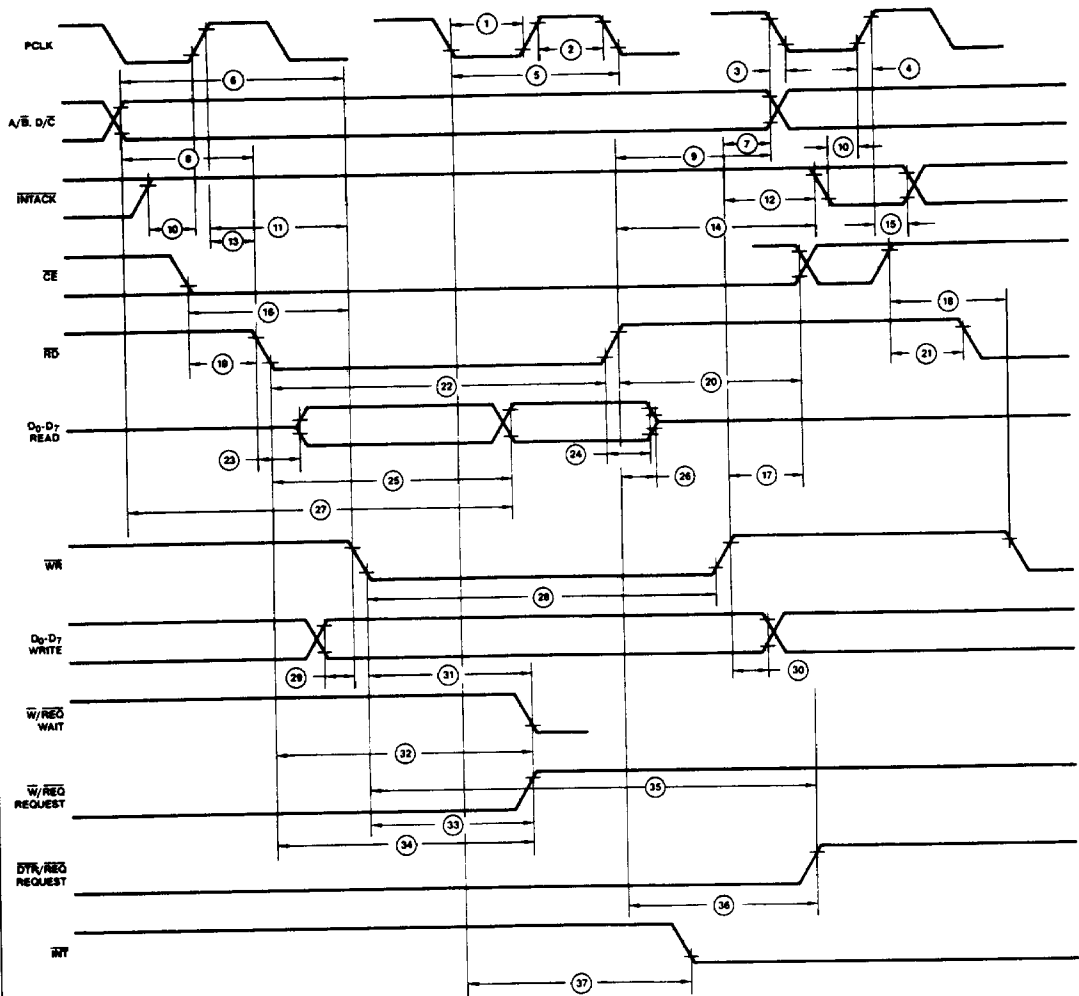

WF003511

Figure 20. Z8531 Read and Write Timing

SWITCHING CHARACTERISTICS (Cont'd.)**Z8031 Interrupt Acknowledge Timing, Reset Timing, Cycle Timing** (see Figures 17, 18, 19)

Number	Parameters	Description	4MHz		6MHz		Units
			Min	Max	Min	Max	
23	TdDS(DRz)	$\overline{DS} \uparrow$ to Read Data Float Delay (Note 3)		70		45	ns
24	TdA(DR)	Address Required Valid to Read Data Valid Delay		570		310	ns
25	TdDS(W)	$\overline{DS} \downarrow$ to Wait Valid Delay (Note 4)		240		200	ns
26	TdDSr(REQ)	$\overline{DS} \downarrow$ to $\overline{W}/\overline{REQ}$ Not Valid Delay		240		200	ns
27	TdDSr(REQ)	$\overline{DS} \downarrow$ to $\overline{DTR}/\overline{REQ}$ Not Valid Delay		5TcPC + 300		5TcPC + 250	ns
28	TdAS(INT)	$\overline{AS} \uparrow$ to \overline{INT} Valid Delay (Note 4)		500		500	ns
29	TdAS(DSA)	$\overline{AS} \uparrow$ to $\overline{DS} \downarrow$ (Acknowledge) Delay (Note 5)	250		250		ns
30	TwDSA	\overline{DS} (Acknowledge) Low Width	390		250		ns
31	TdDSA(DR)	$\overline{DS} \downarrow$ (Acknowledge) to Read Data Valid Delay		250		180	ns
32	TsIEI(DSA)	IEI to $\overline{DS} \downarrow$ (Acknowledge) Setup Time	120		100		ns
33	ThIEI(DSA)	IEI to $\overline{DS} \uparrow$ (Acknowledge) Hold Time	0		0		ns
34	TdIEI(IEO)	IEI to IEO Delay		120		100	ns
35	TdAS(IEO)	$\overline{AS} \uparrow$ to IEO Delay (Note 6)		250		250	ns
36	TdDSA(INT)	$\overline{DS} \downarrow$ (Acknowledge) to \overline{INT} Inactive Delay (Note 4)		500		500	ns
37	TdDS(ASQ)	$\overline{DS} \uparrow$ to $\overline{AS} \downarrow$ Delay for No Reset	30		15		ns
38	TdASQ(DS)	$\overline{AS} \uparrow$ to $\overline{DS} \downarrow$ Delay for No Reset	30		30		ns
39	TwRES	\overline{AS} and \overline{DS} Coincident Low for Reset (Note 7)	250		200		ns
40	TwPCI	PCLK Low Width	105	2000	70	1000	ns
41	TwPCh	PCLK High Width	105	2000	70	1000	ns
42	TcPC	PCLK Cycle Time	250	4000	165	2000	ns
43	TrPC	PCLK Rise Time		20		10	ns
44	TfPC	PCLK Fall Time		20		10	ns

Notes: 3. Float delay is defined as the time required for a $\pm 0.5V$ change in the output with a maximum D.C. load and minimum A.C. load.

4. Open-drain output, measured with open-drain test load.

5. Parameter is system dependent. For any Z-SCC in the daisy chain, TdAS(DSA) must be greater than the sum of TdAS(IEO) for the highest priority device in the daisy chain, TsIEI(DSA) for the Z-SCC, and TdIEI(IEO) for each device separating them in the daisy chain.

6. Parameter applies only to a 8031 pulling \overline{INT} Low at the beginning of the Interrupt Acknowledge transaction.

7. Internal circuitry allows for the reset provided by the Z8 to be recognized as a reset by the Z-SCC.

All timing references assume 2.0 V for a logic "1" and 0.8 V for a logic "0".

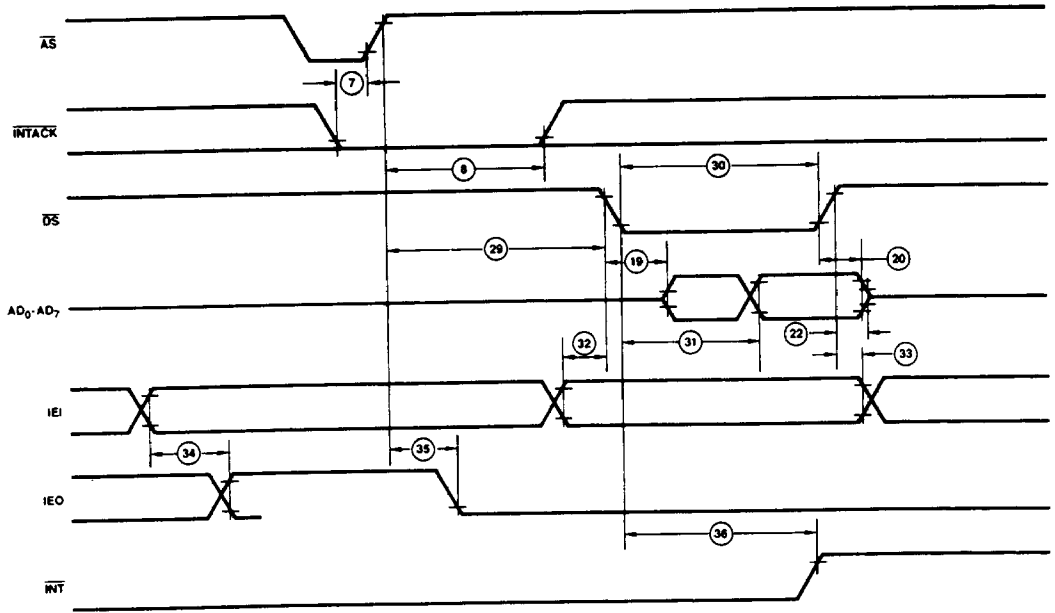

WF003480

Figure 17. Z8031 Interrupt Acknowledge Timing

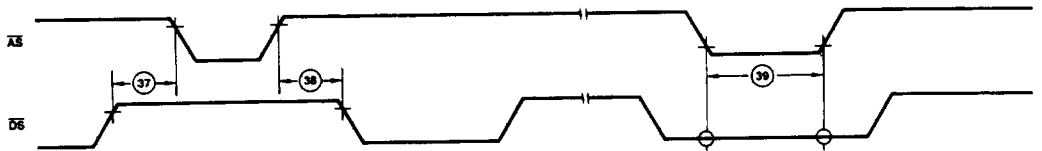

WF003490

Figure 18. Z8031 Reset Timing

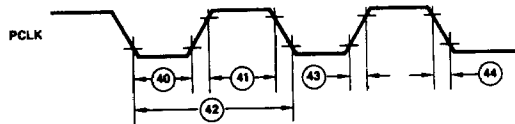

WF003500

Figure 19. Z8031 Cycle Timing

SWITCHING CHARACTERISTICS (Cont'd.)

Z8531 Interrupt Acknowledge Timing, Reset Timing, Cycle Timing (see Figures 21, 22, 23)

Number	Parameters	Description	4MHz		6MHz		Units
			Min	Max	Min	Max	
27	TdA(DR)	Address Required Valid to Read Data Valid Delay		400		350	ns
28	TwWRI	\overline{WR} Low Width	240		200		ns
29	TsDW(WR)	Write Data to \overline{WR} ↓ Setup Time	10		10		ns
30	ThDW(WR)	Write Data to \overline{WR} ↑ Hold Time	0		0		ns
31	TdWR(W)	\overline{WR} ↓ to Wait Valid Delay (Note 4)		240		200	ns
32	TdRD(W)	\overline{RD} ↓ to Wait Valid Delay (Note 4)		240		200	ns
33	TdWR(REQ)	\overline{WR} ↓ to $\overline{W}/\overline{REQ}$ Not Valid Delay		240		200	ns
34	TdRD(REQ)	\overline{RD} ↓ to $\overline{W}/\overline{REQ}$ Not Valid Delay		240		200	ns
35	TdWR(REQ)	\overline{WR} ↓ to $\overline{DTR}/\overline{REQ}$ Not Valid Delay		4TcPC		4TcPC	ns
36	TdRD(REQ)	\overline{RD} ↓ to $\overline{DTR}/\overline{REQ}$ Not Valid Delay		4TcPC		4TcPC	ns
37	TdPC(INT)	PCLK ↓ to \overline{INT} Valid Delay (Note 4)		500		500	ns
38	TdAI(RD)	\overline{INTACK} to \overline{RD} ↓ (Acknowledge) Delay (Note 5)	250		200		ns
39	TwRDA	\overline{RD} (Acknowledge) Width	250		200		ns
40	TdRDA(DR)	\overline{RD} ↓ (Acknowledge) to Read Data Valid Delay		250		180	ns
41	TsEI(RDA)	IEI to \overline{RD} ↓ (Acknowledge) Setup Time	120		100		ns
42	ThEI(RDA)	IEI to \overline{RD} ↑ (Acknowledge) Hold Time	0		0		ns
43	TdEI(IEO)	IEI to IEO Delay Time		120		100	ns
44	TdPC(IEO)	PCLK ↑ to IEO Delay		250		250	ns
45	TdRDA(INT)	\overline{RD} ↓ to \overline{INT} Inactive Delay (Note 4)		500		500	ns
46	TdRD(WRQ)	\overline{RD} ↑ to \overline{WR} ↓ Delay for No Reset	30		15		ns
47	TdWRQ(RD)	\overline{WR} ↑ to \overline{RD} ↓ Delay for No Reset	30		30		ns
48	TwRES	\overline{WR} and \overline{RD} Coincident Low for Reset	250		200		ns
49	Trc	Valid Access Recovery Time (Note 3)	6TcPC + 200		6TcPC + 130		ns

Notes: 3. Parameter applies only between transactions involving the SCC.

4. Open-drain output, measured with open-drain test load.

5. Parameter is system dependent. For any SCC in the daisy chain, TdAI(RD) must be greater than the sum of TdPC(IEO) for the highest priority device in the daisy chain, TsEI(RDA) for the SCC, and TdEI(IEO) for each device separating them in the daisy chain.

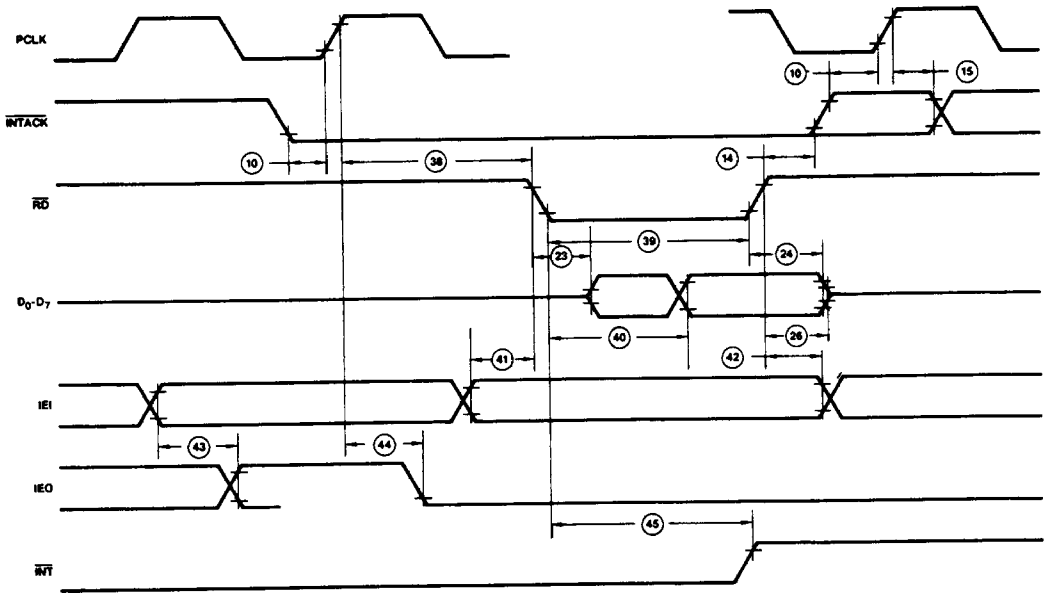

WF003520

Figure 21. Z8531 Interrupt Acknowledge Timing

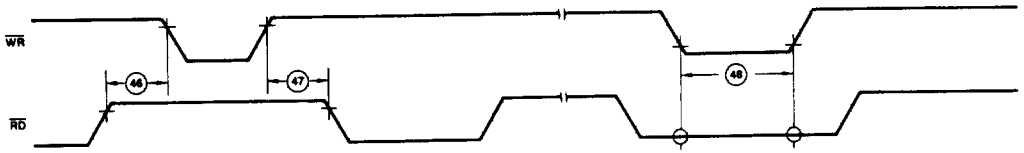

WF003530

Figure 22. Z8531 Reset Timing

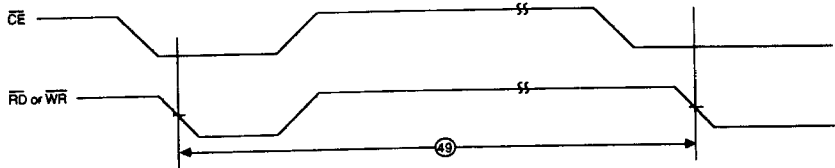

WF023820

Figure 23. Z8531 Cycle Timing