

Box Header 2.54mm



RoHS

Box Header 2.54mm SMT/Right Angle/Straight Type

Specifications

Current Rate: 3 AMP
 Insulation Resistance: 1000MΩ Min.
 Contact Resistance: 20mΩ Max.
 Dielectric Voltage: 1000V AC for one minute
 Operation Temperature: -40°C to +105°C

Material

Insulator: Polyester, UL 94V-0
 ©Standard: PBT or Nylon 6T
 Terminal: Copper Alloy
 Plating: Gold Plated

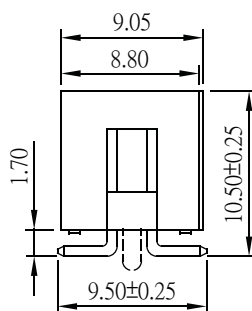
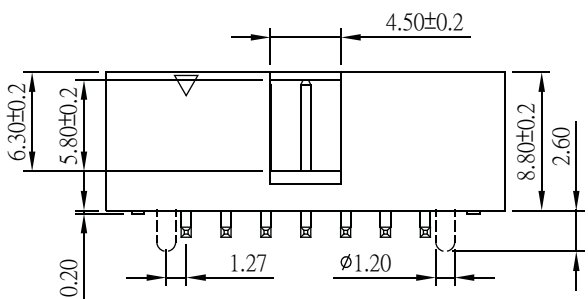
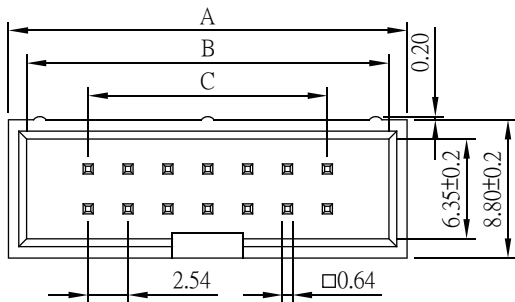
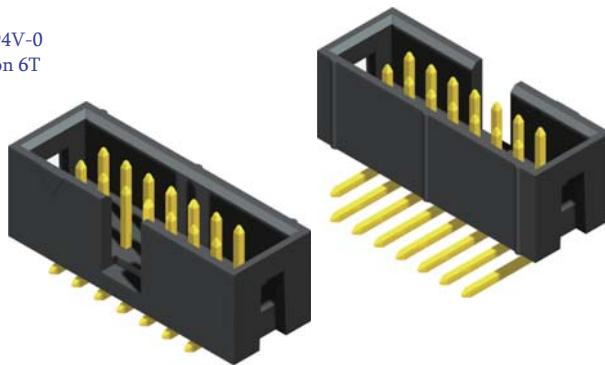

No. of contacts	Dim. A	Dim. B	Dim. C
6	15.24	12.90	5.08
8	17.90	15.44	7.62
10	20.30	18.00	10.16
12	22.98	20.52	12.70
14	25.40	23.09	15.24
16	27.95	25.65	17.78
20	33.05	30.75	22.85
24	38.15	35.85	27.94
26	40.65	38.35	30.48
30	45.70	43.45	35.56
34	50.80	48.50	40.64
40	58.40	56.15	48.26
44	63.85	61.39	53.34
50	71.12	68.80	60.96
60	83.85	81.50	73.66
64	88.90	86.60	78.74

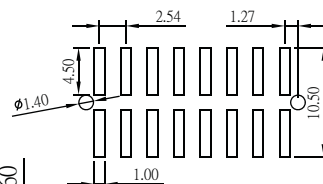
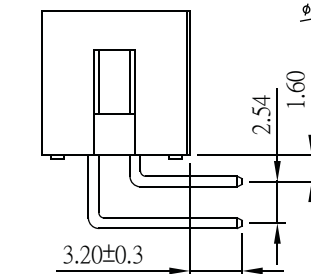
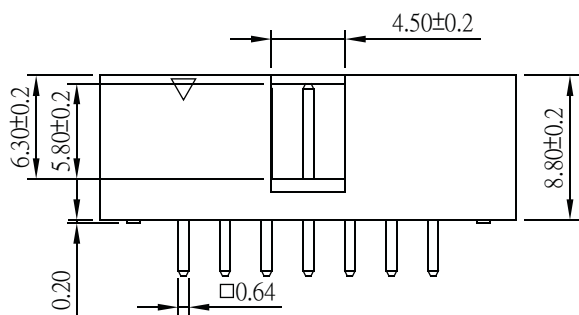
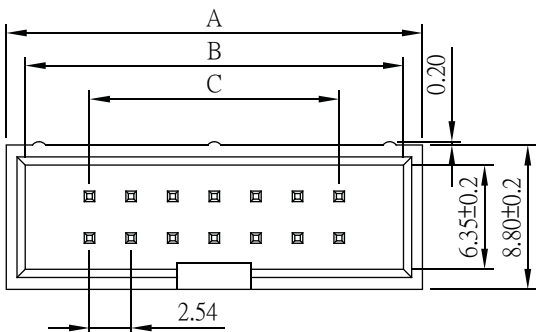

Recommended PCB Layout
(PCB TOLERANCE ±0.05)

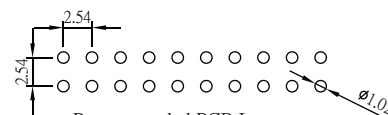
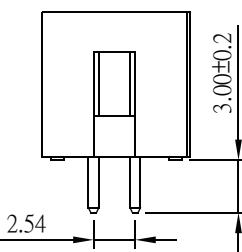

Recommended PCB Layout
(PCB TOLERANCE ±0.05)

ORDER INFORMATION

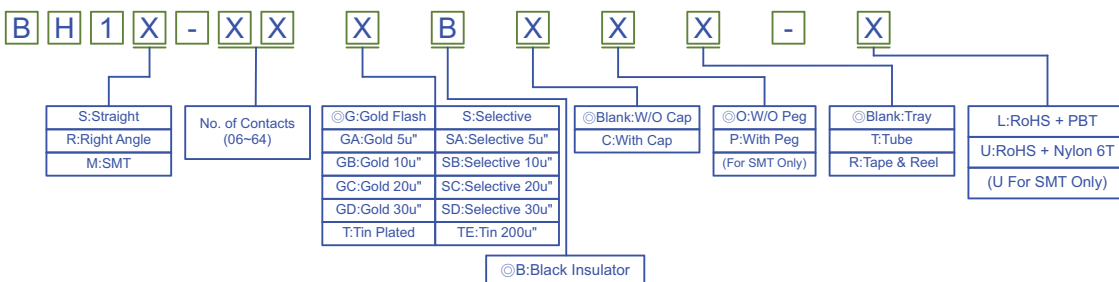

©Standard Recommended