

Tous droits strictement reserves. Reproduction ou communication a des tiers interdite sous quelque forme que ce soit sans autorisation ecrite du proprietaire. Propriete de c FCI. Droits de reproduction FCI.

**A**  
**FCI**



All rights strictly reserved. Reproduction or issue to third parties in any form whatever is not permitted without written authority from the proprietor. Property of FCI. Copyright FCI.

**B**

PRODUCT NO

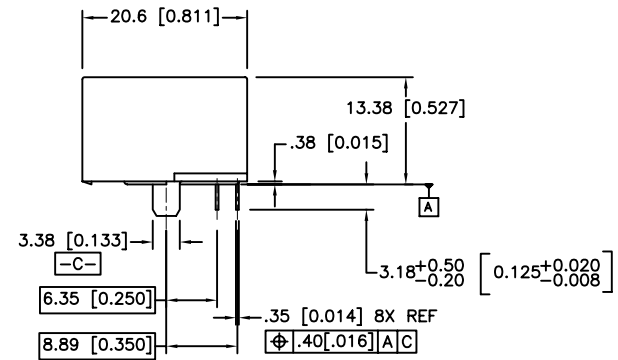
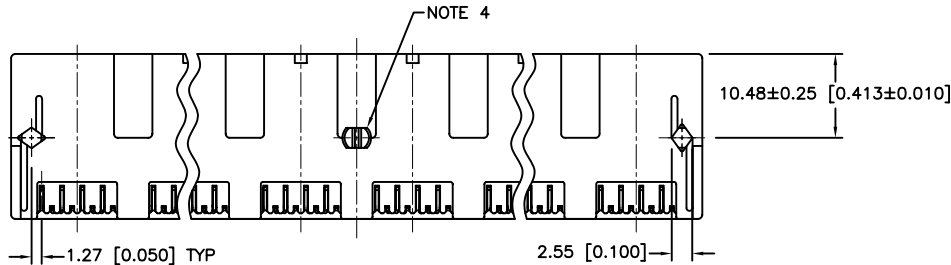
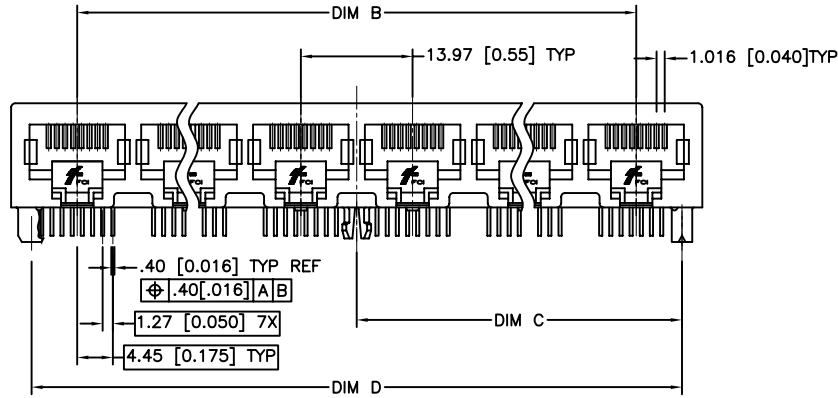
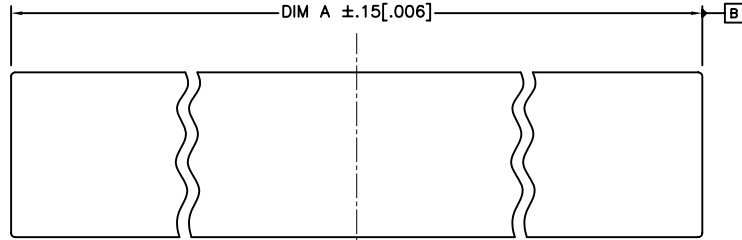
SEE TABLE



mat'l. code				tolerances unless otherwise specified				CUSTOMER COPY		 www.fciconnect.com	
ltr	ecn no	dr	date	linear	.XX±.13/.XXX ±.005	projection	title				
B	V91281	LP	6/9/99		.XXX±.051/.XXX ±.0020		MP SERIES, RJ45 SMT				
C	V92058	LP	10/20/99	angles	0° ±2°	MM/INCH	THRU HOLE DIAMOND PEG ASSY				
D	V92115	CGC	11/3/99			scale	product family MOD JACK				code
E	V00653	CSP	7/17/00	dr	L. POTTEIGER 11/30/98	1:1	size dwg no				-
F	V10984	BKB	3/8/01	enr	B.MARSHALL 11/30/98		A				74833
G	V12561	LP	10/23/01	chr	B.MARSHALL 11/30/98						sheet
H	M05-0074	MHT	4/23/05	appd	B.MARSHALL 11/30/98						1 of 3
sheet index	revision sheet	H	H	H							
		1	2	3							

**B**

Tous droits strictement reserves. Reproduction ou communication a des tiers interdite sous quelque forme que ce soit sans autorisation ecrite du proprietaire. Propriete de c FCI. Droits de reproduction FCI.

PRODUCT NO. ⑤	NO. OF PORTS	DIM A ±.15 [0.006]	DIM B	DIM C	DIM D	DIM E
74833-X02	2	30.48 [1.200]	13.97 [0.550]	12.70 [0.500]	25.40 [1.000]	32.11 [1.264]
74833-X03	3	44.45 [1.750]	27.94 [1.010]	19.69 [0.775]	39.37 [1.550]	46.08 [1.814]
74833-X04	4	58.42 [2.300]	41.91 [1.650]	26.67 [1.050]	53.34 [2.100]	60.05 [2.364]
74833-X05	5	72.39 [2.850]	55.88 [2.200]	33.66 [1.325]	67.31 [2.650]	74.02 [2.914]
74833-X06	6	86.36 [3.400]	69.85 [2.750]	40.64 [1.600]	81.28 [3.200]	87.99 [3.464]
74833-X07	7	100.33 [3.950]	83.82 [3.300]	47.63 [1.875]	95.25 [3.750]	101.96 [4.014]
74833-X08	8	114.30 [4.500]	97.79 [3.850]	54.61 [2.150]	109.22 [4.300]	115.93 [4.564]
74833-X09	9	128.27 [5.050]	111.76 [4.400]	61.60 [2.425]	123.19 [4.850]	129.90 [5.114]
74833-X10	10	142.24 [5.600]	125.73 [4.950]	68.58 [2.700]	137.16 [5.400]	143.87 [5.664]
74833-X11	11	156.21 [6.150]	139.70 [5.500]	75.57 [2.975]	151.13 [5.950]	157.84 [6.214]
74833-X12	12	170.18 [6.700]	153.67 [6.050]	82.55 [3.250]	165.10 [6.500]	171.81 [6.764]

NOTES:

- HOUSING MATL: HIGH TEMP. THERMOPLASTIC, COLOR BLACK, UL94V-0.
- CONTACT MATL: COPPER ALLOY  
MATING AREA PLATING: (SEE TABLE).  
SOLDER AREA PLATING: 2.54uM/100u" MIN TIN LEAD OVER NI.  
LEAD FREE OPTION:  
SOLDER AREA PLATING: 2.54uM/100u" MIN PURE TIN OVER NI.
- ALL DIMENSIONS IN MILLIMETERS AND INCHES.
- CENTER PEG FOR 8,10,12 PORTS ONLY.
- ADD LF SUFFIX AT THE END OF PART NUMBER FOR LEAD FREE OPTION.
- THE HOUSING WILL WITHSTAND EXPOSURE TO 260°C PEAK TEMPERATURE FOR 15 SECONDS IN A WAVE SOLDER APPLICATION WITH A 1.5mm MINIMUM THICK CIRCUIT BOARD. SEE APPLICATION NOTES/PROCEDURES IF THEY ARE AVAILABLE.
- THIS PRODUCT MEETS EUROPEAN UNION DIRECTIVES AND OTHER COUNTRY REGULATION AS DESCRIBED IN GS-22-008.
- PLATING OPTIONS:  
MAY BE EITHER GOLD OR GXT PLATED AT MANUFACTURER'S OPTION.

FCI

PLATING CODE X	PLATING ⑧
0	.76uM/30u" G.X.T.
3	.76uM/30u" GOLD
5	1.27uM/50u" GOLD

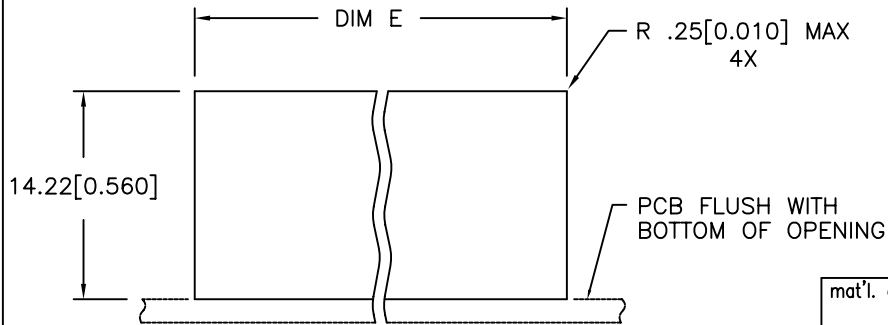

RECOMMENDED PANEL OPENING

mat'l. code				tolerances unless otherwise specified		CUSTOMER COPY	FCI www.fciconnect.com	
ltr	ecn no	dr	date	linear	projection	title		
				.X±.3/.XX ±.01		MP SERIES, RJ45 SMT THRU HOLE DIAMOND PEG ASSY		
				.XX±.13/.XXX ±.005				
				.XXX±.051/.XXXX ±.0020		product family MOD JACK code -		
				angles 0° ±2°				
				dr L. POTTEIGER 11/30/98	MM/INCH	size/ dwg no		
				enr B.MARSHALL 11/30/98	scale 1:1	A 74833		
				chr B.MARSHALL 11/30/98		sheet 2 of		
				appd B.MARSHALL 11/30/98				
sheet index	revision sheet							

All rights strictly reserved. Reproduction or issue to third parties in any form whatever is not permitted without written authority from the proprietor. Property of FCI. Copyright FCI.

Tous droits strictement reserves. Reproduction ou communication a des tiers interdite sous quelque forme que ce soit sans autorisation ecrite du proprietaire. Propriete de c FCI. Droits de reproduction FCI.

All rights strictly reserved. Reproduction or issue to third parties in any form whatever is not permitted without written authority from the proprietor. Property of FCI. Copyright FCI.

**FCI**

PRODUCT NO.  
SEE TABLE

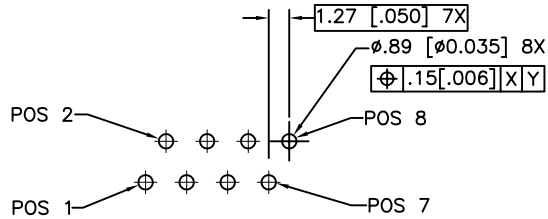

VIEW C  
SCALE 2/1  
TYPICAL FOOTPRINT

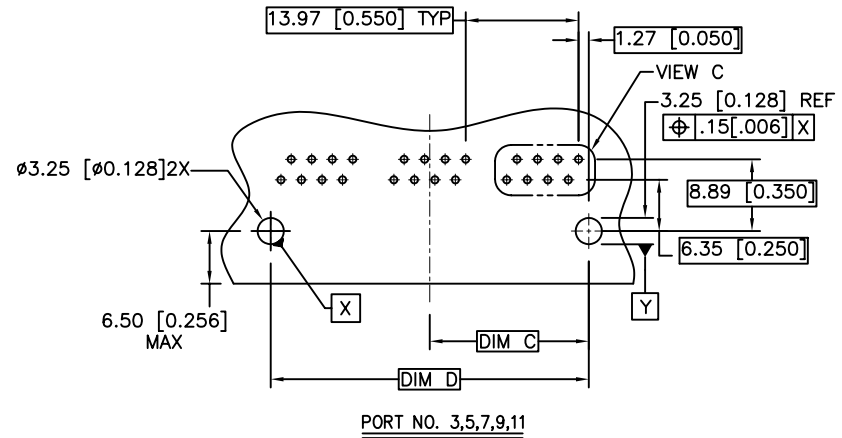
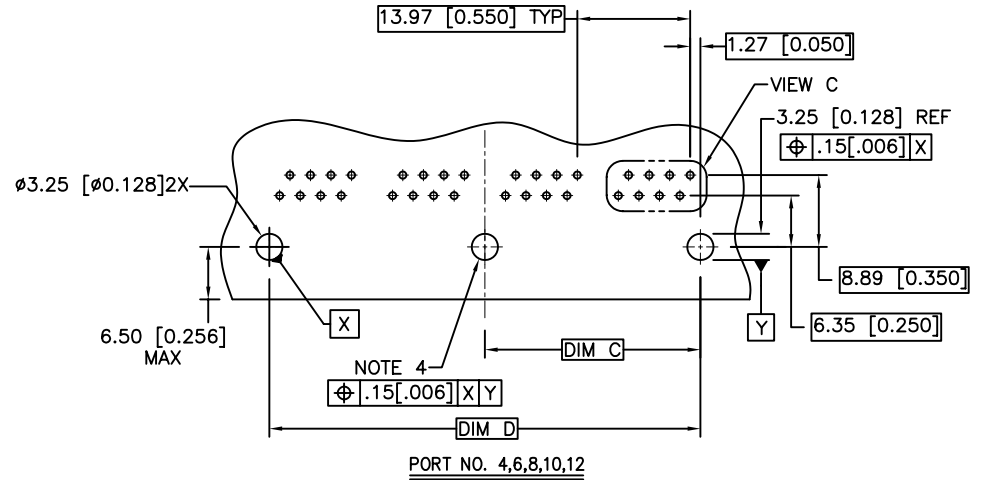
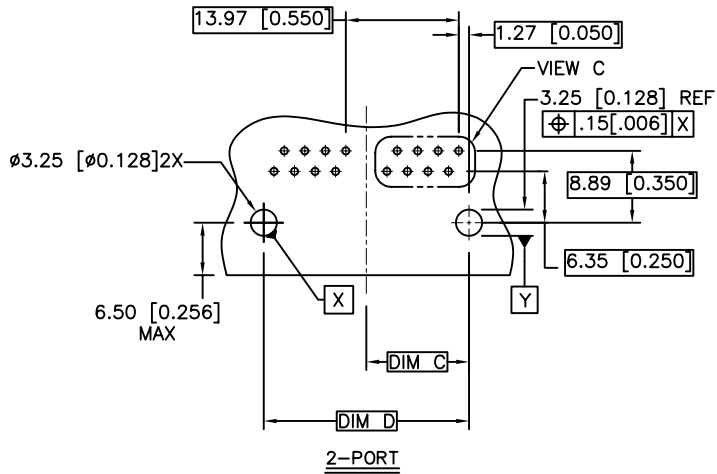

RECOMMENDED P.C.B LAYOUT  
AS VIEWED FROM TOP SIDE (COMPONENT SIDE)

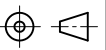
mat'l. code				tolerances unless otherwise specified		CUSTOMER COPY	 www.fciconnect.com
ltr	ecn no	dr	date	linear	.XX±.13/XXX ±.01		
H					.XXX±.051/XXX ±.0020	 MM/INCH	MP SERIES, RJ45 SMT THRU HOLE DIAMOND PEG ASSY
				angles	0° ±2°		product family
				dr	L. POTTEIGER 11/30/98	scale	code
				enr	B.MARSHALL 11/30/98	1:1	—
				chr	B.MARSHALL 11/30/98	size	dwg no
				appd	B.MARSHALL 11/30/98	A	74833
sheet index	revision sheet						sheet 3 of