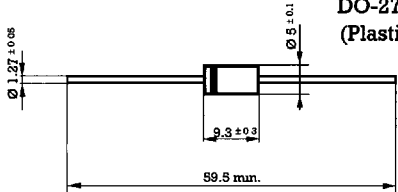

FAGOR 

FAGOR ELECTRONICS

3 Amp. Fast Recovery Silicon Diodes

T 03-15

<p>Dimensions in mm.</p>  <p>DO-201 AD DO-27 A (Plastic)</p>	<p>Voltage 100 to 1.000 V.</p> <p>Current 3.0 A. at 50°C.</p>
<p>Mounting instructions</p> <ol style="list-style-type: none"> 1. Min. distance from body to soldering point, 4 mm 2. Max. solder temperature, 350°C. 3. Max. soldering time, 3,5 sec. 4. Do not bend lead at a point closer than 3 mm. to the body. 	<ul style="list-style-type: none"> • Fast Recovery Diodes • Diffused junction • High surge capability • The plastic material carries U/L recognition 94 V-0 • Terminals: Axial Leads • Polanty: Color band denotes cathode

Maximum Ratings, according to IEC publication No. 134

		BY 396	BY 397	BY 398	BY 399	BY 399S
V_{RRM}	Peak recurrent and non recurrent reverse voltage (V)	100	200	400	800	1000
$I_{F(AV)}$	Forward current, R load at $T_{amb} = 50^\circ\text{C}$	3 A				
I_{FRM}	Recurrent peak forward current (A)	15 A				
I_{FSM}	10 ms. peak forward surge current at $T_j = 25^\circ\text{C}$	100 A				
t_{rr}	Max. reverse recovery time from $I_F = 0.5\text{ A}$ to $I_R = 1\text{ A}$ with $I_{tr} = 0.25\text{ A}$	250 ns				
T_j	Max. operating temperature	+ 150°C				
T_{stg}	Storage temperature range	- 65 to + 150 °C				

Electrical Characteristics at $T_{amb} = 25^\circ\text{C}$

V_F	Max. forward voltage drop at $I_F = 3\text{ A}$	1.3 V
I_R	Max. reverse current at V_{RRM} at 25°C	10 μA
R_{th-a}	Max thermal resistance ($l = 10\text{ mm.}$)	30° C/W

Characteristic Curves

FAGOR ELECTRONICS

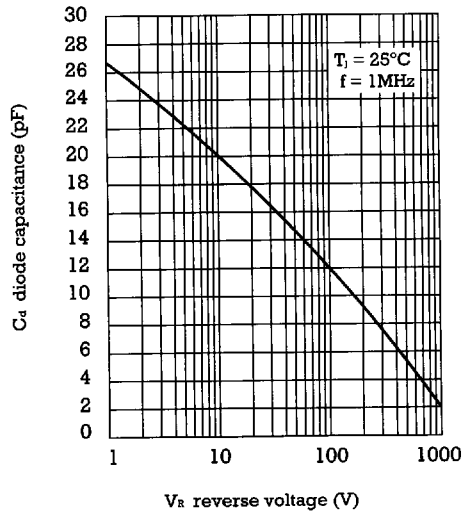
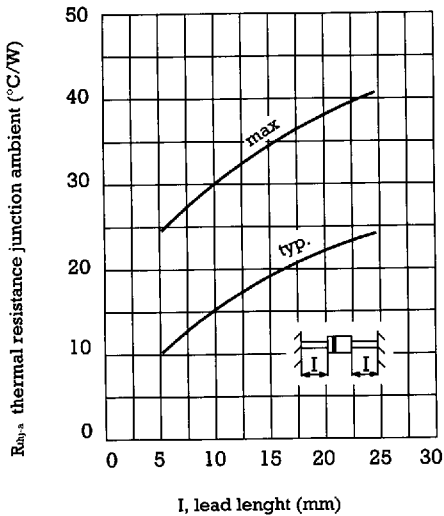
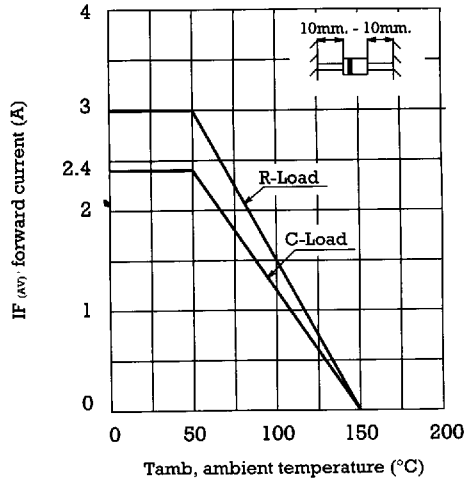
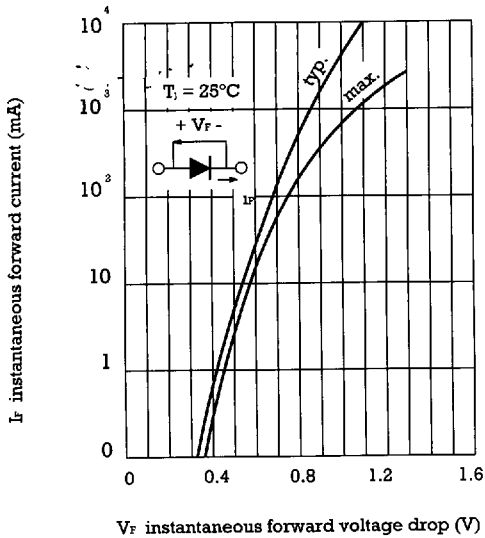

Package Outlines

Dimensions in mm.

1 DO-41
(Plastic)

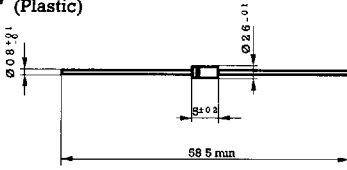

2 DO-15
F-126
58 A 2
(Plastic)

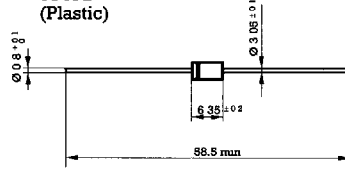

3 DO-27 A
DO-201 AD
(Plastic)

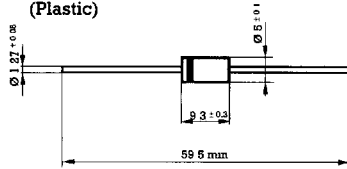

4 DO-201 AE
(Plastic)

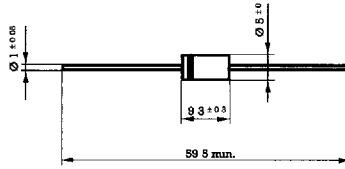

5 P-6
(Plastic)

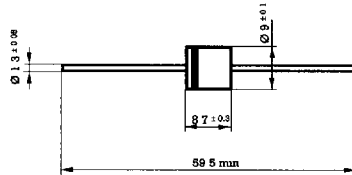

7

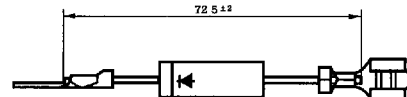
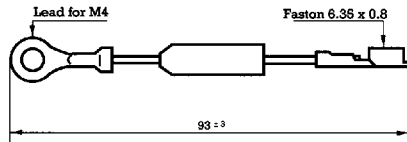

Suffix E1

6

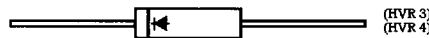
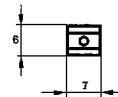
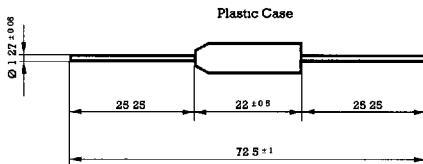

Package Outlines **Dimensions in mm**

8

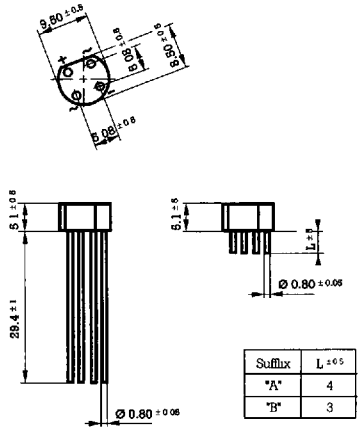

9

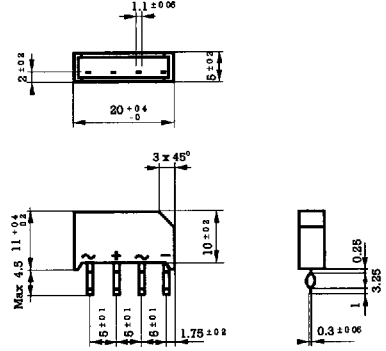

10

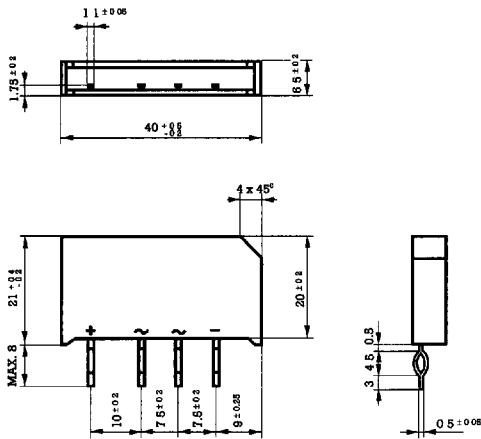

11

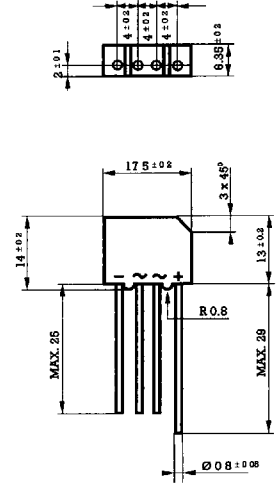

Packaging specifications

Dimensions in mm.

REEL PACKAGING (Under IEC-CEI 286-1 and RS-296 D)

CASE TYPE (OUTLINE)	REEL DIMENSIONS					UNITS PER REEL	APROX GROSS WEIGHT PER REEL PACKED
	K	b	S	m	a		
(1) DO41 (Plastic)	64	53 ±2	5 ±0.5	12	6 ±1	6000	2.5 kg (5.52 Lbs)
(2) DO15 (Plastic)	785	53 ±2	5 ±0.5	12	6 ±1	5000	2.3 kg (5.07 Lbs)
(3) DO201AD (Plastic) (4) DO201AE (Plastic)	11	53 ±2	10 ±0.5	1.2	6 ±1	1500	2 kg. (4.41 Lbs)
(5) P-6 (Plastic)	1127	53 ±2	10 ±0.5	1.2	6 ±1	1000	3 kg (6.61 Lbs)

REEL PACKAGING

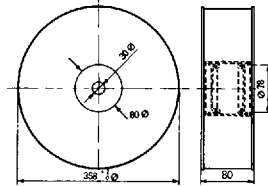
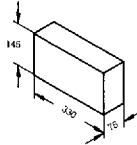
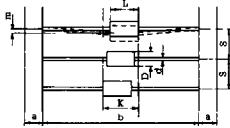

AMMO BOX PACKAGING (SUFFIX *AMP)

OUTLINES	BOX SIZE	UNITS PER BOX	APROX GROSS WEIGHT PER REEL PACKED
D0-41 (Plastic)	330 x 75 x 145	6000	2.20 kg (4.85 Lbs)
D0-15 (Plastic)	330 x 75 x 145	5000	2.20 kg (4.85 Lbs)
D0-201AD (Plastic)	330 x 75 x 145	1500	1.85 kg (4.08 Lbs)
D0-201ED (Plastic)	330 x 75 x 145	1500	1.85 kg (4.08 Lbs)
P-600	330 x 75 x 145	500	1.2 kg (2.65 Lbs)

DIL PACKAGING
ANTISTATIC PLASTIC TUBF

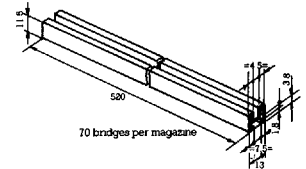

BOX PACKAGING

DEVICE TYPE (OUTLINE)	BOX SIZE	UNITS PER BOX	APROX GROSS WEIGHT
(6) (7) HVR3, HVR4 HVR062 (7) = Suffix E1	70 x 105 x 205	(6) 250 (7) 200	0.710 kg (1.560 Lbs)
(8) B C800, C1000, C1500 R, WL F, WF / (*A)	70 x 105 x 205	500 / (1.500)	0.650 kg (1.430 Lbs)
(9) B C1500/1000, C2000/1500	70 x 105 x 205	500	1.100 kg (2.425 Lbs)
(10) B . C3700/2200	70 x 105 x 205	100	1.100 kg (2.425 Lbs)
(10) B . C500/3300, C5000/3300-400	70 x 105 x 205	100	1.100 kg (2.425 Lbs)
(11) FBP, 2FBP	215 x 85 x 335	500	2.10 kg (4.62 Lbs)
(12) FBU 4 - 6 - 8	270 x 90 x 400	500	4.20 kg (9.23 Lbs)
(13) FB 10 - 15 - 25 - 35 - 50 B 10 - 15 - 25 - 35 - 50	70 x 105 x 205	50	0.850 kg (1.872 Lbs)
(14) FB 10L - 15L - 25L B 10L - 15L - 25L	35 x 135 x 205	20	0.350 kg (0.770 Lbs)
DF - M	540 x 145 x 110	5.600	4.0 kg (8.82 Lbs.)

Standard lead forming specifications

Dimensions in mm.

Plastic Cases

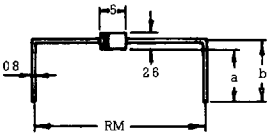
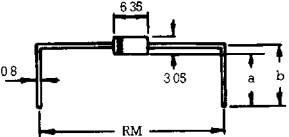
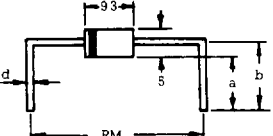
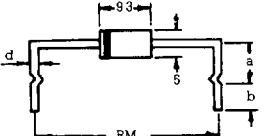
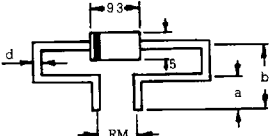
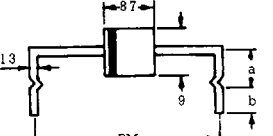
DO-41 	Type	Dimensions				
		a	b	RM		
		C2-3	3 ± 0.5	43 ± 0.5	10 ± 0.5	
		C2-5	10 ± 0.5	113 ± 0.5	10 ± 0.5	
	C2-8	4 ± 0.5	53 ± 0.5	10 ± 0.5		
DO-15 	Type	Dimensions				
		a	b	RM		
		C2-3	3 ± 0.5	45 ± 0.5	10 ± 0.5	
		C2-5	10 ± 0.5	115 ± 0.5	10 ± 0.5	
	C2-8	4 ± 0.5	55 ± 0.5	10 ± 0.5		
DO-201AD DO-27A (d = 1.27) 	DO-201AE (d = 1)	Type	Dimensions			
			a	b	RM	
			C2-1	35 ± 0.5	6 ± 0.5	15 ± 0.5
			C2-2	4 ± 0.5	65 ± 0.5	15 ± 0.5
			C2-4	7.5 ± 0.3	10 ± 0.3	17.8 ± 0.15
			C2-6	3.5 ± 0.5	6 ± 0.5	17.5 ± 0.5
			C2-7	4.5 ± 0.5	7 ± 0.5	21 ± 0.5
			C2-11	4.5 ± 0.5	7 ± 0.5	17.5 ± 0.5
			C2-12	12.5 ± 0.5	15 ± 0.5	17.5 ± 0.5
			C2-13	16 ± 0.5	18.5 ± 0.5	15.2 ± 0.5
			C2-14	7.5 ± 0.5	10 ± 0.5	15 ± 0.5
			C2-17	4 ± 0.5	8.5 ± 0.5	20 ± 0.5
			DO-201AD DO-27A (d = 1.27) 	DO-201AE (d = 1)	Type	Dimensions
a	b	RM				
C6-1	10 ± 0.5	5 ± 0.5				15.2 ± 0.5
C6-2	10 ± 0.5	5 ± 0.5				17.5 ± 0.5
C6-3	7 ± 0.5	5 ± 0.5				21 ± 0.5
C6-4	13.5 ± 0.5	5 ± 0.5				15.2 ± 0.5
	C6-5	10 ± 0.5	5 ± 0.5	20 ± 0.5		
DO-201AD DO-27A (d = 1.27) 	DO-201AE (d = 1)	Type	Dimensions			
			a	b	RM	
		C4-2	4.5 ± 0.3	10.5 ± 0.3	7.5 ± 0.5	
P-6 	Type	Dimensions				
		a	b	RM		
		C6-1	10 ± 0.5	5 ± 0.5	15.2 ± 0.5	
		C6-2	10 ± 0.5	5 ± 0.5	17.5 ± 0.5	
		C6-3	7 ± 0.5	5 ± 0.5	21 ± 0.5	
	C6-4	13.5 ± 0.5	5 ± 0.5	15.2 ± 0.5		