

< C band internally matched power GaAs FET >

MGFC39V7177A

7.1 – 7.7 GHz BAND / 8W

DESCRIPTION

The MGFC39V7177A is an internally impedance-matched GaAs power FET especially designed for use in 7.1 – 7.7 GHz band amplifiers. The hermetically sealed metal-ceramic package guarantees high reliability.

FEATURES

Class A operation

Internally matched to 50(ohm) system

- High output power
P1dB=8W (TYP.) @f=7.1 – 7.7GHz
- High power gain
GLP= 8.0dB (TYP.) @f=7.1 – 7.7GHz
- High power added efficiency
P.A.E.=28% (TYP.) @f=7.1 – 7.7GHz
- Low distortion [item -51]
IM3=-45dBc (TYP.) @Po=28dBm S.C.L

APPLICATION

- item 01 : 7.1 – 7.7 GHz band power amplifier
- item 51 : 7.1 – 7.7 GHz band digital radio communication

QUALITY

- IG

RECOMMENDED BIAS CONDITIONS

- VDS=10V • ID=2.4A Refer to Bias Procedure • RG=50ohm

Absolute maximum ratings (Ta=25°C)

Symbol	Parameter	Ratings	Unit
VGDO	Gate to drain breakdown voltage	-15	V
VGSO	Gate to source breakdown voltage	-15	V
ID	Drain current	7.5	A
IGR	Reverse gate current	-20	mA
IGF	Forward gate current	42	mA
PT *1	Total power dissipation	42.8	W
Tch	Channel temperature	175	°C
Tstg	Storage temperature	-65 to +175	°C

*1 : Tc=25°C

Electrical characteristics (Ta=25°C)

Symbol	Parameter	Test conditions	Limits			Unit	
			Min.	Typ.	Max.		
IDSS	Saturated drain current	VDS=3V, VGS=0V	-	-	7.5	A	
gm	Transconductance	VDS=3V, ID=2.2A	-	2	-	S	
VGS(off)	Gate to source cut-off voltage	VDS=3V, ID=20mA	-	-	-4.5	V	
P1dB	Output power at 1dB gain compression	VDS=10V, ID(RF off)=2.4A f=7.1 – 7.7GHz	38	39.5	-	dBm	
GLP	Linear Power Gain		7	8	-	dB	
ID	Drain current		-	-	3	A	
P.A.E.	Power added efficiency		-	28	-	%	
IM3 *2	3rd order IM distortion		-42	-45	-	dBc	
Rth(ch-c) *3	Thermal resistance		delta Vf method	-	-	3.5	°C/W

*2 : item -51 , 2 tone test, Po=28dBm Single Carrier Level , f=7.7GHz, delta f=10MHz

*3 : Channel-case

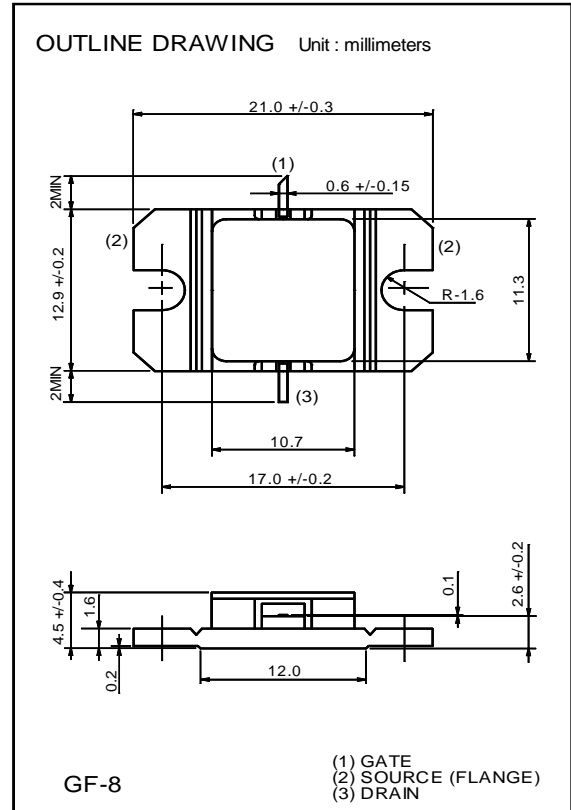

Keep Safety first in your circuit designs!

Mitsubishi Electric Corporation puts the maximum effort into making semiconductor products better and more reliable, but there is always the possibility that trouble may occur with them. Trouble with semiconductors may lead to personal injury, fire or property damage. Remember to give due consideration to safety when making your circuit designs, with appropriate measure such as (i) placement of substitutive, auxiliary circuits, (ii) use of non-flammable material or (iii) prevention against any malfunction or mishap.

Keep safety first in your circuit designs!

Mitsubishi Electric Corporation puts the maximum effort into making semiconductor products better and more reliable, but there is always the possibility that trouble may occur with them. Trouble with semiconductors may lead to personal injury, fire or property damage. Remember to give due consideration to safety when making your circuit designs, with appropriate measures such as (i) placement of substitutive, auxiliary circuits, (ii) use of non-flammable material or (iii) prevention against any malfunction or mishap.

Notes regarding these materials

- These materials are intended as a reference to assist our customers in the selection of the Mitsubishi semiconductor product best suited to the customer's application; they do not convey any license under any intellectual property rights, or any other rights, belonging to Mitsubishi Electric Corporation or a third party.
- Mitsubishi Electric Corporation assumes no responsibility for any damage, or infringement of any third-party's rights, originating in the use of any product data, diagrams, charts, programs, algorithms, or circuit application examples contained in these materials.
- All information contained in these materials, including product data, diagrams, charts, programs and algorithms represents information on products at the time of publication of these materials, and are subject to change by Mitsubishi Electric Corporation without notice due to product improvements or other reasons. It is therefore recommended that customers contact Mitsubishi Electric Corporation or an authorized Mitsubishi Semiconductor product distributor for the latest product information before purchasing a product listed herein.

The information described here may contain technical inaccuracies or typographical errors. Mitsubishi Electric Corporation assumes no responsibility for any damage, liability, or other loss rising from these inaccuracies or errors.

Please also pay attention to information published by Mitsubishi Electric Corporation by various means, including the Mitsubishi Semiconductor home page (<http://www.MitsubishiElectric.com/>).

- When using any or all of the information contained in these materials, including product data, diagrams, charts, programs, and algorithms, please be sure to evaluate all information as a total system before making a final decision on the applicability of the information and products. Mitsubishi Electric Corporation assumes no responsibility for any damage, liability or other loss resulting from the information contained herein.
- Mitsubishi Electric Corporation semiconductors are not designed or manufactured for use in a device or system that is used under circumstances in which human life is potentially at stake. Please contact Mitsubishi Electric Corporation or an authorized Mitsubishi Semiconductor product distributor when considering the use of a product contained herein for any specific purposes, such as apparatus or systems for transportation, vehicular, medical, aerospace, nuclear, or undersea repeater use.
- The prior written approval of Mitsubishi Electric Corporation is necessary to reprint or reproduce in whole or in part these materials.
- If these products or technologies are subject to the Japanese export control restrictions, they must be exported under a license from the Japanese government and cannot be imported into a country other than the approved destination.
Any diversion or re-export contrary to the export control laws and regulations of Japan and/or the country of destination is prohibited.
- Please contact Mitsubishi Electric Corporation or an authorized Mitsubishi Semiconductor product distributor for further details on these materials or the products contained therein.