

2 • ROW

Cable or Board to Crimp Removable

.075"

RM2

10 thru 100 Contacts

RM212-020-101-5500

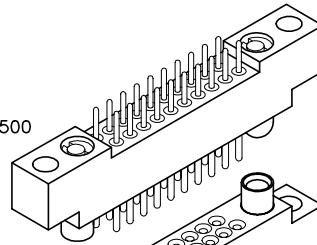

RM222-020-581-5500

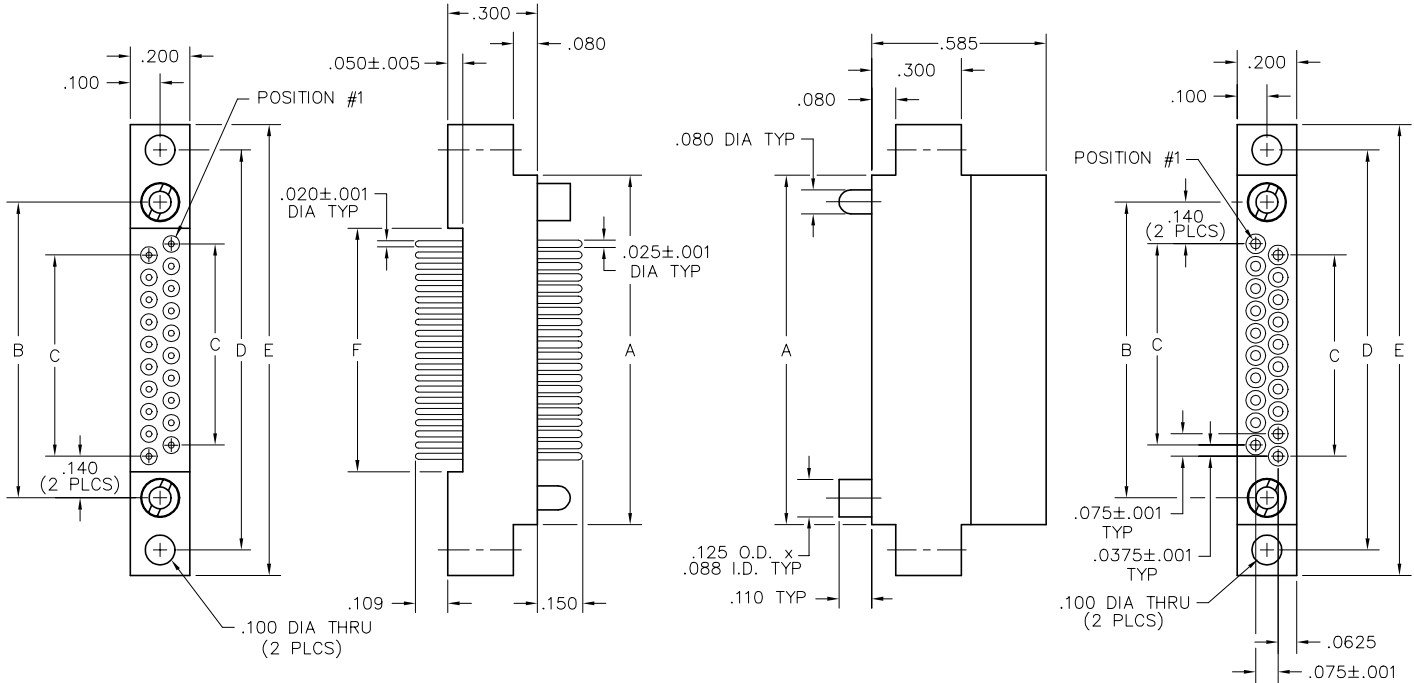
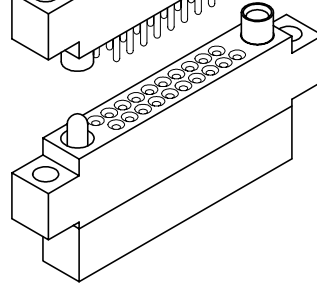

PLUG

RECEPTACLE

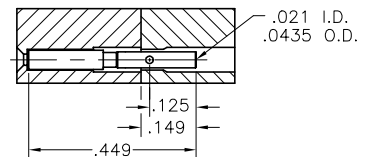
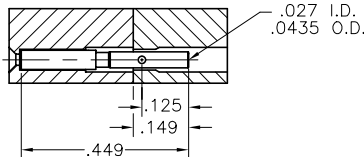
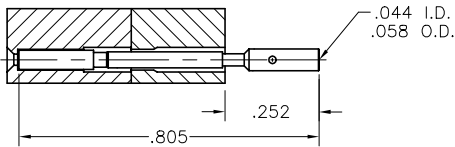

20-22 AWG

24-26 AWG

28-30 AWG

NOTE:

When using crimp contacts with 20 gage barrel, barrel must be cut off prior to removing contact from connector body.

CRIMP REMOVABLE CONTACTS	
SIZE	PART NUMBER
20-22 AWG	RM200-000-571-0000
24-26 AWG	RM200-000-581-0000
28-30 AWG	RM200-000-591-0000

DIMENSIONS					
SIZE	A	B	C	D	E
10	.797	.617	.300	.967	1.137
20	1.172	.992	.675	1.342	1.512
30	1.547	1.367	1.050	1.717	1.887
40	1.922	1.742	1.425	2.092	2.262
50	2.297	2.117	1.800	2.467	2.637
60	2.672	2.492	2.175	2.842	3.012
70	3.047	2.867	2.550	3.217	3.387
80	3.422	3.242	2.925	3.592	3.762
90	3.797	3.617	3.300	3.967	4.137
100	4.172	3.992	3.675	4.342	4.512

PLUG: RM212-020-101-5500
RECEPTACLE: RM222-020-581-5500
 XXXXX-XXX-XXX-XXXX

PLUG		RECEPTACLE	
SERIES			
RM .075" Screw Machine PC Connector		RM .075" Screw Machine PC Connector	
BODY			
2	2-Row	2	2-Row
BODY STYLE:		BODY STYLE:	
1	Plug, straight, with mounting ears	2	Receptacle, straight, with mounting ears
3	Plug, straight, without mounting ears	4	Receptacle, straight, without mounting ears
BODY MATERIAL:		BODY MATERIAL:	
2	Polyphenylene sulfide (PPS)	2	Polyphenylene sulfide (PPS)
SIZE			
010, 020, 030, 040, 050, 060, 070, 080, 090, 100		010, 020, 030, 040, 050, 060, 070, 080, 090, 100	
CONTACTS			
TYPE CONTACTS/TERMINATIONS:		TYPE CONTACTS/TERMINATIONS:	
10	Pin, straight, dip solder, .109" x .020" dia	00	Contacts not supplied
11	Pin, straight, solder cup	57	Socket, straight, crimp removable (20-22 AWG)*
12	Pin, straight, dip solder, .140" x .020" dia	58	Socket, straight, crimp removable (24-26 AWG)*
13	Pin, straight, dip solder, .172" x .020" dia	59	Socket, straight, crimp removable (28-30 AWG)*
15	Pin, straight, flex, .093" x .017" dia		
PLATING OPTIONS:		PLATING OPTIONS:	
1	Gold plated termination	1	Gold plated termination
2	Pre-tinned termination (except solder cup or flex)		
HARDWARE			
STYLE OF HARDWARE: (See R-41 & R-42 for all options)		STYLE OF HARDWARE: (See R-41 & R-42 for all options)	
0256	None	0256	None
55	Guide set	55	Guide set
57	Two guide pins	57	Two guide pins
58	Two guide sockets	58	Two guide sockets
29	Fixed jackset	29	Fixed jackset
30	Fixed jackset, reversed	30	Fixed jackset, reversed
19	Two fixed jackscrews	19	Two fixed jackscrews
20	Two fixed jacksockets	20	Two fixed jacksockets
59	Hex turning jackset, .200"	59	Hex turning jackset, .200"
60	Hex turning jackset, reversed, .200"	60	Hex turning jackset, reversed, .200"
61	Two hex turning jackscrews, .200"	61	Two hex turning jackscrews, .200"
62	Two hex turning jacksockets, .200"	62	Two hex turning jacksockets, .200"
64	Turning jackset, .490"	64	Turning jackset, .490"
65	Turning jackset, reversed, .490"	65	Turning jackset, reversed, .490"
66	Two turning jackscrews, .490"	66	Two turning jackscrews, .490"
67	Two turning jacksockets, .490"	67	Two turning jacksockets, .490"
POLARIZATION:		POLARIZATION	
00	None	00	None
01	thru 68 are special identifiers, see R-38	01	thru 68 are special identifiers, see R-38
70	Same configuration as 01 without Loctite® (To be keyed by customer)	70	Same configuration as 01 without Loctite® (To be keyed by customer)

- * Full compliment of crimp removable sockets packaged with connectors
1. Crimp tool - AirBorn part number: CDG4601, Mil Spec number M22520/2-01
 2. Crimp positioner - AirBorn part number: CDG4602 (24-26 AWG and 28-30 AWG)
CDG4603 (20-22 AWG)
 3. Crimp removal tool - AirBorn part number: CDG8161 (All AWGs)
 4. Crimp contact part number on previous page.

2 • ROW

Right Angle PTH Plug Straight PTH Plug

.075"

RM2

10 thru 100 Contacts

Recommended
Board Layout

DIMENSIONS			
SIZE	A	B	C
10	.967	.337	.300
20	1.342	.712	.675
30	1.717	1.087	1.050
40	2.092	1.462	1.425
50	2.467	1.837	1.800
60	2.842	2.212	2.175
70	3.217	2.587	2.550
80	3.592	2.962	2.925
90	3.967	3.337	3.300
100	4.342	3.712	3.675

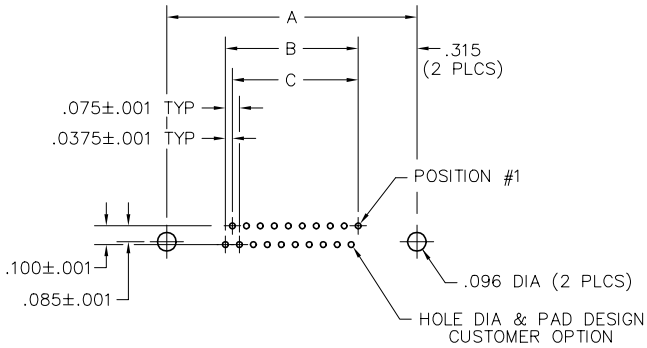
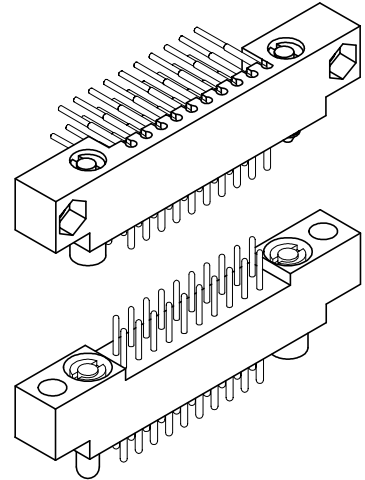

RIGHT ANGLE PTH PLUG
PC BOARD VIEWED FROM COMPONENT SIDE

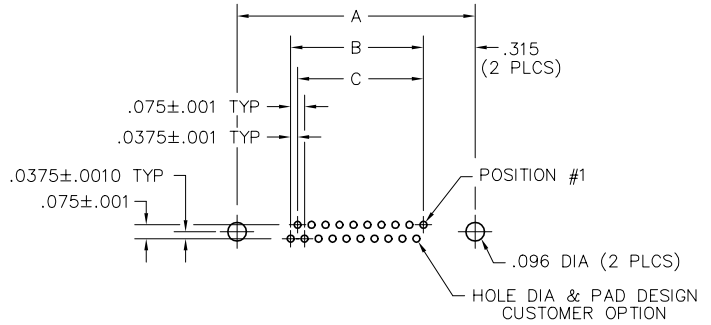

STRAIGHT PTH PLUG
PC BOARD VIEWED FROM COMPONENT SIDE

SIZE	CONTACT ID	SIZE	CONTACT ID
10		60	
20		70	
30		80	
40		90	
50		100	